



Displacement sensor control unit UQ1 series

User's manual

Introduction

Thank you for purchasing the displacement sensor I/F unit UQ1 series. Before using this product, please confirm this product is what you need.

- Please read this manual thoroughly and keep this manual at hand for proper use.
- When you lost this manual or had any questions and what you don't understand, please contact our distributor that you purchased this product from.
- Copyright of any trade marks or registered marks shown on this manual are owned by each those companies.
- Copyright of this manual is owned by Optex-FA Co., Ltd. and protected by copyright law. Copying of this manual is prohibited.

● **Warranty**



When you found any malfunctions of this product, please contact our distributor that you purchased this product from. Warranty terms to be contracted between the customer and the distributor.

Safety precautions

Before using this product, please read this manual carefully so that you can use this product correctly without any problems.

The important information described on this manual is to protect your health and property. Do not apply any other installing or operating procedure other than that described in this manual.

In this manual, safety precautions are classified into two levels as follows.

 Warning	Indicates that incorrect handling may cause hazardous conditions, resulting in death or severe injury.
 Caution	Indicates that incorrect handling may cause hazardous conditions, resulting in minor or moderate injury or property damage.

Make sure to keep to following precautions

Warning

- This product can not be used as protective equipment for the purpose of protecting human body.
- Disassembling or modification of the product may cause injury, fire or electric shock.
- When you felt smoke or foreign odor, please power off the product immediately and inform the distributor that you purchased the product from.
- Please use the product under rated voltage.
- Touching the product and cable with wet hand may cause electric shock.
- Please make sure that this product is used with specified sensor head.
- Please do not wire, connect or disconnect while power supply is on.

Installing precaution

Warning

- **Installing in the following places may cause breakdown, fire or electric shock.**
 - a. Humid place
 - b. High temperature place
 - c. Dusty place
 - d. Bad ventilation place
 - e. Very dry place with static electricity
 - f. A place with corrosive gas or flammable gas
 - g. A place with splash of water, oil or chemical
 - h. A place with vibration or shock
- **Please wire while power supply is off.**

Caution

- **Please do not wire with high voltage cable or high power line. It cause noise and malfunction. Please also shorten the wire as much as possible.**
 - **Please prevent tension on the wire so that not to destroy the product.**
-

Contents

Introduction.....	ii
Safety precautions.....	iii
Contents	v
1	
General description	1-1
1.1 Feature.....	1-2
1.2 Procedure summary.....	1-3
1.2.1 Procedure summary up to start up	1-3
1.2.2 UQ1 series data flow	1-3
1.3 Usable sequencer	1-7
1.4 Specifications	1-8
2	
System installation.....	2-1
2.1 System installation	2-2
2.1.1 FirST communication.....	2-3
2.2 Display/Terminal/Wiring.....	2-4
2.2.1 Display/Terminal	2-4
2.2.2 Wiring.....	2-7
2.2.3 Input / Output schematic.....	2-11
3	
Function.....	3-1
3.1 Shared memory and X/Y device	3-2
3.1.1 X/Y device table	3-2
3.1.2 Shared memory table	3-3
3.1.3 X / Y device in detail	3-10
3.1.4 Parameters in shared memory	3-14
3.2 Parameters in detail	3-16
3.2.1 Sensor head setup.....	3-16
3.2.2 High speed mode.....	3-21
3.2.3 Q1~Q5 / Calculation setup.....	3-22
3.2.4 Setup of other parameters	3-28
3.2.5 Input / Output setup	3-30
3.2.6 Storage setup	3-32
3.2.7 Initializing	3-36
3.2.8 Bank setup.....	3-36

3.2.9	Q1 ~ Q5 result	3-37
3.2.10	Error status	3-41
3.2.11	Unit status	3-42
3.2.12	Loaded data	3-43
3.2.13	Waveform data	3-44
3.3	Hold mode and process	3-45

4

Setup software.....	4-1
4.1 Setup software general description.....	4-2
4.1.1 Recommended system requirements.....	4-2
4.1.2 Software general description.....	4-2
4.1.3 Software overview.....	4-3
4.1.4 Menu.....	4-4
4.1.5 Tool bar	4-4
4.2 Software installation	4-5
4.2.1 Installation procedure	4-5
4.2.2 Uninstallation procedure	4-7
4.2.3 Starting up setup software "UQ1 Navigator".....	4-8
4.3 Storing / Loading setup parameters.....	4-9
4.3.1 New project.....	4-9
4.3.2 Open project	4-9
4.3.3 Save project	4-9
4.4 Connection with the sequencer.....	4-11
4.4.1 Set destination	4-11
4.4.2 USB driver setting	4-12
4.4.2 Readout setup	4-15
4.4.3 Write setup.....	4-16
4.5 Setup procedure	4-17
4.5.1 Unit setup	4-17
4.5.2 Operation of setup screen	4-19
4.5.3 Calculation setup (Direct)	4-21
4.5.4 Calculation setup (Application)	4-24
4.5.5 Sensor head setup	4-28
4.5.6 Calibration setup	4-30
4.5.7 I/O setup	4-32
4.5.8 Control output setup	4-34
4.5.9 Storage setup	4-36
4.6 Confirming process	4-38
4.6.1 Measured result	4-38
4.6.2 Storage data	4-40
4.6.3 Waveform data.....	4-43

5

Trouble shooting 5-1

- 5.1.1 Function..... 5-2
- 5.1.2 Measurement 5-3
- 5.1.3 UQ1 shared memory , X/Y device..... 5-5
- 5.1.4 Setup software 5-7
- 5.1.5 Term..... 5-8

6

Addendum 6-1

- 6.1.1 Cutoff frequency of the filter 6-2

1

General description

1.1 Feature

UQ1 series is interface unit that communicates with laser displacement sensor CD5/CD33 series and gets the measurement result into "Shared Memory".

Following are the features.

- 1) UQ1 communicates with CD5/CD33 series and gets measurement result automatically.
- 2) UQ1 series setups CD5/CD33 series, getting measurement result from CD5/CD33 series, calculation and judges so rudder program is not needed for those process.
- 3) UQ1 series has control output terminal built-in so it works very fast, response time: 100us min., independently of PLC sequencer.
- 4) Setup software that programs UQ1 series at start up is available. Please contact the distributor.
- 5) You can connect up to two CD5/CD33 series sensor heads to a UQ1 series unit. It is cost effective and also it's easy to program calculation of thickness for example.
- 6) UQ1 series can communicate with other UQ1 series through "FIRST communication", high speed infrared communication, without using Q-bus.

1.2 Procedure summary

1.2.1 Procedure summary up to start up

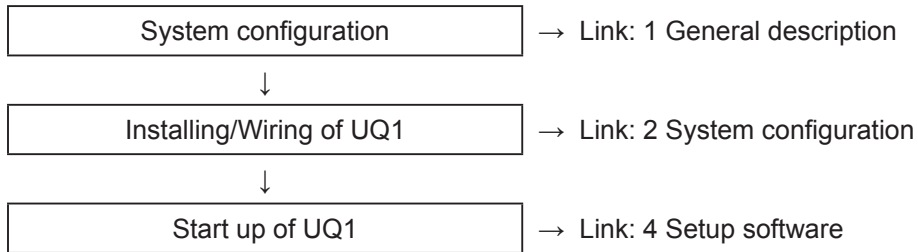

1.2.2 UQ1 series data flow

Data is processed in UQ1 series as following.

● In operation

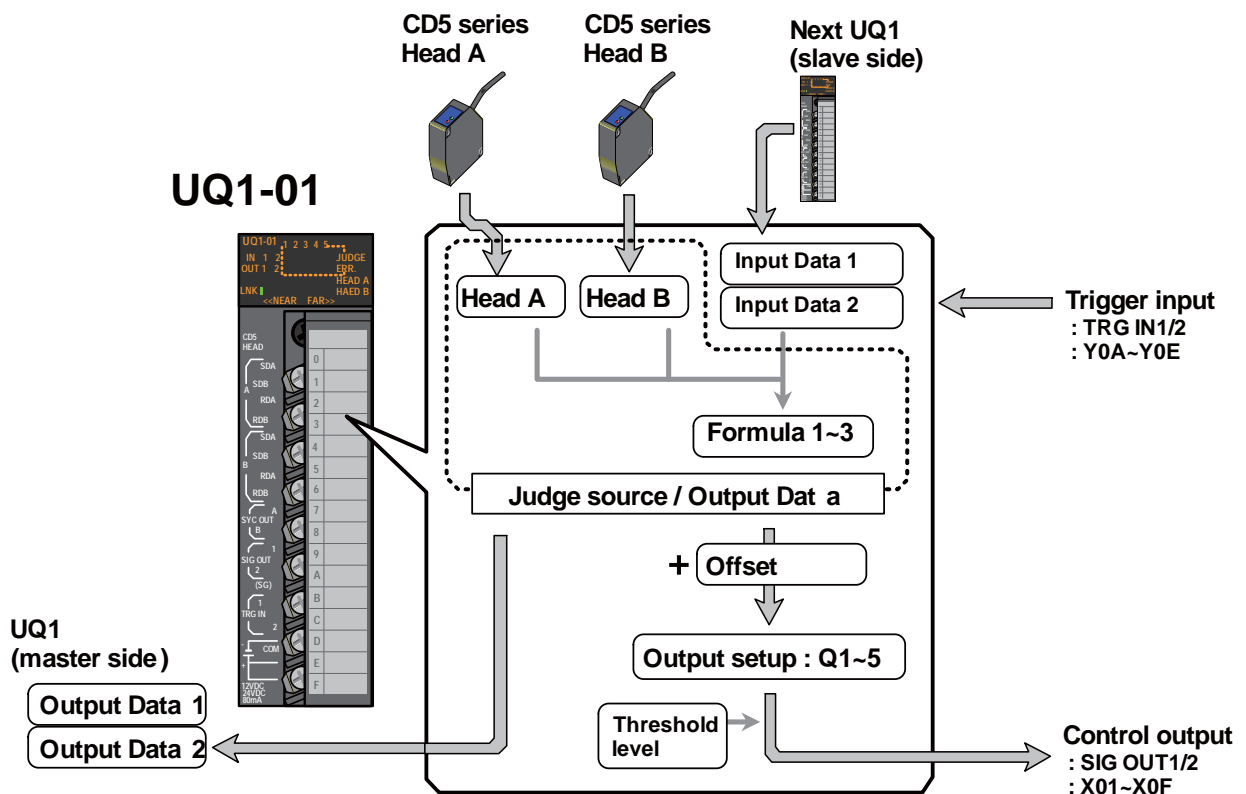

* The data flow above shows about UQ1-01. CD33 series sensor heads will be used for UQ1-02.

1 Input data

UQ1 series unit can get following data.

- Head A : Measurement result of CD5/CD33 series sensor head A connected to UQ1-01/02
- Head B : Measurement result of CD5/CD33 series sensor head B connected to UQ1-01/02
- Received data 1/2: Transmitted data specified at "Transmission Data setup" from the UQ1-01/02 connected to slave side.

Link: [2.1.1 FlrST communication]

2 Data calculation

Received data can be calculated according to the setup at "Formula 1~3 (shared memory address 42~101)".

Link: [3.2.3 Judge setup]

3 Control output

You can set threshold for the control output.

5 control outputs, Q1~Q5, are available.

You can specify which data to refer for the control output from Head A/B, Input Data 1/2 and Formula 1~3.

You can add "offset" on specified measured result.

Tips

- When Sensor head or Input Data assigned in the calculation formula is not connected, "0" will be applied.
 - When you assign Sensor head that is not connected as the source of control output Q1~Q5, it will cause the error X1B~X1F. Although, there won't be any error if you assign next UQ1 unit at slave side as Input Data.
 - When an error is occurred, you have to re-start up the power supply or set "Y16 error release" ON to release the error.
 - UQ1 series continues the procedure from getting measured result up to output every constant period. This period is specified by "Process time, at shared memory address 327 (us)" rounding out every 100us. For example, when "Process time" is 140 (us), the constant period is 200 us.
 - You can refer measured result of Sensor head A/B, Input Data 1/2, Calculation result 1~3 and control output Q1~Q5 through shared memory.
 - FlrST communication will be done every updating period. When multiple UQ1 units are connected, the data is transferred through the units every updating period so total delay will be updating period * unit number connected to master unit.
-

● Setup

Setup procedure is as follows.

1 Change setup parameters in shared memory

Setup parameters in shared memory are at following address.

Link: [3.1.4 Parameters in shared memory]

- Common setup parameters: address 0~126
- Parameters by Bank: address 128~159

Change these parameters accordingly.

Please refer “3 Process” for detailed of each parameter.

2 Activate Y (output device)

Activate Y (output device) accordingly.

Y10 Transfer setup parameters from shared memory to internal memory and CD5/CD33

Transfer setup parameters from shared memory address 0~127
to internal memory and CD5/CD33.

Switch the Bank according to the Bank number specified at shared memory address 102.

(Please refer “Y08 Switching Bank”)

X10 (input device: BUSY) will be ON while this process.

Y08 Switching Bank

Switching Bank

Readout setup data of the Bank number specified at shared memory address 102.

Transfer the parameter data corresponding from Bank memory into shared memory
address 128~159 and internal memory.

X12 (input device: BUSY) will be ON while this process.

Y11 Storing Bank setup

Store the setup data into specified Bank memory.

Transfer the setup data from shared memory address 128~159

into the Bank memory which number is specified at shared memory address 102.

X11 (input device: BUSY) will be ON while this process.

Tips

- Data in the shared memory will be lost when the power is off. By activating Y10 and Y11, the ROM in the unit will be updated with the data in the shared memory not only the internal memory in the unit.
 - When the unit is powered up without storing the data in the shared memory, it reboots with the data in the ROM in the unit.
 - While BUSY is activated, the unit stops getting data from CD5/CD33, calculating and output.
 - Storage transfer start pointer (shared memory address 124, 125) is reflected without activating any Y (output device). Bank number (shared memory address 102) is reflected by activating Y08 Switching Bank (output device). Please refer [3.2.6 Storage setup] about storage.
 - While BUSY (X11~15) is activated, you won't be able to get correct data from the shared memory corresponding to the BUSY.
-

1.3 Usable sequencer

Usable sequencer (CPU unit) is as follows.

CPU unit can be used with UQ1	Basic model QCPU
	High Performance model QCPU
	Process CPU
	Redundant CPU(*)
	Universal model QCPU
	Remote I/O station
CPU unit can not be used with UQ1	C Controller unit
	Safety CPU

* Can not install on main base unit and also can not proceed online module replacement.

1.4 Specifications

Part number		UQ1-01
Sampling period		Min. 100 μ s
I/O points to occupy		32 points (I/O: Intelligent 32 points)
Communication method (between UQ1 units)		Infrared
Terminal block	Usable wire	Core: 0.3 ~ 0.75mm ² (Outer diameter: Max. 2.8mm)
	Usable Solderless terminal	R1.25-3 without sleeve
Communication I/F (between UQ1 and CD5)	Number of head	Max. 2 heads
	Protocol	RS-422
	Baud rate	921.6kbps
	Cable	DOL-1212-G05M (5m sensor head cable)
	Cable extension	Up to 50m using optional extension cable (unbundled)
Control output	Mode	NPN open collector
	Output voltage	DC12-24V (\pm 10%)
	Output current	80mA (DC12-24V)
	Residual voltage	Max. 1.0V
	Leak current	Max. 0.2mA
	Protection	Over current protection circuitry
Trigger input	Logic	ON by connecting to GND (0V)
	ON voltage	Max. 1.0V
	OFF voltage	Min. 2.0V
	Input impedance	Approximately 10k Ω
Function		Setup sensor head, Control output, Calculation, Hold function Filter function, Bank setup, Storage function
EEPROM overwriting limit		Max. 1000,000 times for same memory area
DC5V current consumption		Max. 0.5A
Noise tolerance		500Vp-p (simulator), Noise width: 1 μ s Fast transient noise 1kV (IEC 61000-4-4)
Insulation resistance		Min. 10M Ω (insulation resistance meter)
Protection category		IP2X
Operating Temp. / Humid.		-10 ~ +55 $^{\circ}$ C / 35 ~ 85%RH (non condensation)
Storage Temp. / Humid.		-20 ~ +70 $^{\circ}$ C / 35 ~ 85%RH (non condensation)
Vibration resistance		10 ~ 55Hz Double amplitude 1.5mm 2 hours per X, Y, Z axis
Dimensions		98(H) * 27.4(W) * 90(D) [mm]
Weight		Approximately 150g

Part number		UQ1-02
Sampling period		Min. 100 μ s
I/O points to occupy		32 points (I/O: Intelligent 32 points)
Communication method (between UQ1 units)		Infrared
Terminal block	Usable wire	Core: 0.3 ~ 0.75mm ² (Outer diameter: Max. 2.8mm)
	Usable Solderless terminal	R1.25-3 without sleeve
Communication I/F (between UQ1 and CD33)	Number of head	Max. 2 heads
	Protocol	RS-422
	Baud rate	256kbps
Control output	Mode	NPN open collector
	Output voltage	DC12-24V (\pm 10%)
	Output current	80mA (DC12-24V)
	Residual voltage	Max. 1.0V
	Leak current	Max. 0.2mA
	Protection	Over current protection circuitry
Trigger input	Logic	ON by connecting to GND (0V)
	ON voltage	Max. 1.0V
	OFF voltage	Min. 2.0V
	Input impedance	Approximately 10k Ω
Function		Setup sensor head, Control output, Calculation, Hold function Filter function, Bank setup, Storage function
EEPROM overwriting limit		Max. 1000,000 times for same memory area
DC5V current consumption		Max. 0.5A
Noise tolerance		500Vp-p (simulator), Noise width: 1 μ s Fast transient noise 1kV (IEC 61000-4-4)
Insulation resistance		Min. 10M Ω (insulation resistance meter)
Protection category		IP2X
Operating Temp. / Humid.		-10 ~ +55 $^{\circ}$ C / 35 ~ 85%RH (non condensation)
Storage Temp. / Humid.		-20 ~ +70 $^{\circ}$ C / 35 ~ 85%RH (non condensation)
Vibration resistance		10 ~ 55Hz Double amplitude 1.5mm 2 hours per X, Y, Z axis
Dimensions		98(H) * 27.4(W) * 90(D) [mm]
Weight		Approximately 150g

* Cable for connector type CD33 are available; DOL-1208-G02M/5M (2m/5m)

2

System installation

2.1 System installation

UQ1 series are installed on Q Bus as following example picture.

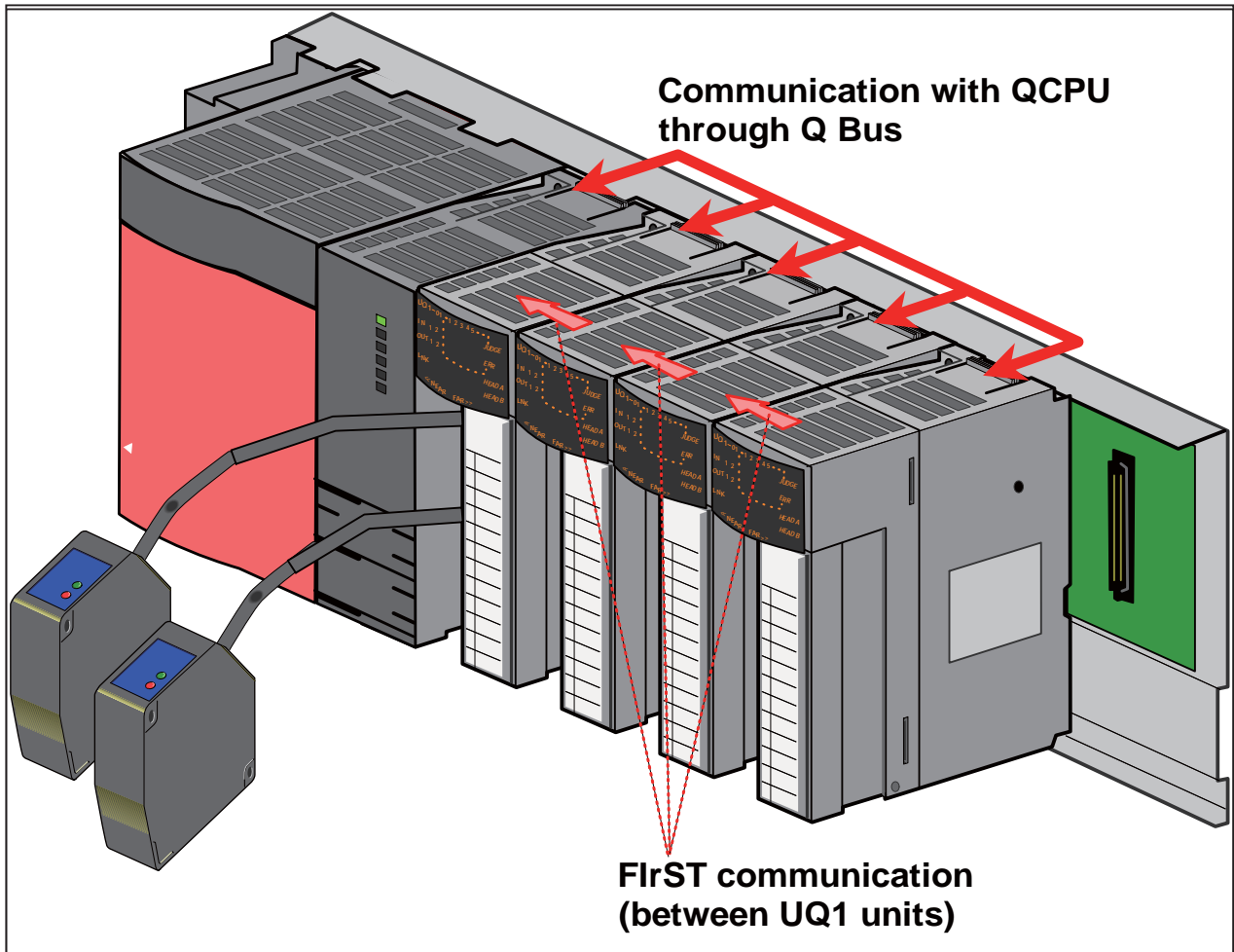

- You can connect up to 4 UQ1 series.
- You can connect up to 2 CD5 sensor heads to UQ1-01 unit.
- You can connect up to 2 CD33 sensor heads to UQ1-02 unit.
- UQ1 series utilize 2 ways of communication "Q Bus communication" and "FIRST communication".

2.1.1 FlrST communication

UQ1 units can communicate through “FlrST communication” utilizing infrared without using Q Bus.

● Advantages of “FlrST communication”

Advantages of “FlrST communication” are as follow.

<1> Fast communication

It works independently of the Q Bus so it can let UQ1 units communicate in 100μs in the shortest.

<2> Calculation using data from other QU1 unit

You can use measurement result from other UQ1 units installed next to the UQ1 unit (master side) for calculation. Up to 2 CD5/CD33 sensor heads can be connected to a unit and utilize more than 3 measurement result through “FlrST communication” for calculation for example getting average of them.

Tips

<1> “FlrST communication” is available only between adjacent UQ1 units.

UQ1 units must be installed at adjacent Bus.

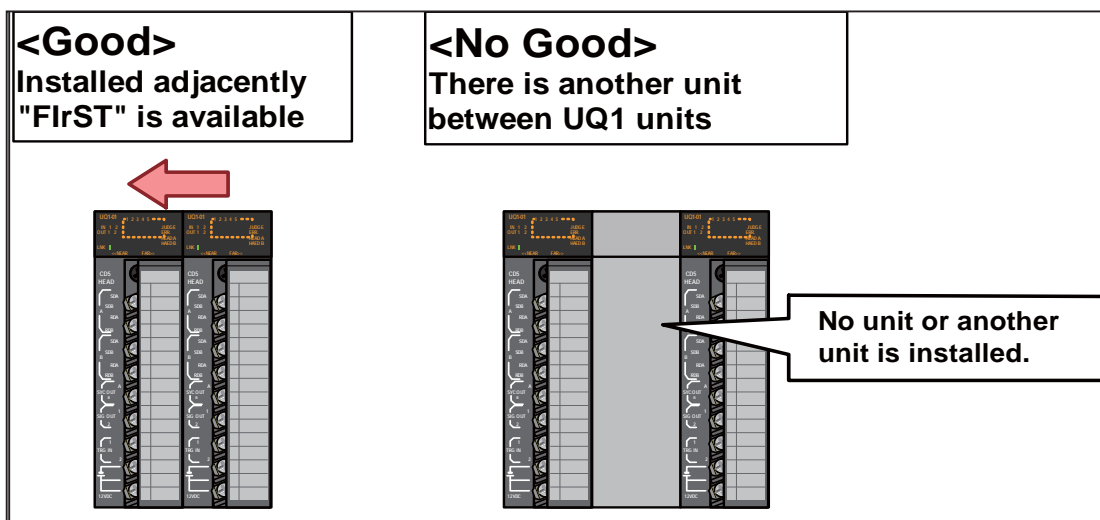

<2> Data is transferred only from slave side (far side from QCPU) to master side (near side of QCPU).

<3> Setup of data transmission is done at slave side.

Master side (near side of QCPU) unit treats the data as “Input data 1” and “Input data 2” because it doesn’t know transmission setup.

- “FlrST communication” is done every updating period.

- Up to 4 UQ1 units can be connected and data is transferred from the unit at far side to near side of QCPU one by one. Then, it delays for total cycle of updating period.





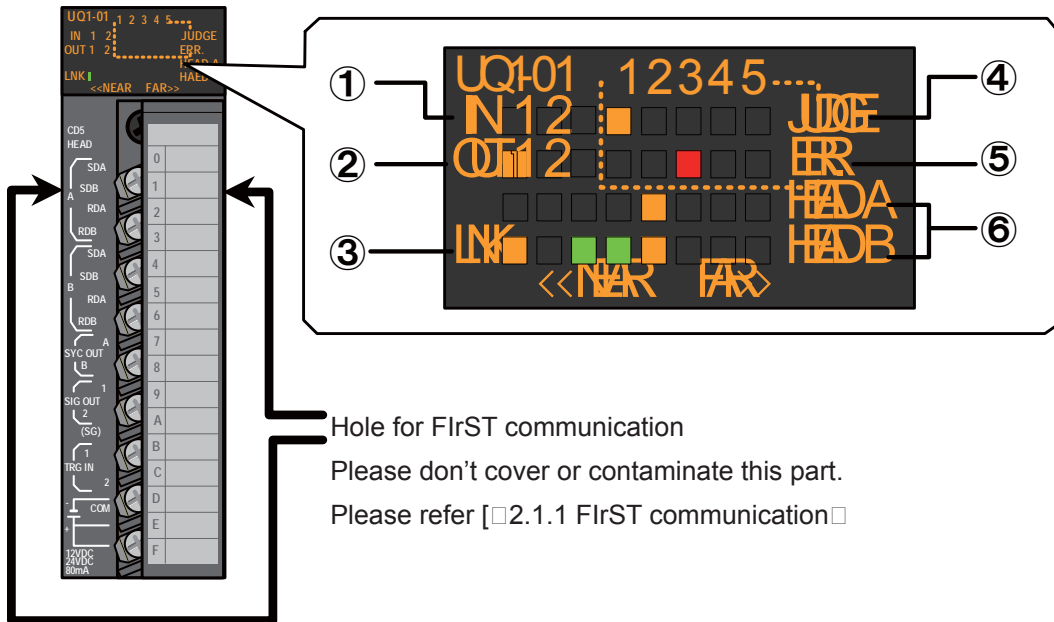

2.2 Display/Terminal/Wiring

2.2.1 Display / Terminal

● Display



No.	Item	Description	Note
1	IN1/2	Status of the terminal IN1/2	Orange when it's ON
2	OUT1/2	Status of the terminal OUT1/2	Orange when it's ON
3	LNK	Status of FIrST communication between the unit and next unit at slave side.	Orange when the communication is made
4	JUDGE	Status of the control output Q1~Q5.	Orange when the control output is ON (X0B ~ X0F = 0)
5	ERR	Error status of the control output Q1~Q5.	Red when it's error. You can release the error by re-booting the unit or setting Error release Y16 ON.

6	HEAD A/B	<p>Show distance that Head A and B are measuring. When the distance is out of range, all LEDs blink.</p>	<p><1> Measuring center ($\pm 10\%$) </p> <p><2> Measuring near side   LEDs ON depends on distance</p> <p><3> Out of range (blink) </p> <p><4> Laser is OFF (blink) </p> <p><5> Monitoring Wave - No light received (ON)  - LED at the position of light peak is OFF </p>
---	----------	--	---

Tips

- Please refer [5.1.1 Process] about other status.

● Terminal

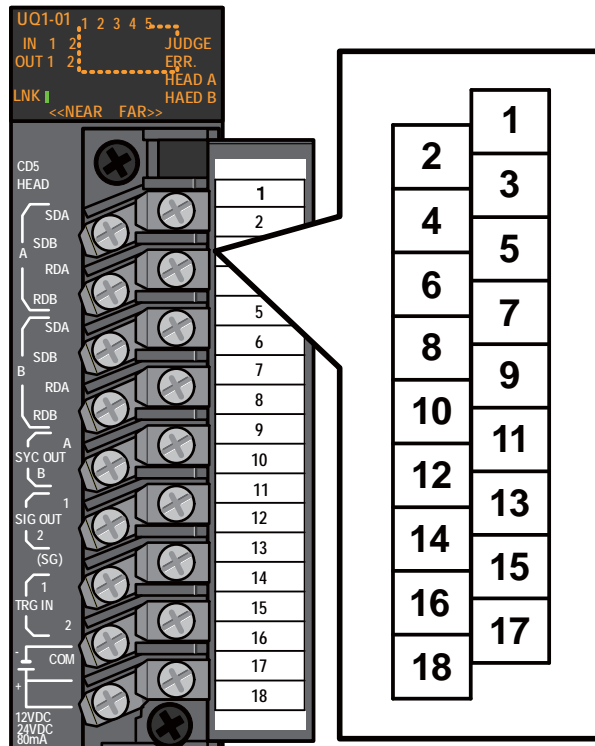

UQ1 Terminal block

No.	Terminal	Function	Note
1	[Head A] SDA	Head A send (+)	RS422 signals for Head A (GND to be connected to 13 SG.)
2	[Head A] SDB	Head A send (-)	
3	[Head A] RDA	Head A receive (+)	
4	[Head A] RDB	Head A receive (-)	
5	[Head B] SDA	Head B send (+)	RS422 signals for Head B (GND to be connected to 13 SG.)
6	[Head B] SDB	Head B send (-)	
7	[Head B] RDA	Head B receive (+)	
8	[Head B] RDB	Head B receive (-)	
9	Sync Out A	Head A Sync out	For preventing cross talk
10	Sync Out B	Head B Sync out	For preventing cross talk
11	Signal Out 1	Control out [1]	
12	Signal Out 2	Control out [2]	
13	SG	Signal Ground	GND of RS422 to be connected
14	Trigger In 1	Trigger in [1]	
15	Trigger In 2	Trigger in [2]	
16	COM(SG)	I/O common (-)	GND of [Sync Out], [Signal Out], [Trigger In] to be connected
17	12~24V	I/O power (+)	Plus line of DC12~24V power supply to be connected (No.17 and 18 is connected internally on PCB)
18	12~24V	I/O power (+)	

2.2.2 Wiring

Please read this chapter carefully before wiring.

Warning

Please confirm that the source of power supply is shut down before wiring to prevent electric shock and damage of the product.

Please confirm that the cover is fixed over terminal block after wiring and before power on to prevent electric shock.

Caution

To prevent malfunction and storing wrong data because of noise, please keep following.

- 1) Please confirm that communication lines are not banded with power line and high voltage line to prevent noise and surge induction.
 - 2) Please confirm that the grounding of the cable shield line is done at a ground point of sequencer side. Please don't connect the ground line of high power line at the same grounding point.
-

● Procedure

- Shut down the power supply of sequencer.
- Wire CD5 sensor to the unit (UQ1-01).
- Wire CD33 sensor to the unit (UQ1-02).

● Terminal block

- M3 screws are used for terminal block of UQ1 series.
Please use solder less terminal R1.25-3 (without sleeve).
Tightening torque : 0.5 ~ 0.8N·m

● Input / Output Schematic (CD5)

Schematic (Head A)

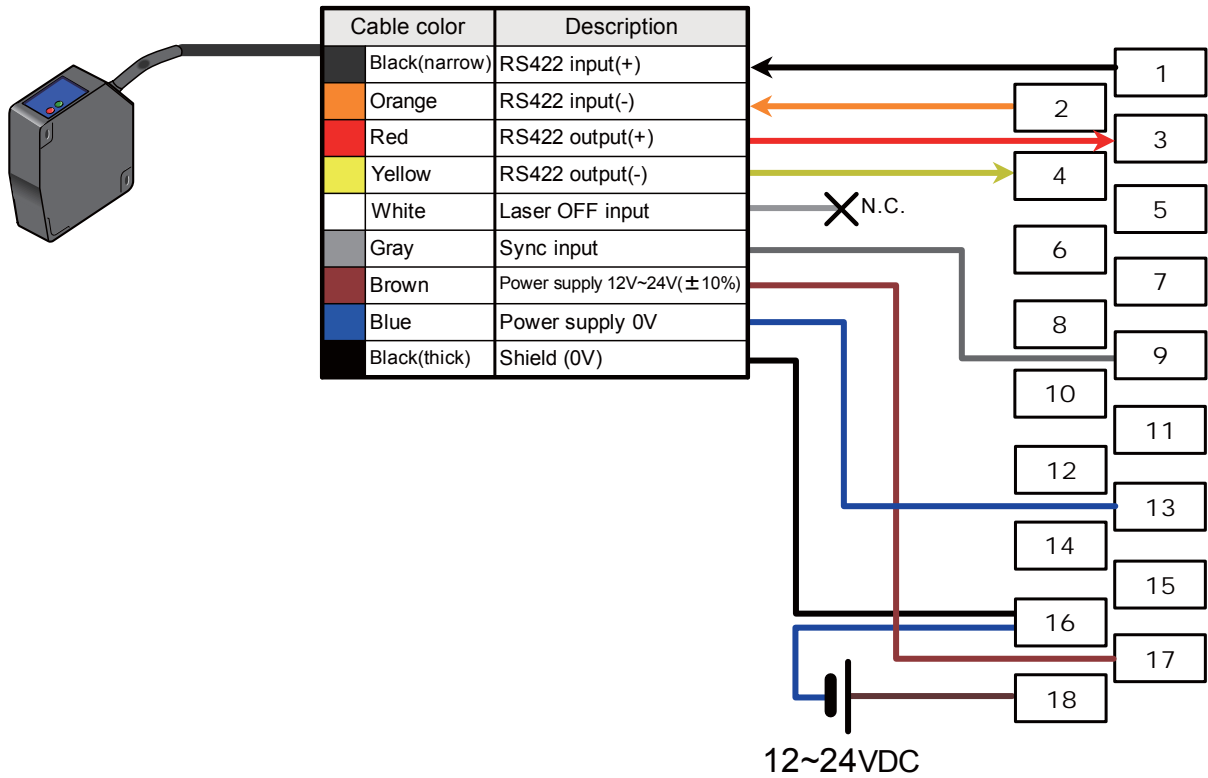

Schematic (Head B)

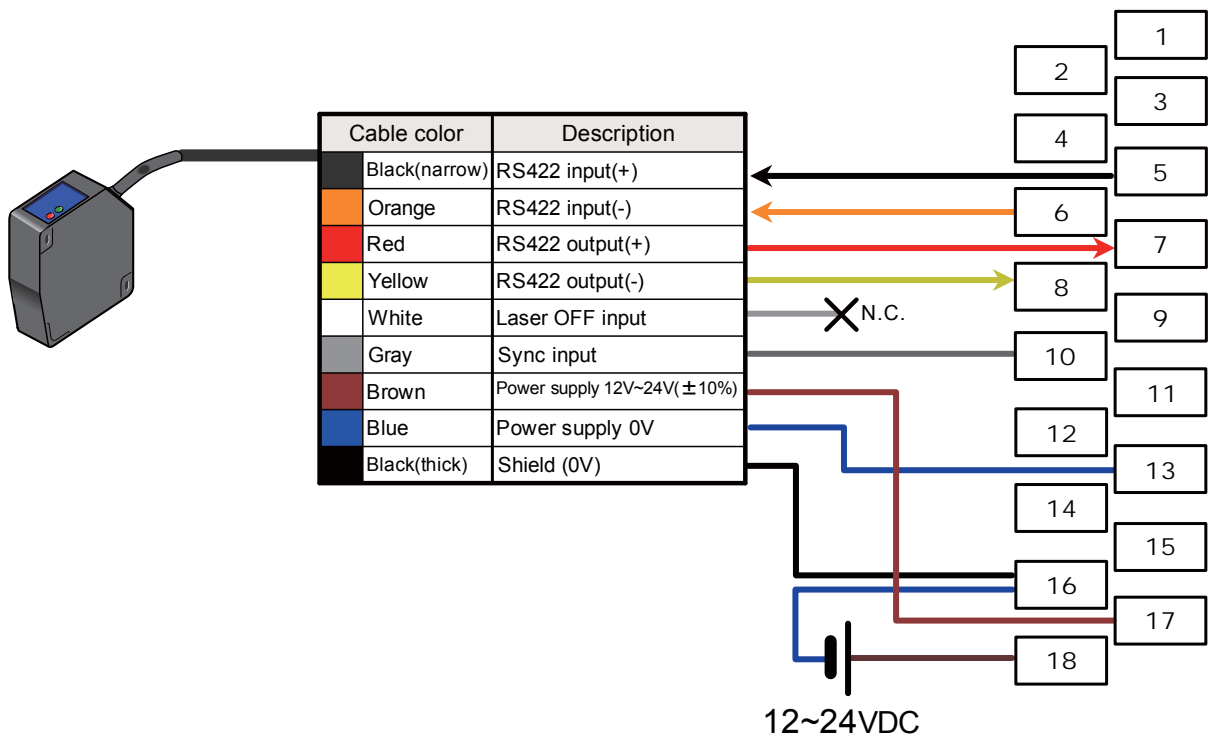

● Input / Output Schematic (CD33)

Schematic (Head A)

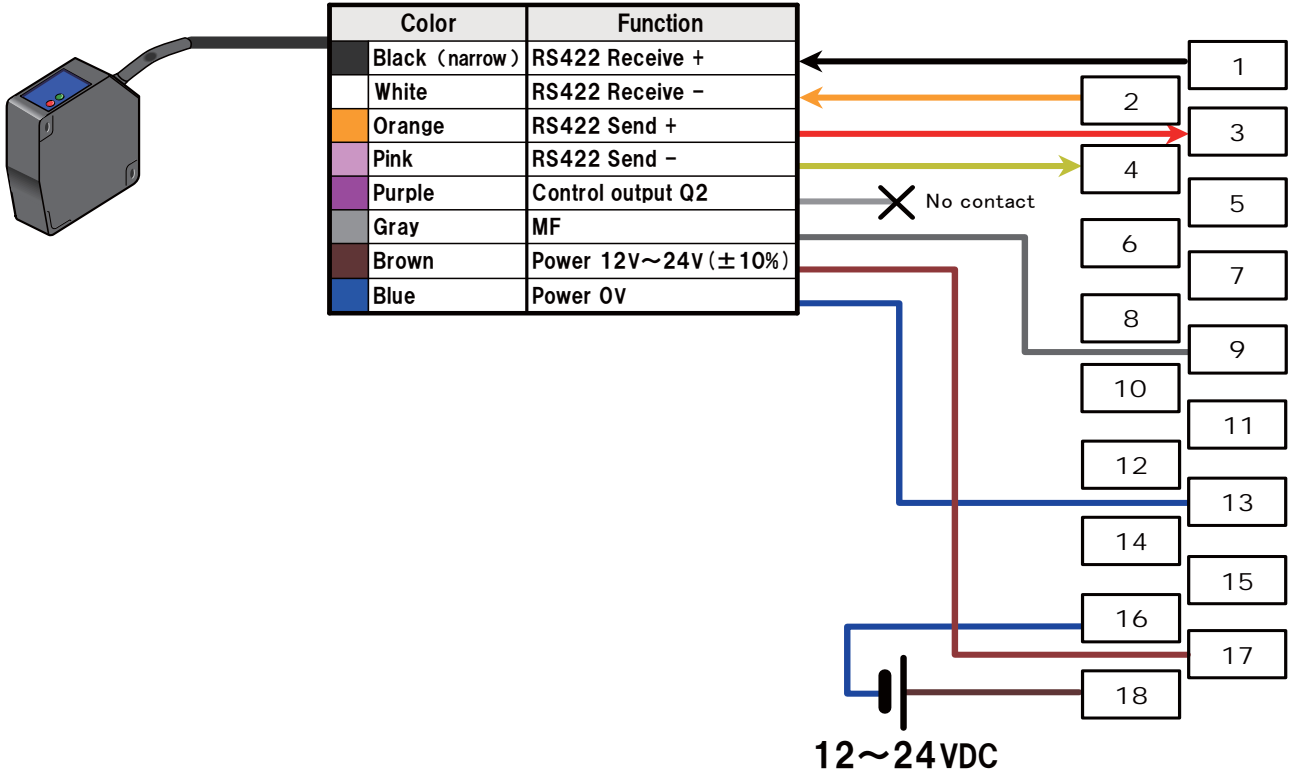

Schematic (Head B)

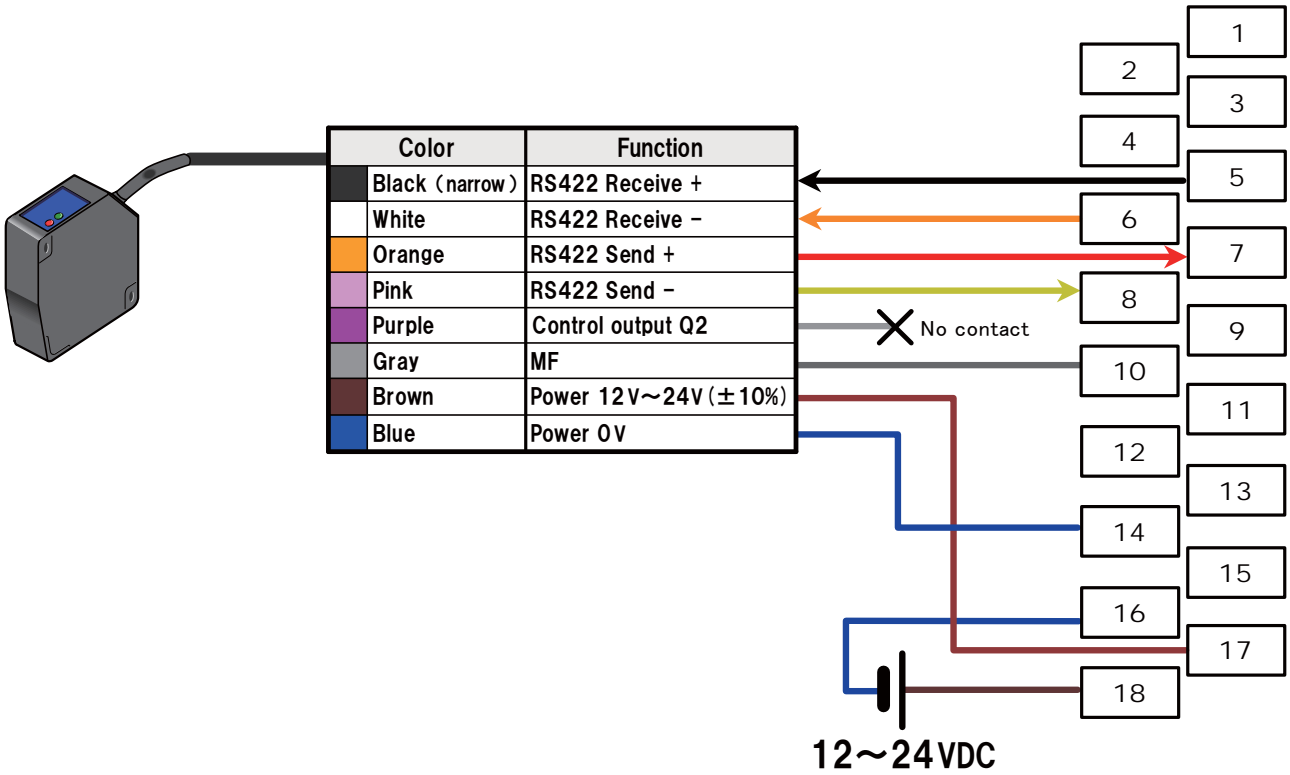

● Grounding

- Please ground UQ1 series as following.
- Ground each equipment individually as much as available.
- Grounding impedance should be less than 100Ω .
- If you couldn't ground equipment individually, please ground to common point.

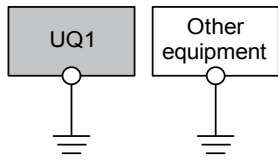

Individual grounding
(the best)

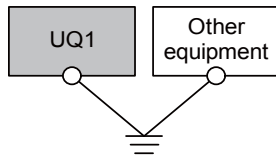

One point grounding
(OK)

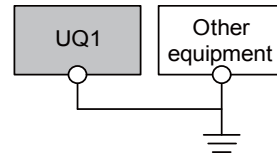

Just connecting to ground
(No good)

- Please use thicker than AWG14(2mm^2) for grounding line.
- Please shorten the grounding line as much as possible.

2.2.3 Input / Output schematic

● Input schematic

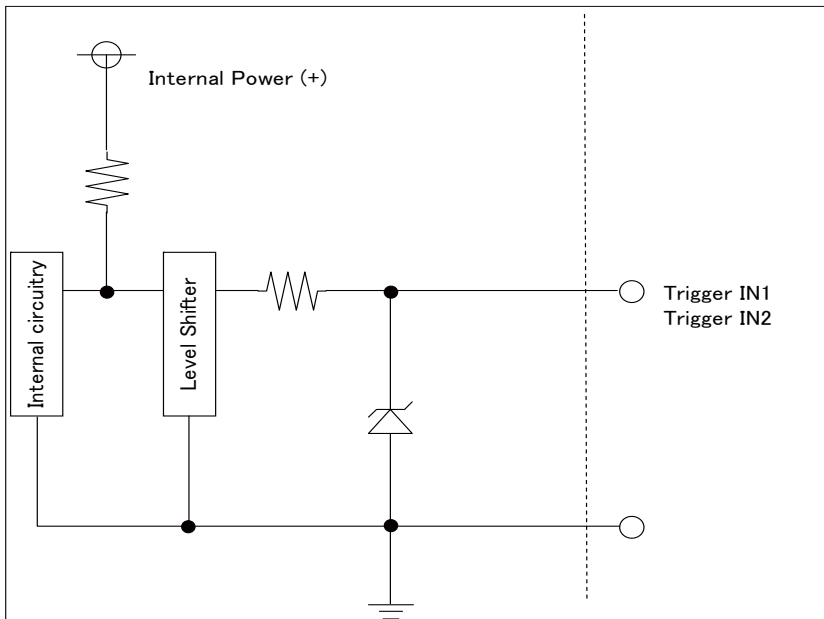

Tips

- Function of the input (Trigger IN1/2) is defined at shared memory address 116~118.
- Input level is fetched every updating period of UQ1 independent of sequencer scan timing.

● Output schematic

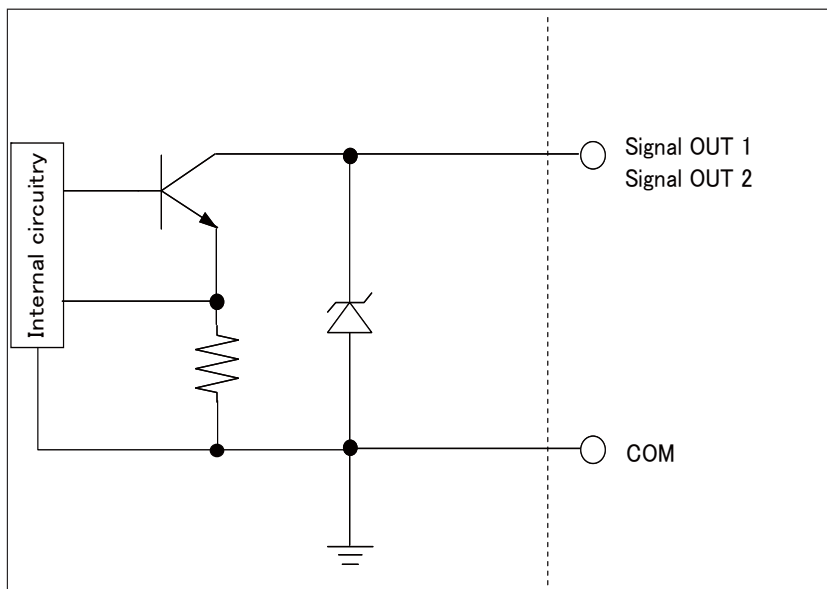

Tips

- Function of the out (Signal OUT1/2) is defined at shared memory 113~115.
- Output is updated every updating period of UQ1-01 independent of sequencer scan timing.

3

Function

3.1 Shared memory and X/Y device

UQ1 series X/Y device table and function are as follows. Please refer chapter 2 about outline.

3.1.1 X/Y device table

Address of X/Y device is described in hexadecimal.

X (Input)			Y (Output)			
decimal	hex.	description	decimal	hex.	Int.	description
X00	X00	Unit ready (reserved)	Y00	Y00	Yes	Zero reset Q1
X01	X01	Q1 Upper (0= below "upper", 1= "upper" and over)	Y01	Y01	Yes	Zero reset Q2
X02	X02	Q1 Lower (0= over "lower", 1= "lower" and under)	Y02	Y02	Yes	Zero reset Q3
X03	X03	Q2 Upper	Y03	Y03	Yes	Zero reset Q4
X04	X04	Q2 Lower	Y04	Y04	Yes	Zero reset Q5
X05	X05	Q3 Upper	Y05	Y05	Yes	
X06	X06	Q3 Lower	Y06	Y06	Yes	
X07	X07	Q4 Upper	Y07	Y07	Yes	
X08	X08	Q4 Lower	Y08	Y08		Switching Bank
X09	X09	Q5 Upper	Y09	Y09		RESET
X10	X0A	Q5 Lower	Y10	Y0A		Trigger IN A
X11	X0B	Q1 judge (1=OK)	Y11	Y0B		Trigger IN B
X12	X0C	Q2 judge (1=OK)	Y12	Y0C		Trigger IN Calculation 1
X13	X0D	Q3 judge (1=OK)	Y13	Y0D		Trigger IN Calculation 2
X14	X0E	Q4 judge (1=OK)	Y14	Y0E		Trigger IN Calculation 3
X15	X0F	Q5 judge (1=OK)	Y15	Y0F		Getting Data stored
X16	X10	BUSY: Over writing Common setup	Y16	Y10		Over writing common setup
X17	X11	BUSY: Over writing Bank setup	Y17	Y11		Over writing Bank setup
X18	X12	BUSY: Switching Bank setup	Y18	Y12		LASER OFF A (0=ON,1=OFF)
X19	X13	BUSY: Getting data stored	Y19	Y13		LASER OFF B (0=ON,1=OFF)
X20	X14	BUSY: Switching Head A monitoring mode	Y20	Y14		Head A Waveform mode *2
X21	X15	BUSY: Switching Head B monitoring mode	Y21	Y15		Head B Waveform mode *2
X22	X16	Head A out of range alarm	Y22	Y16		Error release
X23	X17	Head B out of range alarm	Y23	Y17		
X24	X18	Head A connection error *1	Y24	Y18		
X25	X19	Head B connection error *1	Y25	Y19		
X26	X1A	FlrST data error *1	Y26	Y1A		
X27	X1B	Q1 Error (no target sensor head) *1	Y27	Y1B		
X28	X1C	Q2 Error (no target sensor head) *1	Y28	Y1C		
X29	X1D	Q3 Error (no target sensor head) *1	Y29	Y1D		
X30	X1E	Q4 Error (no target sensor head) *1	Y30	Y1E		
X31	X1F	Q5 Error (no target sensor head) *1	Y31	Y1F		

*1 These errors can be released only by re-starting up the power supply or setting "Y16 error release" ON.

*2 Can be used only with specular type for UQ1-02.

3.1.2 Shared memory table

Address of the shared memory is described in decimal.

Shared memory in the address 0~30 are different between UQ1-01 and UQ1-02.

■ UQ1-01

Item	Address		Default	Parameters								
	Hex.	Decimal										
Sensor head A setup Over written by Y10=1	Measurement target	0000h	0	0	0=Surface	1=Flip side	2= Glass thickness		3= Glass gap			
	Diffuse / Specular	0001h	1	0	0=Diffuse	1=Specular						
	Laser power	0002h	2	5	0=OFF	1~5 (5:MAX.)						
	Sensitivity	0003h	3	11	0=Min.	1~10	11=AUTO					
	Threshold for detecting peak	0004h	4	0	0~14	15=AUTO						
	Shift	0005h	5	0	LOW	-50000000 b~ +50000000						
		0006h	6		HI	(Depends on the sensor head. Please refer [3.2.1 Sensor head setup])						
	Span	0007h	7	2710h (10000)	LOW	0 ~ 9C3Fh (0 ~ 39999) Example: 10000 means Span=1.0000						
		0008h	8		HI							
	Moving average number	0009h	9	8	0=1 time	1=2 times	2=4 times	3=8 times	4=16 times	5=32 times	6=64 times	7=128 times
					8=256 times	9=512 times	A=1024 times	B=2048 times	C=4096 times			
	Alarm processing	000Ah	10	0	0=Clamp	1=Hold						
	Sampling period	000Bh	11	0	0=100us	1=200us	2=400us	3=800us	4=1600us	5=3200us	6=AUTO	
	Reserved	000Ch	12									
Reserved	000Dh	13										
Sensor head B setup Over written by Y10=1	Measurement target	000Eh	14	0	0=Surface	1=Flip side	2= Glass thickness		3= Glass gap			
	Diffuse / Specular	000Fh	15	0	0=Diffuse	1=Specular						
	Laser power	0010h	16	5	0=OFF	1~5 (5:MAX.)						
	Sensitivity	0011h	17	11	0=Min.	1~10	11=AUTO					
	Threshold for detecting peak	0012h	18	0	0~14	15=AUTO						
	Shift	0013h	19	0	LOW	-50000000 b~ +50000000						
		0014h	20		HI	(Depends on the sensor head. Please refer [3.2.1 Sensor head setup])						
	Span	0015h	21	2710h (10000)	LOW	0 ~ 9C3Fh (0 ~ 39999) Example: 10000 means Span=1.0000						
		0016h	22		HI							
	Moving average number	0017h	23	8	0=1 time	1=2 times	2=4 times	3=8 times	4=16 times	5=32 times	6=64 times	7=128 times
					8=256 times	9=512 times	A=1024 times	B=2048 times	C=4096 times			
	Alarm processing	0018h	24	0	0=Clamp	1=Hold						
	Sampling period	0019h	25	0	0=100us	1=200us	2=400us	3=800us	4=1600us	5=3200us	6=AUTO	
	Reserved	001Ah	26									
Reserved	001Bh	27										
Sensor head A/B setup	Cross talk prevention function	001Ch	28	0	0=OFF	1=ON						
	filter choice	001Dh	29	0	0=OFF	1=High pass filter		1=Low pass filter				
	Cutoff frequency	001Eh	30	0	0=High	~ 7= Low						

■ UQ1-02

Item	Address		Default	Parameters							
	Hex.	Decimal									
Sensor head A setup Over written by Y10=1	Measurement target	0000h	0	0	0= Peak	1= Surface	2=Flip side	3= Glass thickness			
	Reserved	0001h	1								
	Laser	0002h	2	1	0=OFF	1=ON					
	Reserved	0003h	3								
	Reserved	0004h	4								
	Shift	0005h	5	0	LOW	-50000000 b~ +50000000					
		0006h	6		HI	(Depends on the sensor head. Please refer [3.2.1 Sensor head setup])					
	Span	0007h	7	2710h (10000)	LOW	0 ~ 9C3Fh (0 ~ 39999) Example: 10000 means Span=1.0000					
		0008h	8		HI						
	Moving average number	0009h	9	1	0= 1 time	1=16 times	2=64 times				
	Alarm processing	000Ah	10	0	0=Clamp	1=Hold					
	Sampling period	000Bh	11	0	0=500us (250mm type: 750us)				1=1000us	2=1500us	3=2000us
	Reserved	000Ch	12								
	Reserved	000Dh	13								
Sensor head B setup Over written by Y10=1	Measurement target	000Eh	14	0	0= Peak	1= Surface	2=Flip side	3= Glass thickness			
	Reserved	000Fh	15								
	Laser	0010h	16	1	0=OFF	1=ON					
	Reserved	0011h	17								
	Reserved	0012h	18								
	Shift	0013h	19	0	LOW	-50000000 b~ +50000000					
		0014h	20		HI	(Depends on the sensor head. Please refer [3.2.1 Sensor head setup])					
	Span	0015h	21	2710h (10000)	LOW	0 ~ 9C3Fh (0 ~ 39999) Example: 10000 means Span=1.0000					
		0016h	22		HI						
	Moving average number	0017h	23	1	0= 1 time	1=16 times	2=64 times				
	Alarm processing	0018h	24	0	0=Clamp	1=Hold					
	Sampling period	0019h	25	0	0=500us (250mm type: 750us)				1=1000us	2=1500us	3=2000us
	Reserved	001Ah	26								
	Reserved	001Bh	27								
Reserved	001Ch	28									
Reserved	001Dh	29									
Reserved	001Eh	30									

Shared memory and X/Y device

■ UQ1-01/02 common parameters

Item	Address		Default	Parameters								
	Hex	Dec.										
High speed mode	001Fh	31	0	0=OFF	1=ON	(It doesn't do averaging when this parameter is 1=ON. "Auto average" and "Average" in measured result will be "0".)						
Q1 Source	0020h	32	0	0=A	1=B	2= Formula 1	3= Formula 2	4= Formula 3	5= Receiving data 1	6= Receiving data 2	7= None	
Q1 Hold	0021h	33	0	0= None	1= Sample	2= Peak	3= Bottom	4= Peak to Peak	5= Average			
Q2 Source	0022h	34	1	0=A	1=B	2= Formula 1	3= Formula 2	4= Formula 3	5= Receiving data 1	6= Receiving data 2	7= None	
Q2 Hold	0023h	35	0	0= None	1= Sample	2= Peak	3= Bottom	4= Peak to Peak	5= Average			
Q3 Source	0024h	36	7	0=A	1=B	2= Formula 1	3= Formula 2	4= Formula 3	5= Receiving data 1	6= Receiving data 2	7= None	
Q3 Hold	0025h	37	0	0= None	1= Sample	2= Peak	3= Bottom	4= Peak to Peak	5= Average			
Q4 Source	0026h	38	7	0=A	1=B	2= Formula 1	3= Formula 2	4= Formula 3	5= Receiving data 1	6= Receiving data 2	7= None	
Q4 Hold	0027h	39	0	0= None	1= Sample	2= Peak	3= Bottom	4= Peak to Peak	5= Average			
Q5 Source	0028h	40	7	0=A	1=B	2= Formula 1	3= Formula 2	4= Formula 3	5= Receiving data 1	6= Receiving data 2	7= None	
Q5 Hold	0029h	41	0	0= None	1= Sample	2= Peak	3= Bottom	4= Peak to Peak	5= Average			
Formula source 1-1	002Ah	42	0	0= None	1=A	2=B	3= Receiving data 1	4= Receiving data 2	5= Fixed value 1-1			
Formula source 1-2	002Bh	43	0	0= None	1=A	2=B	3= Receiving data 1	4= Receiving data 2	5= Fixed value 1-2			
Formula source 1-3	002Ch	44	0	0= None	1=A	2=B	3= Receiving data 1	4= Receiving data 2	5= Fixed value 1-3			
Formula source 1-4	002Dh	45	0	0= None	1=A	2=B	3= Receiving data 1	4= Receiving data 2	5= Fixed value 1-4			
Formula source 1-5	002Eh	46	0	0= None	1=A	2=B	3= Receiving data 1	4= Receiving data 2	5= Fixed value 1-5			
Reserved	002Fh	47										
Fixed value for Formula source 1-1	0030h 0031h	48 49	0	LOW HI	08000000 h (-2147483648) ~ 7FFFFFFFh (2147483647)							
Fixed value for Formula source 1-2	0032h 0033h	50 51	0	LOW HI	08000000 h (-2147483648) ~ 7FFFFFFFh (2147483647)							
Fixed value for Formula source 1-3	0034h 0035h	52 53	0	LOW HI	08000000 h (-2147483648) ~ 7FFFFFFFh (2147483647)							
Fixed value for Formula source 1-4	0036h 0037h	54 55	0	LOW HI	08000000 h (-2147483648) ~ 7FFFFFFFh (2147483647)							
Fixed value for Formula source 1-5	0038h 0039h	56 57	0	LOW HI	08000000 h (-2147483648) ~ 7FFFFFFFh (2147483647)							
Operator 1-1	003Ah	58	0	0= +	1= -	2= *	3= +					
Operator 1-2	003Bh	59	0	0= +	1= -	2= *	3= +					
Operator 1-3	003Ch	60	0	0= +	1= -	2= *	3= +					
Operator 1-4	003Dh	61	0	0= +	1= -	2= *	3= +					
Formula source 2-1	003Eh	62	0	0= None	1=A	2=B	3= Receiving data 1	4= Receiving data 2	5= Fixed value 2-1			
Formula source 2-2	003Fh	63	0	0= None	1=A	2=B	3= Receiving data 1	4= Receiving data 2	5= Fixed value 2-2			
Formula source 2-3	0040h	64	0	0= None	1=A	2=B	3= Receiving data 1	4= Receiving data 2	5= Fixed value 2-3			
Formula source 2-4	0041h	65	0	0= None	1=A	2=B	3= Receiving data 1	4= Receiving data 2	5= Fixed value 2-4			
Formula source 2-5	0042h	66	0	0= None	1=A	2=B	3= Receiving data 1	4= Receiving data 2	5= Fixed value 2-5			
Reserved	0043h	67										
Fixed value for Formula source 2-1	0044h 0045h	68 69	0	LOW HI	08000000 h (-2147483648) ~ 7FFFFFFFh (2147483647)							
Fixed value for Formula source 2-2	0046h 0047h	70 71	0	LOW HI	08000000 h (-2147483648) ~ 7FFFFFFFh (2147483647)							
Fixed value for Formula source 2-3	0048h 0049h	72 73	0	LOW HI	08000000 h (-2147483648) ~ 7FFFFFFFh (2147483647)							
Fixed value for Formula source 2-4	004Ah 004Bh	74 75	0	LOW HI	08000000 h (-2147483648) ~ 7FFFFFFFh (2147483647)							
Fixed value for Formula source 2-5	004Ch 004Dh	76 77	0	LOW HI	08000000 h (-2147483648) ~ 7FFFFFFFh (2147483647)							
Operator 2-1	004Eh	78	0	0= +	1= -	2= *	3= +					
Operator 2-2	004Fh	79	0	0= +	1= -	2= *	3= +					
Operator 2-3	0050h	80	0	0= +	1= -	2= *	3= +					
Operator 2-4	0051h	81	0	0= +	1= -	2= *	3= +					

UQ1 setup
Over written
by Y10=1

Q1-Q5 setup

Item	Address		Default	Parameters											
	Hex.	Dec.													
Q1~Q5 / Calculation setup	Formula source 3-1	0052h	82	0	0= None	1=A	2=B	3= Receiving data 1	4= Receiving data 2	5= Fixed value 3-1					
	Formula source 3-2	0053h	83	0	0= None	1=A	2=B	3= Receiving data 1	4= Receiving data 2	5= Fixed value 3-2					
	Formula source 3-3	0054h	84	0	0= None	1=A	2=B	3= Receiving data 1	4= Receiving data 2	5= Fixed value 3-3					
	Formula source 3-4	0055h	85	0	0= None	1=A	2=B	3= Receiving data 1	4= Receiving data 2	5= Fixed value 3-4					
	Formula source 3-5	0056h	86	0	0= None	1=A	2=B	3= Receiving data 1	4= Receiving data 2	5= Fixed value 3-5					
	Reserved	0057h	87												
	Fixed value for Formula source 3-1	0058h	88	0	LOW	080000000 h (-2147483648) ~ 7FFFFFFFh (2147483647)									
		0059h	89		HI										
	Fixed value for Formula source 3-2	005Ah	90	0	LOW	080000000 h (-2147483648) ~ 7FFFFFFFh (2147483647)									
		005Bh	91		HI										
	Fixed value for Formula source 3-3	005Ch	92	0	LOW	080000000 h (-2147483648) ~ 7FFFFFFFh (2147483647)									
		005Dh	93		HI										
	Fixed value for Formula source 3-4	005Eh	94	0	LOW	080000000 h (-2147483648) ~ 7FFFFFFFh (2147483647)									
		005Fh	95		HI										
	Fixed value for Formula source 3-5	0060h	96	0	LOW	080000000 h (-2147483648) ~ 7FFFFFFFh (2147483647)									
	0061h	97		HI											
Operator 3-1	0062h	98	0	0= +	1= -	2= *	3= +								
Operator 3-2	0063h	99	0	0= +	1= -	2= *	3= +								
Operator 3-3	0064h	100	0	0= +	1= -	2= *	3= +								
Operator 3-4	0065h	101	0	0= +	1= -	2= *	3= +								
Bank number	0066h	102	0	0 ~ 59 = Bank 0 ~ 59											
Hold mode	0067h	103	0	0 = Auto (data clear when RESET)			1 = Normal (data clear when sampling starts)								
Hysteresis	0068h	104	0	LOW	0 ~ 7FFFFFFFh (2147483647)										
	0069h	105		HI											
Output setup	ON delay	006Ah	106	0	0= None	1 ~ 0FFFFh (65535) ms			* Reflect to Signal Out 1, 2, X device						
	OFF delay	006Bh	107	0	0= None	1 ~ 0FFFFh (65535) ms			* Reflect to Signal Out 1, 2, X device						
	One shot	006Ch	108	0	0=OFF	1=ON	* Reflect to Signal Out 1, 2, X device								
	FIRST Transmit data 1 setup	006Dh	109	0	0= Head A	1= Head B	2=Formula 1	3=Formula 2	4=Formula 3	5= None					
	FIRST Transmit data 1 Hold	006Eh	110	0	0= None	1=Sample	2= Peak	3= Bottom	4= Peak to Peak	5=Average					
	FIRST Transmit data 2 setup	006Fh	111	1	0= Head A	1= Head B	2=Formula 1	3=Formula 2	4=Formula 3	5= None					
	FIRST Transmit data 2 Hold	0070h	112	0	0= None	1=Sample	2= Peak	3= Bottom	4= Peak to Peak	5=Average					
	Signal Out 1	0071h	113	0	0=Q1	1=Q2	2=Q3	3=Q4	4=Q5	* ON when out side of threshold					
Signal Out 2	0072h	114	1	0=Q1	1=Q2	2=Q3	3=Q4	4=Q5	* ON when out side of threshold						
Signal Out logic	0073h	115	0	0= All normal	1=1 is reverse	2=2 is reverse	3= All reverse								
Input setup	Trigger timing of data sampling	0074h	116	0	0= OFF	1= ON	2= Up edge		3= Down edge		* RESET effects at up edge only				
	Trigger IN 1	0075h	117	0	0= RESET	1= Head A	2= Head B	3=Formula 1	4=Formula 2	5=Formula 3					
	Trigger IN 2	0076h	118	1	0= RESET	1= Head A	2= Head B	3=Formula 1	4=Formula 2	5=Formula 3					
Data storing	Data store skip number	0077h	119	0	0=No skip	1 ~ 0FFFFh (65535)									
	Source of data	0078h	120	0	0=Q1	1=Q2	2=Q3	3=Q4	4=Q5	5=Head A	6=Head B	7=Formula 1			
						8= Formula 2	9= Formula 3		* Q1~Q5 will be added its offset.						
	Hold mode	0079h	121	0	0= None	1= Sample	2= Peak	3=Bottom	4= Peak to Peak	5=Average	* Effective when the source of data is Head A ~ Formula 3 (5~9)				
	Pointer clear timing	007Ah	122	1	0=When Trigger is ON		1=When RESET is ON								
	Pointer end control	007Bh	123	1	0=Stop	1=Continue from start									
Storage transfer start pointer	007Ch	124	0	LOW	Start pointer number (0 ~ 245928) of the internal storage memory for transferring to shared memory. 262144 (14Eh~7FDh) totally (every 16216). This is effective immediately after updating.										
	007Dh	125		HI											
Reserved	007Eh	126	0												
Initialize	Initialize	007Fh	127	0101h	* Initialize by rebooting after setting this parameter "0" and Y10 as "1".										

■ Measurement result

Item	Address		Default	Parameters					
	Hex.	Dec.		LOW	HI				
Bank setup Over written by Y11=1	Threshold / Offset	Q1 Upper threshold	0080h 128 0081h 129	47868C0h (75000000)	LOW HI	08000000h (-2147483648) ~ 7FFFFFFFh (2147483647)	(Offset is reflected)		
		Q1 Lower threshold	0082h 130 0083h 131	0FB879740h (-75000000)	LOW HI	08000000h (-2147483648) ~ 7FFFFFFFh (2147483647)	(Offset is reflected)		
		Q2 Upper threshold	0084h 132 0085h 133	47868C0h (75000000)	LOW HI	08000000h (-2147483648) ~ 7FFFFFFFh (2147483647)	(Offset is reflected)		
		Q2 Lower threshold	0086h 134 0087h 135	0FB879740h (-75000000)	LOW HI	08000000h (-2147483648) ~ 7FFFFFFFh (2147483647)	(Offset is reflected)		
		Q3 Upper threshold	0088h 136 0089h 137	47868C0h (75000000)	LOW HI	08000000h (-2147483648) ~ 7FFFFFFFh (2147483647)	(Offset is reflected)		
		Q3 Lower threshold	008Ah 138 008Bh 139	0FB879740h (-75000000)	LOW HI	08000000h (-2147483648) ~ 7FFFFFFFh (2147483647)	(Offset is reflected)		
		Q4 Upper threshold	008Ch 140 008Dh 141	47868C0h (75000000)	LOW HI	08000000h (-2147483648) ~ 7FFFFFFFh (2147483647)	(Offset is reflected)		
		Q4 Lower threshold	008Eh 142 008Fh 143	0FB879740h (-75000000)	LOW HI	08000000h (-2147483648) ~ 7FFFFFFFh (2147483647)	(Offset is reflected)		
		Q5 Upper threshold	0090h 144 0091h 145	47868C0h (75000000)	LOW HI	08000000h (-2147483648) ~ 7FFFFFFFh (2147483647)	(Offset is reflected)		
		Q5 Lower threshold	0092h 146 0093h 147	0FB879740h (-75000000)	LOW HI	08000000h (-2147483648) ~ 7FFFFFFFh (2147483647)	(Offset is reflected)		
		Q1 Offset	0094h 148 0095h 149	0	LOW HI	08000000h (-2147483648) ~ 7FFFFFFFh (2147483647)			
		Q2 Offset	0096h 150 0097h 151	0	LOW HI	08000000h (-2147483648) ~ 7FFFFFFFh (2147483647)			
		Q3 Offset	0098h 152 0099h 153	0	LOW HI	08000000h (-2147483648) ~ 7FFFFFFFh (2147483647)			
		Q4 Offset	009Ah 154 009Bh 155	0	LOW HI	08000000h (-2147483648) ~ 7FFFFFFFh (2147483647)			
		Q5 Offset	009Ch 156 009Dh 157	0	LOW HI	08000000h (-2147483648) ~ 7FFFFFFFh (2147483647)			
		Reserved	009Eh 158						
		Reserved	009Fh 159						
		Result	Q1~Q5 result	Q1	00A0h 160 00A1h 161		LOW HI	08000000h (-2147483648) ~ 7FFFFFFFh (2147483647)	(Offset is reflected)
				Q2	00A2h 162 00A3h 163		LOW HI	08000000h (-2147483648) ~ 7FFFFFFFh (2147483647)	(Offset is reflected)
				Q3	00A4h 164 00A5h 165		LOW HI	08000000h (-2147483648) ~ 7FFFFFFFh (2147483647)	(Offset is reflected)
Q4	00A6h 166 00A7h 167				LOW HI	08000000h (-2147483648) ~ 7FFFFFFFh (2147483647)	(Offset is reflected)		
Q5	00A8h 168 00A9h 169				LOW HI	08000000h (-2147483648) ~ 7FFFFFFFh (2147483647)	(Offset is reflected)		
Center stand off	Head A Center stand off		00AAh 170 00ABh 171	Fixed value by type	LOW HI	2500000(25mm) ~ 20000000 (2000mm)			
	Head B Center stand off		00ACh 172 00ADh 173	Fixed value by type	LOW HI	2500000(25mm) ~ 20000000 (2000mm)			
	Reserved		00AEh 174						
	Reserved		00AFh 175						
Measurement result	Head A		00B0h 176 00B1h 177		LOW HI	08000000h (-2147483648) ~ 7FFFFFFFh (2147483647)			
	Head A Sample Hold		00B2h 178 00B3h 179		LOW HI	08000000h (-2147483648) ~ 7FFFFFFFh (2147483647)	set by "Pointer clear timing"		
	Head A Auto Peak Hold		00B4h 180 00B5h 181		LOW HI	08000000h (-2147483648) ~ 7FFFFFFFh (2147483647)	set by "Pointer clear timing"		
	Head A Peak Hold		00B6h 182 00B7h 183		LOW HI	08000000h (-2147483648) ~ 7FFFFFFFh (2147483647)	set by "Pointer clear timing"		
	Head A auto Bottom Hold		00B8h 184 00B9h 185		LOW HI	08000000h (-2147483648) ~ 7FFFFFFFh (2147483647)	set by "Pointer clear timing"		
	Head A Bottom Hold		00BAh 186 00BBh 187		LOW HI	08000000h (-2147483648) ~ 7FFFFFFFh (2147483647)	set by "Pointer clear timing"		
	Head A Auto Peak to Peak Hold		00BCh 188 00BDh 189		LOW HI	0 ~ 7FFFFFFFh (2147483647)	set by "Pointer clear timing"		
	Head A Peak to Peak Hold		00BEh 190 00BFh 191		LOW HI	0 ~ 7FFFFFFFh (2147483647)	set by "Pointer clear timing"		

Item	Address		Default	Parameters	
	Hex	Dec.			
Result	Measurement result	Head A Auto Average Hold	00C0h 192 00C1h 193	LOW HI	08000000h (-2147483648) ~ 7FFFFFFFh (2147483647) set by "Pointer clear timing"
		Head A Average Hold	00C2h 194 00C3h 195	LOW HI	08000000h (-2147483648) ~ 7FFFFFFFh (2147483647) set by "Pointer clear timing"
		Head A Count	00C4h 196 00C5h 197	LOW HI	08000000h (-2147483648) ~ 7FFFFFFFh (2147483647) set by "Pointer clear timing"
		Head B	00C6h 198 00C7h 199	LOW HI	08000000h (-2147483648) ~ 7FFFFFFFh (2147483647)
		Head B Sample Hold	00C8h 200 00C9h 201	LOW HI	08000000h (-2147483648) ~ 7FFFFFFFh (2147483647) set by "Pointer clear timing"
		Head B Auto Peak Hold	00CAh 202 00CBh 203	LOW HI	08000000h (-2147483648) ~ 7FFFFFFFh (2147483647) set by "Pointer clear timing"
		Head B Peak Hold	00CCh 204 00CDh 205	LOW HI	08000000h (-2147483648) ~ 7FFFFFFFh (2147483647) set by "Pointer clear timing"
		Head B auto Bottom Hold	00CEh 206 00CFh 207	LOW HI	08000000h (-2147483648) ~ 7FFFFFFFh (2147483647) set by "Pointer clear timing"
		Head B Bottom Hold	00D0h 208 00D1h 209	LOW HI	08000000h (-2147483648) ~ 7FFFFFFFh (2147483647) set by "Pointer clear timing"
		Head B Auto Peak to Peak Hold	00D2h 210 00D3h 211	LOW HI	0 ~ 7FFFFFFFh (2147483647) set by "Pointer clear timing"
		Head B Peak to Peak Hold	00D4h 212 00D5h 213	LOW HI	0 ~ 7FFFFFFFh (2147483647) set by "Pointer clear timing"
		Head B Auto Average Hold	00D6h 214 00D7h 215	LOW HI	08000000h (-2147483648) ~ 7FFFFFFFh (2147483647) set by "Pointer clear timing"
		Head B Average Hold	00D8h 216 00D9h 217	LOW HI	08000000h (-2147483648) ~ 7FFFFFFFh (2147483647) set by "Pointer clear timing"
		Head B Count	00DAh 218 00DBh 219	LOW HI	08000000h (-2147483648) ~ 7FFFFFFFh (2147483647) set by "Pointer clear timing"
		Formula 1	00DCh 220 00DDh 221	LOW HI	08000000h (-2147483648) ~ 7FFFFFFFh (2147483647)
		Formula 1 Sample Hold	00DEh 222 00DFh 223	LOW HI	08000000h (-2147483648) ~ 7FFFFFFFh (2147483647) set by "Pointer clear timing"
		Formula 1 Auto Peak Hold	00E0h 224 00E1h 225	LOW HI	08000000h (-2147483648) ~ 7FFFFFFFh (2147483647) set by "Pointer clear timing"
		Formula 1 Peak Hold	00E2h 226 00E3h 227	LOW HI	08000000h (-2147483648) ~ 7FFFFFFFh (2147483647) set by "Pointer clear timing"
		Formula 1 Auto Bottom Hold	00E4h 228 00E5h 229	LOW HI	08000000h (-2147483648) ~ 7FFFFFFFh (2147483647) set by "Pointer clear timing"
		Formula 1 Bottom Hold	00E6h 230 00E7h 231	LOW HI	08000000h (-2147483648) ~ 7FFFFFFFh (2147483647) set by "Pointer clear timing"
		Formula 1 Auto Peak to Peak Hold	00E8h 232 00E9h 233	LOW HI	0 ~ 7FFFFFFFh (2147483647) set by "Pointer clear timing"
		Formula 1 Peak to Peak Hold	00EAh 234 00EBh 235	LOW HI	0 ~ 7FFFFFFFh (2147483647) set by "Pointer clear timing"
		Formula 1 Auto Average Hold	00ECh 236 00EDh 237	LOW HI	08000000h (-2147483648) ~ 7FFFFFFFh (2147483647) set by "Pointer clear timing"
		Formula 1 Average Hold	00EEh 238 00EFh 239	LOW HI	08000000h (-2147483648) ~ 7FFFFFFFh (2147483647) set by "Pointer clear timing"
		Formula 1 Count	00F0h 240 00F1h 241	LOW HI	08000000h (-2147483648) ~ 7FFFFFFFh (2147483647) set by "Pointer clear timing"
		Formula 2	00F2h 242 00F3h 243	LOW HI	08000000h (-2147483648) ~ 7FFFFFFFh (2147483647)
		Formula 2 Sample Hold	00F4h 244 00F5h 245	LOW HI	08000000h (-2147483648) ~ 7FFFFFFFh (2147483647) set by "Pointer clear timing"
		Formula 2 Auto Peak Hold	00F6h 246 00F7h 247	LOW HI	08000000h (-2147483648) ~ 7FFFFFFFh (2147483647) set by "Pointer clear timing"
		Formula 2 Peak Hold	00F8h 248 00F9h 249	LOW HI	08000000h (-2147483648) ~ 7FFFFFFFh (2147483647) set by "Pointer clear timing"
		Formula 2 Auto Bottom Hold	00FAh 250 00FBh 251	LOW HI	08000000h (-2147483648) ~ 7FFFFFFFh (2147483647) set by "Pointer clear timing"
		Formula 2 Bottom Hold	00FCh 252 00FDh 253	LOW HI	08000000h (-2147483648) ~ 7FFFFFFFh (2147483647) set by "Pointer clear timing"
		Formula 2 Auto Peak to Peak Hold	00FEh 254 00FFh 255	LOW HI	0 ~ 7FFFFFFFh (2147483647) set by "Pointer clear timing"
		Formula 2 Peak to Peak Hold	0100h 256 0101h 257	LOW HI	0 ~ 7FFFFFFFh (2147483647) set by "Pointer clear timing"
		Formula 2 Auto Average Hold	0102h 258 0103h 259	LOW HI	08000000h (-2147483648) ~ 7FFFFFFFh (2147483647) set by "Pointer clear timing"
		Formula 2 Average Hold	0104h 260 0105h 261	LOW HI	08000000h (-2147483648) ~ 7FFFFFFFh (2147483647) set by "Pointer clear timing"
		Formula 2 Count	0106h 262 0107h 263	LOW HI	08000000h (-2147483648) ~ 7FFFFFFFh (2147483647) set by "Pointer clear timing"
		Formula 3	0108h 264 0109h 265	LOW HI	08000000h (-2147483648) ~ 7FFFFFFFh (2147483647)
		Formula 3 Sample Hold	010Ah 266 010Bh 267	LOW HI	08000000h (-2147483648) ~ 7FFFFFFFh (2147483647) set by "Pointer clear timing"
		Formula 3 Auto Peak Hold	010Ch 268 010Dh 269	LOW HI	08000000h (-2147483648) ~ 7FFFFFFFh (2147483647) set by "Pointer clear timing"
		Formula 3 Peak Hold	010Eh 270 010Fh 271	LOW HI	08000000h (-2147483648) ~ 7FFFFFFFh (2147483647) set by "Pointer clear timing"

Shared memory and X/Y device

Item	Address		Default	Parameters										
	Hex.	Dec.												
Result	Measurement result	Formula 3 Auto Bottom Hold	0110h	272		LOW	08000000h (-2147483648) ~ 7FFFFFFFh (2147483647)							
			0111h	273		HI	set by "Pointer clear timing"							
		Formula 3 Bottom Hold	0112h	274		LOW	08000000h (-2147483648) ~ 7FFFFFFFh (2147483647)							
			0113h	275		HI	set by "Pointer clear timing"							
		Formula 3 Auto Peak to Peak Hold	0114h	276		LOW	0 ~ 7FFFFFFFh (2147483647)							
			0115h	277		HI	set by "Pointer clear timing"							
		Formula 3 Peak to Peak Hold	0116h	278		LOW	0 ~ 7FFFFFFFh (2147483647)							
			0117h	279		HI	set by "Pointer clear timing"							
		Formula 3 Auto Average Hold	0118h	280		LOW	08000000h (-2147483648) ~ 7FFFFFFFh (2147483647)							
			0119h	281		HI	set by "Pointer clear timing"							
		Formula 3 Average Hold	011Ah	282		LOW	08000000h (-2147483648) ~ 7FFFFFFFh (2147483647)							
			011Bh	283		HI	set by "Pointer clear timing"							
		Formula 3 Count	011Ch	284		LOW	08000000h (-2147483648) ~ 7FFFFFFFh (2147483647)							
			011Dh	285		HI	set by "Pointer clear timing"							
		Receiving data 1	011Eh	286		LOW	08000000h (-2147483648) ~ 7FFFFFFFh (2147483647)							
		011Fh	287		HI									
	Receiving data 2	0120h	288		LOW	08000000h (-2147483648) ~ 7FFFFFFFh (2147483647)								
		0121h	289		HI									
	Reserved	0122h	290											
	Reserved	0123h	291											
	Reserved	0124h	292											
	Reserved	0125h	293											
	Reserved	0126h	294											
	Reserved	0127h	295											
	Element of Formula	Element 1 of Formula 1	0128h	296		LOW	08000000h (-2147483648) ~ 7FFFFFFFh (2147483647)							
			0129h	297		HI								
		Element 2 of Formula 1	012Ah	298		LOW	08000000h (-2147483648) ~ 7FFFFFFFh (2147483647)							
			012Bh	299		HI								
		Element 3 of Formula 1	012Ch	300		LOW	08000000h (-2147483648) ~ 7FFFFFFFh (2147483647)							
			012Dh	301		HI								
Element 1 of Formula 2		012Eh	302		LOW	08000000h (-2147483648) ~ 7FFFFFFFh (2147483647)								
		012Fh	303		HI									
Element 2 of Formula 2		0130h	304		LOW	08000000h (-2147483648) ~ 7FFFFFFFh (2147483647)								
		0131h	305		HI									
Element 3 of Formula 2		0132h	306		LOW	08000000h (-2147483648) ~ 7FFFFFFFh (2147483647)								
		0133h	307		HI									
Element 1 of Formula 3		0134h	308		LOW	08000000h (-2147483648) ~ 7FFFFFFFh (2147483647)								
		0135h	309		HI									
Element 2 of Formula 3		0136h	310		LOW	08000000h (-2147483648) ~ 7FFFFFFFh (2147483647)								
	0137h	311		HI										
Element 3 of Formula 3	0138h	312		LOW	08000000h (-2147483648) ~ 7FFFFFFFh (2147483647)									
	0139h	313		HI										
Reserved	013Ah	314												
Reserved	013Bh	315												
Reserved	013Ch	316												
Reserved	013Dh	317												
Reserved	013Eh	318												
Reserved	013Fh	319												
Error status	Calculation Overflow	Formula 1	0140h	320	0	B0= Element 1	B1= Element 2	B2= Element 3	B3= Formula 1					
		Formula 2				B4= Element 1	B5= Element 2	B6= Element 3	B7= Formula 2					
		Formula 3				B8= Element 1	B9= Element 2	B10= Element 3	B11= Formula 3					
		Head A				B12= Out of range								
	Head B				B13= Out of range									
Reserved		0141h	321											
Reserved		0142h	322											
Reserved		0143h	323											
Unit status	Current Bank number	0144h	324	0	0 ~ 59 = Bank 0 ~ 59									
	Version	0145h	325		Version									
	Q1~Q5 and source status	0146h	326	0	B0=Head A	B1=Head B	B2= Formula 1	B3= Formula 2	B4= Formula 3	B5= Receiving data 1	B6= Receiving data 2			
					B11=Q1	B12=Q2	B13=Q3	B14=Q4	B15=Q5					
	Response speed (µs)	0147h	327											
Storage current pointer	0148h	328	0	LOW	0 ~ 262143 (When the pointer reaches end and "Pointer end control" is 0=Stop, it will stop at 262143. When "Pointer end control" is 1= Continue from start, it restarts from 0.)									
	0149h	329		HI										
Storage overflow	014Ah	330			0= Pointer is less than 262143	1= Overflow								
Reserved		014Bh	331											
Reserved		014Ch	332											
Reserved		014Dh	333											
Loaded data	1st	Depends on "Source of data" address 120	014Eh	334		LOW	Depends on "Source of data" address 120							
	~	~	014Fh	335		HI								
16216th	Depends on "Source of data" address 120	7FFCh	32764		LOW	Depends on "Source of data" address 120								
		7FFDh	32765		HI									
Reserved		7FFEh	32766											
		7FFFh	32767											

● Waveform mode

When Y14, Y15 “Head A/B Waveform mode” is ON, shared memory address 334 ~ 1329 will be updated with Waveform data.

Item		Address		Default	Parameters	
		Hex.	Decimal			
Waveform data	Head A	Threshold level	014Eh	334		0 ~ 255 (0FFh): UQ1-01 0 ~ 4095 (0FFFh): UQ1-02 65535 (0FFFFh): UQ1-02 (non applicable sensor head)
		Peak position 1	014Fh	335		0 ~ 511 (01FFh)
		Peak position 2	0150h	336		0 ~ 511 (01FFh)
		Waveform data 1	0151h	337		0 ~ 255 (0FFh)
		~	~			
		Waveform data 480 (UQ1-01 end of data)	0331h	817		0 ~ 255 (0FFh)
		Waveform data 508 (UQ1-02 end of data)	034Dh	845		0 ~ 4095 (0FFFh)
	Head B	Threshold level	034Eh	846		0 ~ 255 (0FFh): UQ1-01 0 ~ 4095 (0FFFh): UQ1-02 65535 (0FFFFh): UQ1-02 (non applicable sensor head)
		Peak position 1	034Fh	847		0 ~ 511 (01FFh)
		Peak position 2	0350h	848		0 ~ 511 (01FFh)
		Waveform data 1	0351h	849		0 ~ 255 (0FFh)
		~	~			
		Waveform data 480 (UQ1-01 end of data)	0531h	1329		0 ~ 255 (0FFh)
		Waveform data 508 (UQ1-02 end of data)	054Dh	1357		0 ~ 4095 (0FFFh)

3.1.3 X / Y device in detail

X (input) device

X (input) device is input from UQ1 unit to PLC. It can't be driven by PLC.

Y (output) device

Y (output) device is output from PLC to UQ1 unit. It can't be driven by UQ1 unit.

● X (input) device in detail

X00

Reserved. Not to be used.

X01~X0A Upper/Lower status

When Q1~Q5 output is larger (smaller) than Upper/Lower threshold, it will be ON accordingly.

X0B~X0F Judge status

When Q1~Q5 output is in the Upper and Lower threshold level.

Tips

About X01~X0F;

When setup is done correctly, one out of these status will be ON.

For example, regarding Q1, one out of X01~X0A and X0B will be ON.

If the source of the control output (shared memory address 32 for Q1 for example) is "NONE", these device won't be ON.

BUSY status (X10 / X11 / X12 / X13 / X14 / X15)

BUSY will be activated when UQ1 series can't get measurement result from CD5/CD33.

While the BUSY is ON, reading shared memory will be stopped.

Please don't write anything on shared memory while BUSY is active.

X10 BUSY: Over writing common setup

BUSY (X10) will be ON while over writing common setup.

After activating "Y10 Over writing common setup", common setup parameters in shared memory will be over written into the ROM of UQ1 unit.

X11 BUSY: Over writing Bank setup

BUSY (X11) will be ON while over writing Bank setup.

After activating "Y11 Over writing Bank setup", Bank setup parameters in shared memory will be over written into the ROM of UQ1 unit.

X12 BUSY: Switching Bank setup

BUSY (X12) will be ON while switching Bank setup.

After activating “Y08 Switching Bank setup”, read out setup parameters of the Bank number specified at shared memory address 102.

X13 BUSY: Getting data stored

BUSY (X13) will be ON while getting data into shared memory.

After activating “Y0F Getting data stored”, get the data from the internal memory of UQ1 unit into shared memory. Please refer [3.2.6 Storage setup].

X14 ~ X15 BUSY: Switching Head A/B monitoring mode

BUSY (X14, X15) will be ON while switching monitoring mode of the Head A/B at the up edge and down edge of “Y14/15 Head A/B Waveform mode”.

X16 ~ X17 Head A/B out of range alarm

Alarm (X16, X17) will be ON while CD5/CD33 sensor head is alarming that it can not detect any objects in the range whatever the monitoring mode is.

When the sensor head detects the object in the range, the alarm will be OFF.

Error status (X18 / X19 / X1A / X1B / X1C / X1D / X1E / X1F)

Error will be ON when the communication or measurement is not done correctly.

Once, the error is ON, it won't be OFF even the conditions are released.

Please proceed one of following to release this error.

- Power OFF and Power ON
- Activate “Y16 Error release”

X18 ~ X19 Head A/B connection error

Error (X18, X19) will be ON when the RS-422 connection between CD5/CD33 sensor head and UQ1 unit has problems.

This Error won't be ON if the sensor head which has connection problem is not assigned as source of output (Q1~Q5).

X1A FirST data error

Error (X1A) will be ON when the UQ1 unit can't get data from another UQ1 unit next to it.

This Error won't be ON if the input data 1 and 2 are not assigned as source of output (Q1~Q5).

X1B ~ X1F Q1~Q5 Error

This Error (X1B~X1F) will be ON when one of following two conditions is fulfilled.

- The sensor head that is assigned to the output (Q1~Q5) is not connected.
- Overflowed while calculation that is assigned to the output (Q1~Q5).

This Error won't be ON if the source of output (Q1~Q5) is “NONE”.

● Y (output) device in detail

Y00 ~ Y04 Zero reset

Zero reset input for the output Q1~Q5.

It resets measured result to "0" at the up edge of the zero reset input adjusting offset.

BUSY (X11) will be ON while Zero reset.

Y08 Switching Bank

By activating "Y08", it switches Bank.

It reads out Bank setup parameters of the Bank number specified at shared memory address 102 and over write shared memory address 128~157 at up edge of this device.

BUSY (X12: Switching Bank) will be ON while switching Bank.

Y09 RESET

By activating "Y09", it resets the UQ1 unit.

It clears the value held in "Hold mode".

While Data clear timing (shared memory address 122) is "1=only when RESET", it clears the value held in "Hold mode".

Y0A ~ Y0E Trigger IN

Trigger input for sensor head A/B and calculation 1/2/3.

Trigger can be input to Y device and terminal block.

Tips

When the trigger is input from terminal block, It works regardless of scan timing of the sequencer.

Y0F Getting Data stored

Start transfer of data stored.

While measurement, the data is stored into internal memory of the unit.

By activating "Y0F", the data is transferred from internal memory to shared memory.

Please refer [3.2.6 Storage setup].

While transferring the data, X13 BUSY: Getting Data stored will be ON.

Y10 Over writing common setup

Start over writing common setup parameters.

Just changing parameters in the shared memory doesn't affect actual process of the unit.

By activating this "Y10" device, the parameters are over written on the memory for processing and come into effect.

The parameters to be over written are in the shared memory address 0~127 except reserved area.

It reads out Bank setup parameters of the Bank number specified at shared memory address 102 and over write shared memory address 128~157 at up edge of this device.

While over writing the data, X10 BUSY Over writing common setup will be ON.

Y11 Over writing Bank setup

Start over writing Bank setup parameters including upper and lower threshold.

Just changing parameters in the shared memory doesn't affect actual process of the unit.

By activating this "Y11" device, the parameters are over written on the memory for processing and come into effect.

The parameters to be over written are in the shared memory address 128~157 except reserved area.

While over writing the data, X11 BUSY Over writing Bank setup will be ON.

Y12 ~ Y13 LASER OFF

You can make the laser output of each CD5/CD33 sensor head OFF by activating this device.

While laser is OFF, measurement is stopped.

Y14 ~ Y15 Waveform mode

By activating this device, monitoring mode of each sensor head is changed to Waveform monitoring mode. While it's Waveform mode, the sensor head doesn't measure but update the Waveform data on.

Y16 Error release

You can release Error by activating this device.

Besides activating this device, you can release the Error by restart power supply of the UQ1 unit.

3.1.4 Parameters in shared memory

Major parameters in the shared memory are as follows.

Common setup parameters

Address: 0~126

Parameters for CD5 sensor head and UQ1 unit.

Please change parameters here firstly to change setup.

Common setup parameters consist of following.

- Setup of sensor head A/B
- High speed mode (ON/OFF)
- Output and Calculation
- Etc.
- Output setup / Trigger input
- Data storing

Initialize

Address: 127

Initialize setup of UQ1 unit.

Bank setup parameters

Address: 128~159

Threshold level and offset for every Bank.

When the Bank is switched, the parameters will be over written.

The parameters include:

- Q1~Q5 Upper/Lower threshold
- Q1~Q5 Offset

Measurement result

Address: 160~319

Result (value) will be shown.

The result include:

- Q1~Q5 result
- Center stand off
- Measurement result
- Calculation factor

Error status

Address: 320~323

Shows every error status.

Unit status

Address: 324~333

Shows every status of the unit.

Loaded data

Address: 334~32767

Will be updated when getting data from internal memory.

Please refer [3.2.6 Storage setup] about setup of getting data stored.

Waveform data

Address: 334~1329

Will be updated when Waveform monitoring mode.

Tips

Please don't access "Reserved" area of shared memory.

It may cause malfunction of UQ1 unit.

3.2 Parameters in detail

3.2.1 Sensor head setup

Following parameters (shared memory address 0~30) are for setup of CD5/CD33 sensor head.

■ UQ1-01

Item	Address		Default	Parameters								
	Hex.	Decimal										
Sensor head A setup Over written by Y10=1	Measurement target	0000h	0	0	0=Surface	1=Flip side	2= Glass thickness		3= Glass gap			
	Diffuse / Specular	0001h	1	0	0=Diffuse	1=Specular						
	Laser power	0002h	2	5	0=OFF	1~5 (5: MAX.)						
	Sensitivity	0003h	3	11	0=Min.	1 ~ 10	11=AUTO					
	Threshold	0004h	4	0	0~14	15=AUTO						
	Shift	0005h	5	0	LOW	-50000000 ~ +50000000 (depends on the sensor head)						
		0006h	6		HI							
	Span	0007h	7	2710H	LOW	0 ~ 9C3Fh (0 ~ 39999) Example: 10000 means Span=1.0000						
		0008h	8	(10000)	HI							
	Moving average number	0009h	9	8	0=1 time	1=2 times	2=4 times	3=8 times	4=16 times	5=32 times	6=64 times	7=128 times
	Alarm processing		10	0	0=Clamp	1=Hold						
	Sampling period	000Bh	11	0	0=100us	1=200us	2=400us	3=800us	4=1600us	5=3200us	6=AUTO	
	Reserved	000Ch	12									
Reserved	000Dh	13										
Sensor head B setup Over written by Y10=1	Measurement target	000Eh	14	0	0=Surface	1=Flip side	2= Glass thickness		3= Glass gap			
	Diffuse / Specular	000Fh	15	0	0=Diffuse	1=Specular						
	Laser power	0010h	16	5	0=OFF	1~5 (5: MAX.)						
	Sensitivity	0011h	17	11	0=Min.	1 ~ 10	11=AUTO					
	Threshold	0012h	18	0	0~14	15=AUTO						
	Shift	0013h	19	0	LOW	-50000000 ~ +50000000 (depends on the sensor head)						
		0014h	20		HI							
	Span	0015h	21	2710H	LOW	0 ~ 9C3Fh (0 ~ 39999) Example: 10000 means Span=1.0000						
		0016h	22	(10000)	HI							
	Moving average number	0017h	23	8	0=1 time	1=2 times	2=4 times	3=8 times	4=16 times	5=32 times	6=64 times	7=128 times
	Alarm processing		24	0	0=Clamp	1=Hold						
	Sampling period	0019h	25	0	0=100us	1=200us	2=400us	3=800us	4=1600us	5=3200us	6=AUTO	
	Reserved	001Ah	26									
Reserved	001Bh	27										
Sensor head A/B setup	Cross talk prevention function	001Ch	28	0	0=OFF	1=ON						
	Filter choice	001Dh	29	0	0=OFF	1=High pass		2=Low pass				
	Cutoff frequency	001Eh	30	0	0=High	~ 7= Low						

■ UQ1-02

Item	Address		Default	Parameters							
	Hex.	Decimal									
Sensor head A setup Over written by Y10=1	Measurement target	0000h	0	0	0= Peak	1= Surface	2=Flip side	3= Glass thickness			
	Reserved	0001h	1								
	Laser	0002h	2	1	0=OFF	1=ON					
	Reserved	0003h	3								
	Reserved	0004h	4								
	Shift	0005h	5	0	LOW	-50000000 b~ +50000000					
		0006h	6		HI	(Depends on the sensor head. Please refer [3.2.1 Sensor head setup])					
	Span	0007h	7	2710h	LOW	0 ~ 9C3Fh (0 ~ 39999) Example: 10000 means Span=1.0000					
		0008h	8	(10000)	HI						
	Moving average number	0009h	9	1	0= 1 time	1=16 times	2=64 times				
	Alarm processing	000Ah	10	0	0=Clamp	1=Hold					
	Sampling period	000Bh	11	0	0=500us (250mm type: 750us)				1=1000us	2=1500us	3=2000us
	Reserved	000Ch	12								
Reserved	000Dh	13									
Sensor head A setup Over written by Y10=1	Measurement target	000Eh	14	0	0= Peak	1= Surface	2=Flip side	3= Glass thickness			
	Reserved	000Fh	15								
	Laser	0010h	16	1	0=OFF	1=ON					
	Reserved	0011h	17								
	Reserved	0012h	18								
	Shift	0013h	19	0	LOW	-50000000 b~ +50000000					
		0014h	20		HI	(Depends on the sensor head. Please refer [3.2.1 Sensor head setup])					
	Span	0015h	21	2710h	LOW	0 ~ 9C3Fh (0 ~ 39999) Example: 10000 means Span=1.0000					
		0016h	22	(10000)	HI						
	Moving average number	0017h	23	1	0= 1 time	1=16 times	2=64 times				
	Alarm processing	0018h	24	0	0=Clamp	1=Hold					
	Sampling period	0019h	25	0	0=500us (250mm type: 750us)				1=1000us	2=1500us	3=2000us
	Reserved	001Ah	26								
Reserved	001Bh	27									

CD5/CD33 sensor head has setup parameters same as shared memory 0~25. These parameters will be over written with the parameters in shared memory when UQ1 unit detects CD5/CD33 sensor head connected.

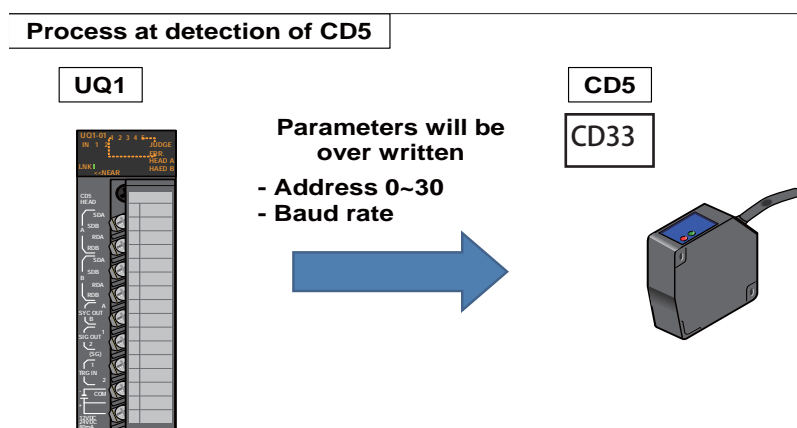

● Measurement target

Choose measurement target mode.

- Peak: Most reflective point (only UQ1-02)
- Surface: Measurement target is the surface of the object. Please use this mode normally.
- Flip side: 2nd surface of the object. Flip side of glass plate for example.
- Glass thickness: Measures distance between 1st surface and 2nd surface.
Transparent glass thickness for example. Available with only specular type sensor head.
- Glass gap: Measures distance between 2nd surface and 3rd surface.
Gap between layered glasses for example. Available with only specular type sensor head.

[Parameters]

UQ1-01	UQ1-02
0: Surface	0: Peak
1: Flip side	1: Surface
2: Glass thickness	2: Flip side
3: Glass gap	3: Glass thickness

● Diffuse / Specular (UQ1-01)

Specify reflection mode of the laser. Please use diffuse mode for the surface that is not reflective or glossy. Please use specular mode for reflective surface like glass or clean metal surface.

● Laser power (UQ1-01) / Laser (UQ1-02)

Specify laser power from 0 to 5 for CD5 connected to UQ1-01. It switches laser power ON or OFF for CD33 connected to UQ1-02. When it's 0, it stops measurement.

[Parameters]

UQ1-01	UQ1-02
0 : Laser OFF	0: Laser OFF
1 ~ 5 : Laser power (1: low ~ 5: High)	1: Laser ON

● Sensitivity (UQ1-01)

Specify sensitivity of laser sensor in the sensor head. It should be set 11 (Auto) normally. When it's 11 (auto), the sensor adjusts the sensitivity automatically depends on the strength of the reflection. It takes 2msec. (Max.) to adjust so please fix the sensitivity when the reflection changes quickly and drastically.

Example: When the object is reflective metal surface and the object continues disappearing from its view and appear in a view quickly, measurement could be stable by fixing sensitivity.

[Parameters]

0~10 : 0 (weak) ~ 10 (strong)

11 : AUTO

● Threshold (UQ1-01)

Specify threshold level of CD5 to detect peak point of Waveform.

It should be "0" normally.

Tips

Please adjust the threshold level checking Waveform adequately when the object is transparent.

Please refer "Setup software".

Setting "15: Auto" may make measurement stable but might cause less linearity.

[Parameters]

0~14 : Threshold 0 (low) ~ 14 (high)

15 : AUTO

● Shift / Span

Setup Shift and Span to cancel deviation of position and gradient of the sensor head. Please refer "Setup software" when you calibrate the sensor. Setup range of Shift is as follows depending to sensor head.

Sensor type	Range of Shift	
	Minimum	Maximum
CD5-Lx25	-100000 (-1mm)	100000 (1mm)
CD5-x30	-500000 (-5mm)	500000 (5mm)
CD5-x85	-2000000 (-20mm)	2000000 (20mm)
CD5-W350	-10000000 (-100mm)	10000000 (100mm)
CD5-W500	-20000000 (-200mm)	20000000 (200mm)
CD5-W2000	-50000000 (-500mm)	50000000 (500mm)

Please calculate Shift and Span as following.

[Shift calculation]

Example (CD5-x85): When correct +85.400mm to +85.000mm

Stand off: 85mm

Measurement range: ±20mm

$(85.000 - 85.400) / (20 * 2) = -0.0100$

Please input -00100

[Span calculation]

Example (CD5-x85): When correct the distance 10.100mm to 10.000mm

$10.100/10.000=1.0100$

Please input 10100

● Moving average number

The bigger number, the more stable measurement is and counteract roughness of the surface.

The smaller number, the higher response speed is and detect quick change of the distance.

● Alarm processing

Specify the process when the sensor head A/B malfunction.

[Parameters]

0: Clamp (output "99999999" when malfunction)

1: Hold (hold previous measurement value when malfunction. It doesn't output "X16, X17 out of range alarm".)

● Sampling period

Specify sampling period of CD5 sensor head.

The shorter period, the faster response but sensitivity will be worse.

When the sampling period is set "6: AUTO", sampling period will be adjusted and optimized automatically (only with UQ1-01)

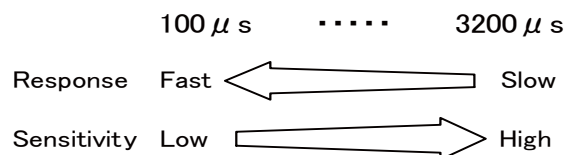

[Parameters]

UQ1-01	UQ1-02
0: 100us	0: 500us / 750us (250mm type)
1: 200us	1: 1000us
2: 400us	2: 1500us
3: 800us	3: 2000us
4: 1600us	
5: 3200us	
6: AUTO	

● Cross talk prevention function (UQ1-01)

When multiple CD5 sensor heads target same point, measurement may be unstable because of cross talk.

You can prevent cross talk by setting "Cross talk prevention function" ON. Please note that sampling period will be 6 times in that case.

Please set this parameter OFF when there is no possibility of cross talk.

● Filter choice (UQ1-01)

You can choose frequency band “High pass filter” or “Low pass filter” for UQ1 series.

- High pass filter: You can get higher frequency band more than the cutoff frequency.
- Low pass filter : You can get low frequency band less than the cutoff frequency.

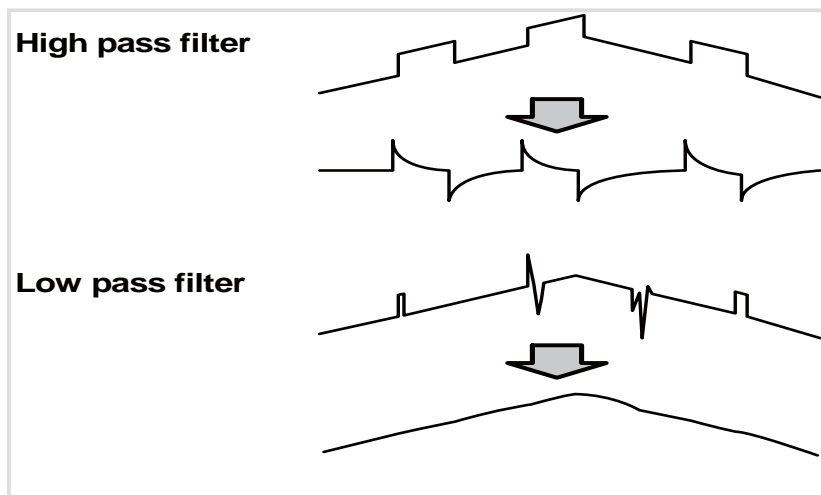

[Parameters]

- 0: OFF
- 1: High pass filter
- 2: Low pass filter

Tips

- When set High pass filter or Low pass filter, please set Moving average number (shared memory address 9, 23) as "0: 1 time".
-

● Cutoff frequency (UQ1-01)

Specify Cutoff frequency for High or Low pass filter.

Please choose the cutoff frequency from 8 level. Actual cutoff frequency depends on the sampling period

Please refer “6.1.1 Cutoff frequency of the filter” for actual cutoff frequency.

[Parameters]

- 0 ~ 7: Frequency level (0: High ~ 7: low)

3.2.2 High speed mode

Item	Address		Default	Parameters		
	Hex.	Decimal				
High speed mode	001Fh	31	0	0=OFF	1=ON	(It doesn't do averaging when this parameter is 1=ON. "Auto average" and "Average" in measured result will be "0".)

It speeds up calculation by not doing averaging in High speed mode.

This mode to be used when process time of UQ1 series is longer than sampling period of CD5 sensor.

If you use averaging of measured data, this parameter must be "0=OFF".

You can confirm current process time at "Process time (shared memory address 327)".

[Parameters]

0: High speed mode=OFF (all of measured data at shared memory address 176~289 will be updated.)

1: High speed mode=ON (only "Auto average" and "Average" in measured data at shared memory address 176~289 will not be updated.)

3.2.3 Q1~Q5 / Calculation setup

Item	Address		Default	Parameters							
	Hex.	Decimal									
Q1 Source	0020h	32	0	0=A	1=B	2= Formula 1	3= Formula 2	4= Formula 3	5= Receiving data1	6= Receiving data2	7= None
Q1 Hold	0021h	33	0	0= None	1= Sample	2= Peak	3= Bottom	4= Peak to Peak	5= Average		
Q2 Source	0022h	34	1	0=A	1=B	2= Formula 1	3= Formula 2	4= Formula 3	5= Receiving data1	6= Receiving data2	7= None
Q2 Hold	0023h	35	0	0= None	1= Sample	2= Peak	3= Bottom	4= Peak to Peak	5= Average		
Q3 Source	0024h	36	7	0=A	1=B	2= Formula 1	3= Formula 2	4= Formula 3	5= Receiving data1	6= Receiving data2	7= None
Q3 Hold	0025h	37	0	0= None	1= Sample	2= Peak	3= Bottom	4= Peak to Peak	5= Average		
Q4 Source	0026h	38	7	0=A	1=B	2= Formula 1	3= Formula 2	4= Formula 3	5= Receiving data1	6= Receiving data2	7= None
Q4 Hold	0027h	39	0	0= None	1= Sample	2= Peak	3= Bottom	4= Peak to Peak	5= Average		
Q5 Source	0028h	40	7	0=A	1=B	2= Formula 1	3= Formula 2	4= Formula 3	5= Receiving data1	6= Receiving data2	7= None
Q5 Hold	0029h	41	0	0= None	1= Sample	2= Peak	3= Bottom	4= Peak to Peak	5= Average		
Formula source 1-1	002Ah	42	0	0= None	1=A	2=B	3= Receiving data 1	4= Receiving data 2	5= Fixed value 1-1		
Formula source 1-2	002Bh	43	0	0= None	1=A	2=B	3= Receiving data 1	4= Receiving data 2	5= Fixed value 1-2		
Formula source 1-3	002Ch	44	0	0= None	1=A	2=B	3= Receiving data 1	4= Receiving data 2	5= Fixed value 1-3		
Formula source 1-4	002Dh	45	0	0= None	1=A	2=B	3= Receiving data 1	4= Receiving data 2	5= Fixed value 1-4		
Formula source 1-5	002Eh	46	0	0= None	1=A	2=B	3= Receiving data 1	4= Receiving data 2	5= Fixed value 1-5		
Reserved	002Fh	47									
Fixed value for Formula source 1-1	0030h	48	0	LOW	080000000 h (-2147483648) ~ 7FFFFFFFh (2147483647)						
	0031h	49		HI							
Fixed value for Formula source 1-2	0032h	50	0	LOW	080000000 h (-2147483648) ~ 7FFFFFFFh (2147483647)						
	0033h	51		HI							
Fixed value for Formula source 1-3	0034h	52	0	LOW	080000000 h (-2147483648) ~ 7FFFFFFFh (2147483647)						
	0035h	53		HI							
Fixed value for Formula source 1-4	0036h	54	0	LOW	080000000 h (-2147483648) ~ 7FFFFFFFh (2147483647)						
	0037h	55		HI							
Fixed value for Formula source 1-5	0038h	56	0	LOW	080000000 h (-2147483648) ~ 7FFFFFFFh (2147483647)						
	0039h	57		HI							
Operator 1-1	003Ah	58	0	0= +	1= -	2= *	3=+				
Operator 1-2	003Bh	59	0	0= +	1= -	2= *	3=+				
Operator 1-3	003Ch	60	0	0= +	1= -	2= *	3=+				
Operator 1-4	003Dh	61	0	0= +	1= -	2= *	3=+				
Formula source 2-1	003Eh	62	0	0= None	1=A	2=B	3= Receiving data 1	4= Receiving data 2	5= Fixed value 2-1		
Formula source 2-2	003Fh	63	0	0= None	1=A	2=B	3= Receiving data 1	4= Receiving data 2	5= Fixed value 2-2		
Formula source 2-3	0040h	64	0	0= None	1=A	2=B	3= Receiving data 1	4= Receiving data 2	5= Fixed value 2-3		
Formula source 2-4	0041h	65	0	0= None	1=A	2=B	3= Receiving data 1	4= Receiving data 2	5= Fixed value 2-4		
Formula source 2-5	0042h	66	0	0= None	1=A	2=B	3= Receiving data 1	4= Receiving data 2	5= Fixed value 2-5		
Reserved	0043h	67									
Fixed value for Formula source 2-1	0044h	68	0	LOW	080000000 h (-2147483648) ~ 7FFFFFFFh (2147483647)						
	0045h	69		HI							
Fixed value for Formula source 2-2	0046h	70	0	LOW	080000000 h (-2147483648) ~ 7FFFFFFFh (2147483647)						
	0047h	71		HI							
Fixed value for Formula source 2-3	0048h	72	0	LOW	080000000 h (-2147483648) ~ 7FFFFFFFh (2147483647)						
	0049h	73		HI							
Fixed value for Formula source 2-4	004Ah	74	0	LOW	080000000 h (-2147483648) ~ 7FFFFFFFh (2147483647)						
	004Bh	75		HI							
Fixed value for Formula source 2-5	004Ch	76	0	LOW	080000000 h (-2147483648) ~ 7FFFFFFFh (2147483647)						
	004Dh	77		HI							
Operator 2-1	004Eh	78	0	0= +	1= -	2= *	3=+				
Operator 2-2	004Fh	79	0	0= +	1= -	2= *	3=+				
Operator 2-3	0050h	80	0	0= +	1= -	2= *	3=+				
Operator 2-4	0051h	81	0	0= +	1= -	2= *	3=+				
Formula source 3-1	0052h	82	0	0= None	1=A	2=B	3= Receiving data 1	4= Receiving data 2	5= Fixed value 3-1		
Formula source 3-2	0053h	83	0	0= None	1=A	2=B	3= Receiving data 1	4= Receiving data 2	5= Fixed value 3-2		
Formula source 3-3	0054h	84	0	0= None	1=A	2=B	3= Receiving data 1	4= Receiving data 2	5= Fixed value 3-3		
Formula source 3-4	0055h	85	0	0= None	1=A	2=B	3= Receiving data 1	4= Receiving data 2	5= Fixed value 3-4		
Formula source 3-5	0056h	86	0	0= None	1=A	2=B	3= Receiving data 1	4= Receiving data 2	5= Fixed value 3-5		
Reserved	0057h	87									
Fixed value for Formula source 3-1	0058h	88	0	LOW	080000000 h (-2147483648) ~ 7FFFFFFFh (2147483647)						
	0059h	89		HI							
Fixed value for Formula source 3-2	005Ah	90	0	LOW	080000000 h (-2147483648) ~ 7FFFFFFFh (2147483647)						
	005Bh	91		HI							
Fixed value for Formula source 3-3	005Ch	92	0	LOW	080000000 h (-2147483648) ~ 7FFFFFFFh (2147483647)						
	005Dh	93		HI							
Fixed value for Formula source 3-4	005Eh	94	0	LOW	080000000 h (-2147483648) ~ 7FFFFFFFh (2147483647)						
	005Fh	95		HI							
Fixed value for Formula source 3-5	0060h	96	0	LOW	080000000 h (-2147483648) ~ 7FFFFFFFh (2147483647)						
	0061h	97		HI							
Operator 3-1	0062h	98	0	0= +	1= -	2= *	3=+				
Operator 3-2	0063h	99	0	0= +	1= -	2= *	3=+				
Operator 3-3	0064h	100	0	0= +	1= -	2= *	3=+				
Operator 3-4	0065h	101	0	0= +	1= -	2= *	3=+				

Q1~Q5 / Calculation setup

UQ1 has 5 control outputs, Q1~Q5, in the unit that judge measured result OK or NG.

Each control output has Source and Hold mode to set.

● Q1 ~ Q5 source

Specify the source of each control output.

[Parameters]

- 0: Head A
- 1: Head B
- 2: Formula 1
- 3: Formula 2
- 4: Formula 3
- 5: Receiving data 1
- 6: Receiving data 2
- 7: None

● Q1 ~ Q5 Hold

Specify Hold mode for judging Q1~Q5.

[Parameters]

- 0: Hond None
- 1: Sample Hold
- 2: Peak Hold
- 3: Bottom Hold
- 4: Peak to Peak Hold
- 5: Average Hold (doesn't work when it's High speed mode)

● Formula 1 ~ 3

Specify formula for the calculation. It can be source of Q1~Q5.

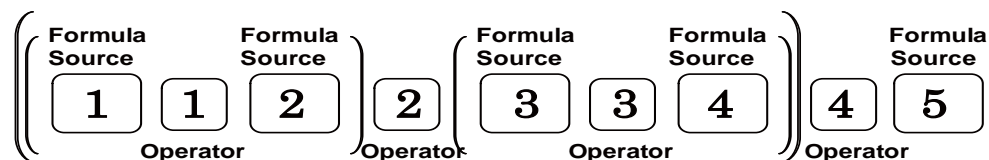

● Formula source (1~5)

Specify source of the formula.

[Parameters]

- 0: None
- 1: Measurement result of Head A
- 2: Measurement result of Head B
- 3: Receiving data 1 (FlrST transmit data 1 from next unit)
- 4: Receiving data 2 (FlrST transmit data 2 from next unit)
- 5: Fixed value

● Operator

Specify operator of the formula.

You can use "+: addition", "-: subtraction", "*: multiplication" and "÷: division".

[Parameters]

- 0: +
- 1: -
- 2: *
- 3: ÷

● Example of Formula setup

Actual formula is as following.

Calculation of thickness

Because the distance between two sensor heads is fixed, the object thickness is calculated by $t=(A+B)+L$. Please set "L" by calibration using a gauge.

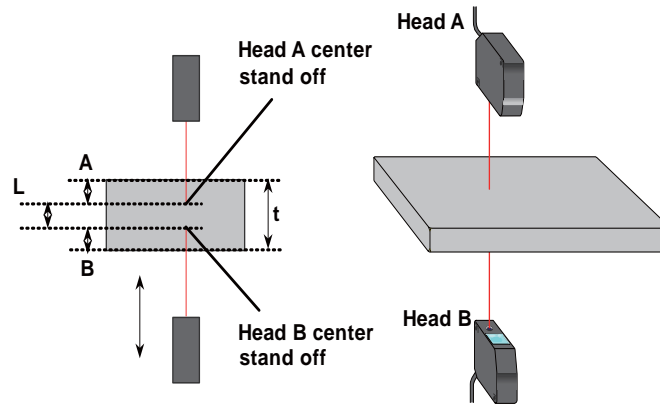

For example, when the thickness of the object is 10mm and "A+B" is 9.2mm, set the formula as follows. Set the "Fixed value" as "0.800" ($L=t-A-B$ then $10\text{mm} - 9.2\text{mm} = 0.8\text{mm}$).

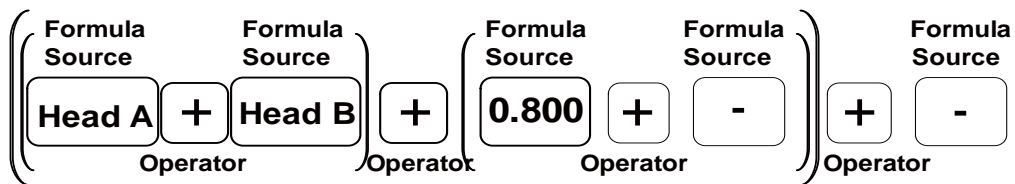

Calculation of step height

Height of the step from the base is calculated by " $H=A-B$ ".

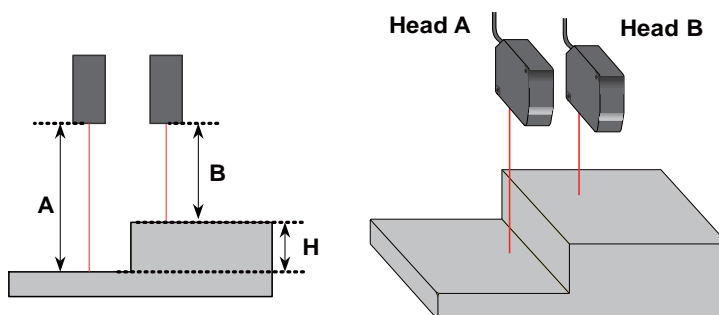

Formula for calculation of step height is as follows.

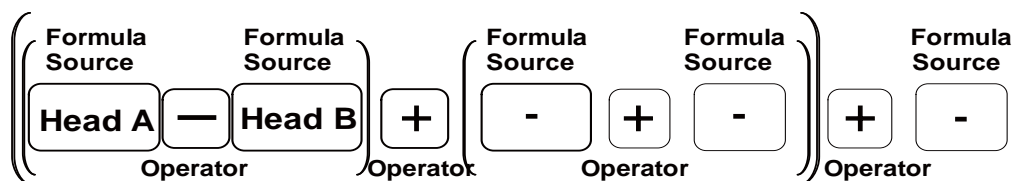

Calculation of inclination

Inclination is calculated with distance between sensor heads (Fixed value “L”).
The formula is as follows.

$$\theta = \tan^{-1} \left(\frac{A - B}{L} \right) \xrightarrow{\text{Approximation}} \theta = (A - B) / L$$

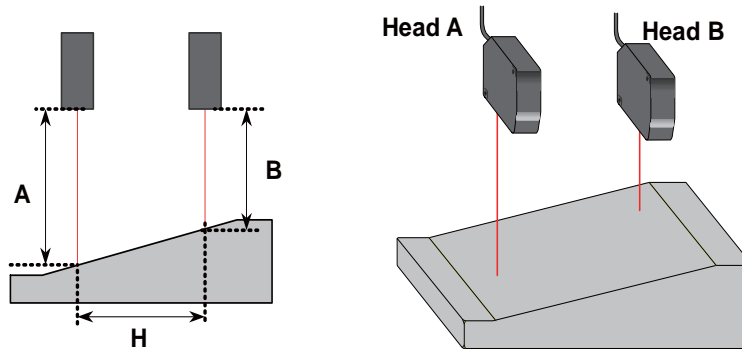

When the distance between two sensor heads is 80mm for example, the formula is as follows.

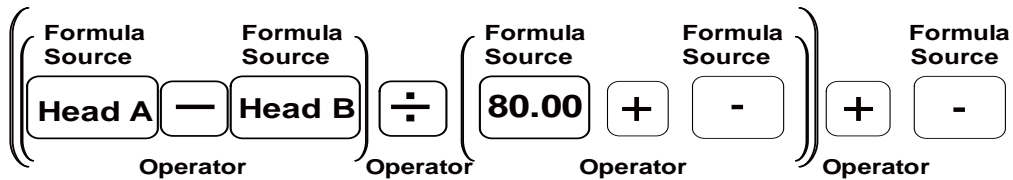

Getting measured data from adjoining unit

The measured data from adjoining unit is treated as “Receiving data 1, 2”.
The data is transmitted from adjoining unit at slave side. Setup should be done at the slave unit. Please refer “2.1.1 FlrST communication”.

For example, when calculating average of two Head A connected to each UQ1 unit, setup is as follows.

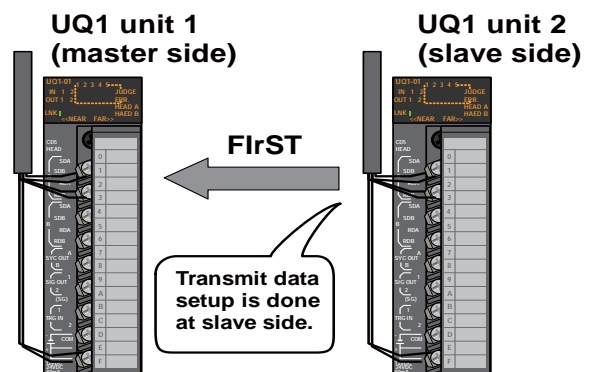

- UQ1 unit 1 (master side)
Setup the formula as follows.

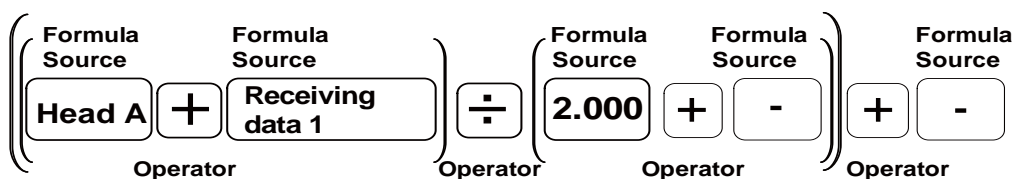

Parameters in detail

- UQ1 unit 2 (slave side)

Setup as follows.

FIRST transmit data 1 setup (shared memory address 109): 0 (Head A)

Tips

- Process time will be longer when you use calculation.

You can shorten the process time by making calculation not needed inactive setting "Trigger IN Calculation 1, 2, 3" (Y0C, Y0D, Y0E) as ON.

- When you use "*" or "÷" for the operator, process time will be longer.
- FIRST communication will be done every UQ1 updating timing.

When FIRST communication is done with multiple UQ1 units, the communication delays for total cycle of updating period.

Getting data from the unit not adjoining

For example, when you use 3 UQ1 units connected as following picture, the data from unit 3 can be transferred to unit 1 through unit 2. Unit 1 can't get the data from unit 3 directly.

When you calculate step height using two Head A connected to unit 1 and unit 3, setup should be done as following.

In this example case, Formula 3 of unit 2 is used to assign Receiving data 1 as FlrST Transmit data 1.

Although, you can use Formula 1 or 2 as well.

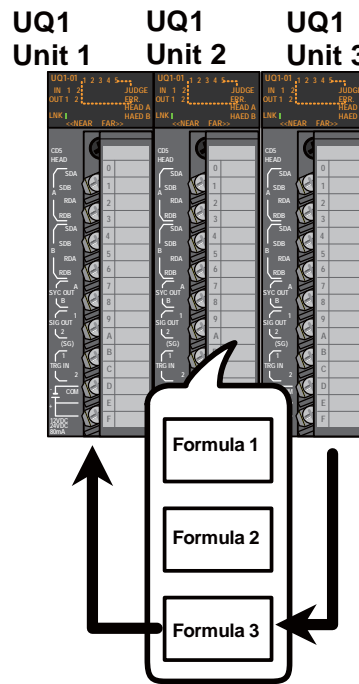

- UQ1 unit 1 (master)

Set the Formula as follows.

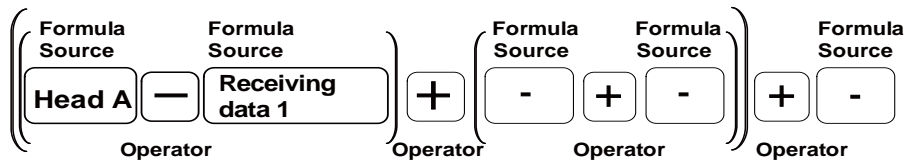

- UQ1 unit 2 (center unit)

Set the Formula and FlrST Transmit data 1 as follows.

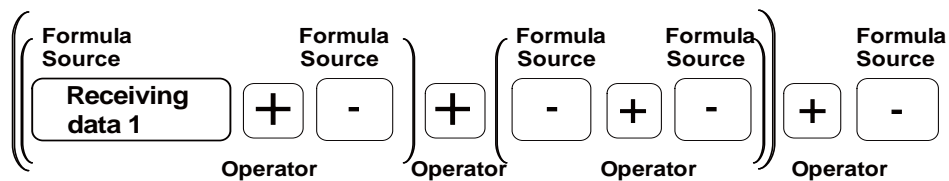

FlrST Transmit data 1 (shared memory address 109): 4 (Formula 3)

- UQ1 unit 3 (slave side)

Setup as follows.

FlrST Transmit data 1 (shared memory address 109): 0 (Head A)

3.2.4 Setup of other parameters (Etc.)

	Item	Address		Default	Parameters	
		Hex.	Decimal			
Etc.	Bank number	0066h	102	0	0 ~ 59 = Bank 0 ~ 59	
	Hold mode	0067h	103	0	0 = Auto (data clear when RESET) 1 = Normal (data clear when sampling starts)	
	Hysteresis	0068h	104	0	LOW	0 ~ 7FFFFFFFh (2147483647)
		0069h	105		HI	

● Bank number

Up to 60 threshold level of Q1~Q5 can be stored in the UQ1 unit.

Following threshold and offset are stored in the Bank.

- Q1~Q5 Upper/Lower threshold (shared memory address 128~147)
- Q1~Q5 Offset (shared memory address 148~157)

Over writing Bank setup

You can over write Bank setup parameters by following procedure.

- <1> Set Bank number to over write into "Bank number" (shared memory address 102)
- <2> Setup "Bank setup parameters" (shared memory address 128~159).
- <3> Set Y11: "Over writing Bank setup" ON.

While over writing Bank setup, X11 BUSY will be ON and accessing to shared memory stops.

Switching Bank

You can switch the Bank loading setup parameters by following procedure.

- <1> Set Bank number to switch to into "Bank number" (shared memory address 102)
- <2> Set Y08: "Switching Bank" ON.

While switching the Bank, X12 BUSY will be ON and accessing to shared memory stops.

● Hold mode

Specify process of Hold mode.

Please refer [3.3 Hold mode and process] in detail.

0: Auto Hold mode

- Update data while measuring
- Update data when the trigger is ON
- Clear the data when RESET is ON

1: Normal Hold mode

- While sampling, trigger is OFF, it doesn't reflect to the level.
- At the up edge of the trigger, it reflect to the level and fix.
- While sampling, trigger is OFF, it update the level internally.

● Hysteresis

Specify hysteresis as the distance between the level that Q1~Q5 turns ON and the level that Q1~Q5 goes OFF after turning ON. The unit is $0.01\mu\text{m}$

In the following example, Qx turns ON at A point there the level exceeds upper threshold. Then, Qx goes OFF at B point there the level goes under “Upper threshold - Hysteresis”.

This feature helps stabilizing the output when the level fluctuates around the threshold level.

Qx doesn't turn ON unless the level exceeds the threshold so Qx doesn't turn ON at D point there the level just exceeds “Upper threshold - Hysteresis”.

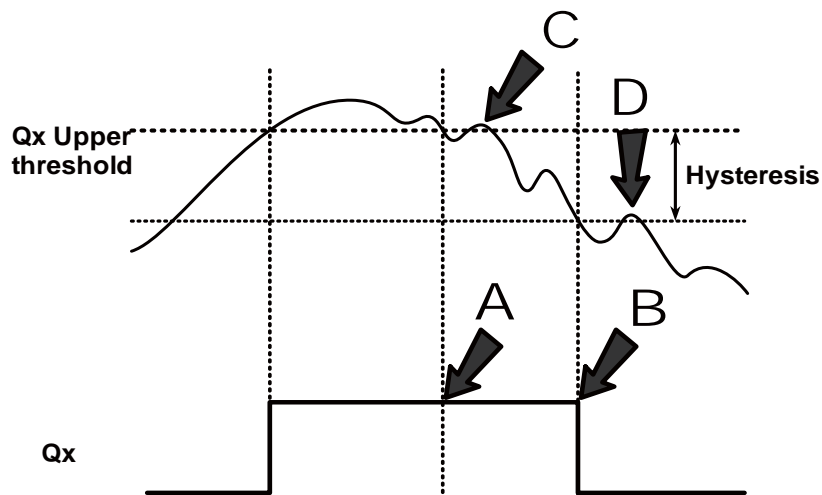

3.2.5 Input / Output setup

Item	Address		Default	Parameters								
	Hex.	Decimal										
Output setup	On delay	006Ah	106	0	0= None	1 ~ 0FFFFh (65535) ms				* Reflect to Signal Out 1, 2, X device		
	Off delay	006Bh	107	0	0= None	1 ~ 0FFFFh (65535) ms				* Reflect to Signal Out 1, 2, X device		
	One shot	006Ch	108	0	0=OFF	1=ON				* Reflect to Signal Out 1, 2, X device		
	FirST Transmit data 1 setup	006Dh	109	0	0= Head A	1= Head B	2= Formula 1	3= Formula 2	4=Formula 3	5= None		
	FirST Transmit data 1 Hold	006Eh	110	0	0= None	1= Sample	2= Peak	3= Bottom	4= Peak to Peak	5= Average		
	FirST Transmit data 2 setup	006Fh	111	1	0= Head A	1= Head B	2= Formula 1	3= Formula 2	4=Formula 3	5= None		
	FirST Transmit data 2 Hold	0070h	112	0	0= None	1= Sample	2= Peak	3= Bottom	4= Peak to Peak	5= Average		
	Signal Out 1	0071h	113	0	0=Q1	1=Q2	2=Q3	3=Q4	4=Q5	* ON when out side of threshold		
	Signal Out 2	0072h	114	1	0=Q1	1=Q2	2=Q3	3=Q4	4=Q5	* ON when out side of threshold		
Input setup	Signal Out logic	0073h	115	0	0= All normal	1= 1 is reverse	2= 2 is reverse	3= All reverse				
	Trigger timing of data sampling	0074h	116	0	0= OFF	1= ON	2= Up edge	3= Down edge	* RESET effects at up edge only			
	Trigger IN 1	0075h	117	0	0= RESET	1= Head A	2= Head B	3= Formula 1	4=Formula 2	5=Formula 3		
	Trigger IN 2	0076h	118	1	0= RESET	1= Head A	2= Head B	3= Formula 1	4=Formula 2	5=Formula 3		

Setup parameters regarding Input and Output.

● ON delay / OFF delay

Specify the delay time of output turning ON and OFF. The unit is msec.

When the width of ON or OFF time of measured result is shorter than ON delay or OFF delay like “A” and “B” in the following chart. ON delay and OFF delay affect all output.

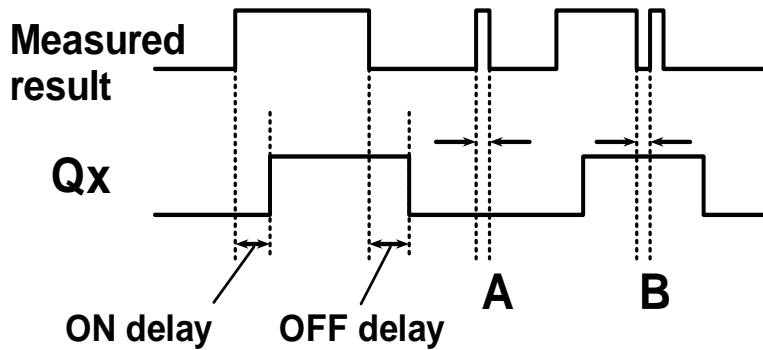

● One shot

Specify if output as one shot or not.

When One shot is ON, the output will be ON for the period specified by OFF delay.

One shot affects all output.

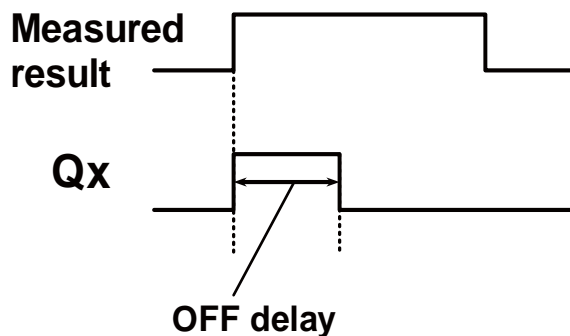

● FlrST Transmit data 1/2 setup, FlrST Transmit data 1/2 hold

Specify the source to send through FlrST to another UQ1 unit at master side.

The data sent from slave side will be assigned as “Receiving data 1/2” in the unit.

Please refer [2.1.1 FlrST communication]

At “FlrST Transmit data 1/2 hold”, specify the hold mode of the data to transmit.

Please refer [3.3 Hold mode and process]

● Signal Out 1/2

Specify the source to output from “Signal Out 1/2” at terminal block.

The indicator LED “OUT 1/2” will be ON when the output is ON.

[Parameters]

0: Q1

1: Q2

2: Q3

3: Q4

4: Q5

● Signal out logic

Specify the logic of the “Signal Out 1/2”.

[Parameters]

0: Normal (ON when the measurement result is out of threshold)

1: The logic of Signal out 1 is reverse (ON when the measurement result is in the threshold)

2: The logic of Signal out 2 is reverse (ON when the measurement result is in the threshold)

3: The logic of Signal out 1 and 2 is reverse (ON when the measurement result is in the threshold)

● Trigger timing of data sampling

Specify the timing of “Trigger IN” to sample the data.

When “RESET” is assigned for Trigger IN 1 or 2, the timing is up edge.

[Parameters]

0: OFF (when Trigger IN is OFF, it samples the data)

1: ON (when Trigger IN is ON, it samples the data)

2: Up edge (at the up edge of Trigger IN, it samples the data)

3: Down edge (at the down edge of Trigger IN, it samples the data)

● Trigger IN 1/2

Specify the source of “Trigger IN 1/2”.

The indicator LED “IN 1/2” will be ON when the input is ON.

[Parameters]

0: RESET (Y09)

1: Head A (Y0A)

2: Head B (Y0B)

3: Formula 1 (Y0C)

4: Formula 2 (Y0D)

5: Formula 3 (Y0E)

3.2.6 Storage setup

Item	Address		Default	Parameters							
	Hex.	Decimal									
Data store skip number	0077h	119		0=No skip 1 ~ 0FFFFh (65535)							
Source of data	0078h	120	0	0=Q1	1=Q2	2=Q3	3=Q4	4=Q5	5= Head A	6= Head B	7= Formula 1
				8= Formula 2	9= Formula 3	* Q1~Q5 will be added its offset.					
Hold mode	0079h	121	0	0= None	1= Sample	2= Peak	3=Bottom	4= Peak to Peak	5=Average	* Effective when the source of data is Head A ~ Formula 3 (5~9)	
Pointer clear timing	007Ah	122	1	0=When trigger is ON		1=When RESET is ON					
Pointer end control	007Bh	123	1	0=Stop		1=Continue from start					
Storage transfer start pointer	007Ch	124	0	LOW	Start pointer number (0 ~ 245928) of the internal storage memory for transferring to shared memory. 262144 (14Eh~7FFDh) totally (every 16216). This is effective immediately after updating.						
	007Dh	125		HI							

Following shows about storage function.

Measured data will be stored regarding to related parameters set. You can transfer the data from storage into shared memory after the measurement.

● UQ1 data access for storage

UQ1 has internal memory for storage besides the shared memory.

Measurement data will be stored into the internal memory firstly.

To refer the measurement data, please proceed following procedure.

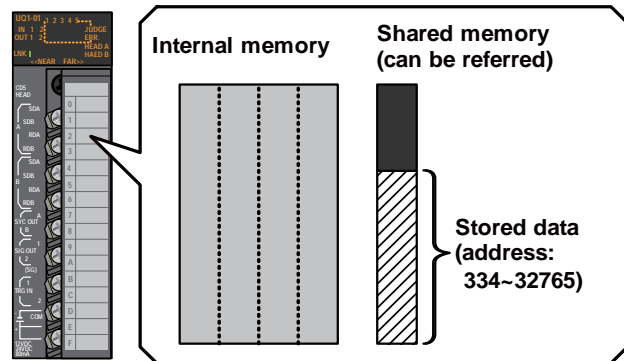

Procedure of getting data transferred to shared memory

1) Storage setup

Setup parameters related to storage of measurement data.

Please refer [1.2.2 UQ1 series data flow] about how to over write shared memory.

2) Getting measurement data from CD5 sensor head into internal memory for storage

UQ1 unit gets the measurement data from CD5 and store into internal memory for storage regarding the setup.

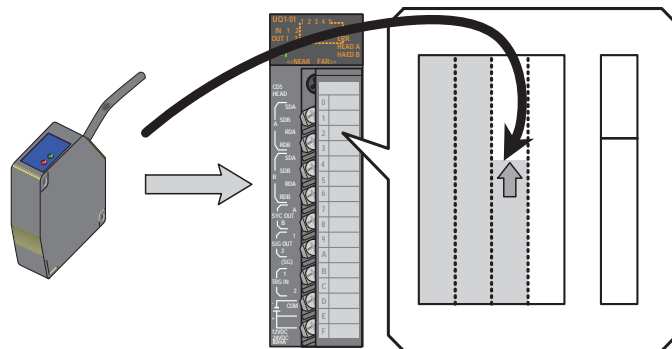

Tips

Maximum number of data can be stored into the internal memory is 262144 (word).

When the pointer of the memory exceeds end of the memory, it proceeds according to "Pointer end control" (shared memory address: 123) setup.

3) Get the data transferred

The measurement data can be referred after transferring the data from the storage memory into shared memory. The start pointer of the storage is specified by "Storage transfer start pointer" (shared memory address: 124~125).

You can check current pointer of the storage at "Storage current pointer" (shared memory address: 328).

* Over writing by Y10 "Over writing common setup" is not needed.

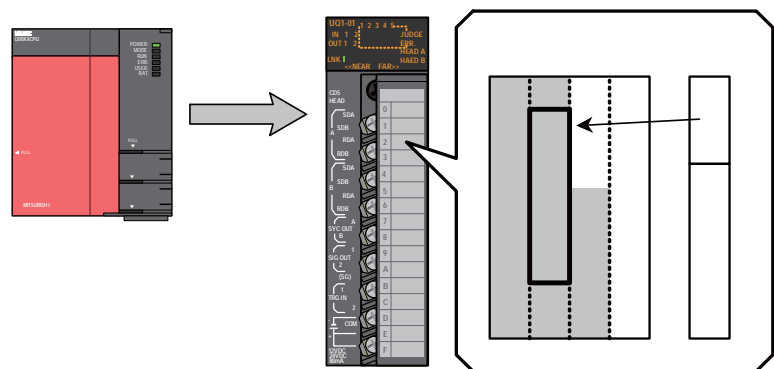

Specify the start pointer

The measurement data will be transferred by setting Y0F "Getting data stored".

While transferring data, X13 "BUSY Getting data stored" will be ON and stop measurement.

After transferring data to shared memory, the data can be referred by sequencer.

You can transfer the data more than 16216 word changing the pointer.

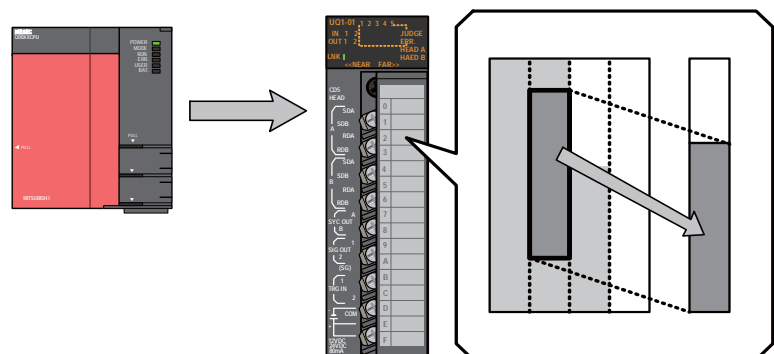

The data will be transferred by setting Y0F "Getting data stored"

● Data store skip number

Specify the number to skip when storing data from CD5 sensor head to the storage memory.

After storing one data, it skips the number of data specified before next storing.

When "0" is set, all the data will be stored.

Example: Store one data while sampling 10 times.

Data store skip number: 9

When UQ1 update period is 100µs: $0.1\text{ms} * 10 = 1\text{ms}$ (store one data every 1ms)

When UQ1 update period is 3200µs: $3.2\text{ms} * 10 = 32\text{ms}$ (store one data every 32ms)

● Source of data

Specify the source of data to store.

When Q1~Q5 is chosen, its offset will be added before storing.

[Parameters]

0: Q1

1: Q2

2: Q3

3: Q4

4: Q5

5: Head A

6: Head B

7: Formula 1

8: Formula 2

9: Formula 3

● Hold mode

Specify the hold mode of the source of data.

Effective when the source of data is Head A/B, Formula 1/2/3 (shared memory address 120 is 5~9).

[Parameters]

0: None

1: Sample

2: Peak

3: Bottom

4: Peak to Peak

5: Average

● Storage of 2 measurement result (UQ1-02)

You can store 2 measurement result with UQ1-02 at a time.

Maximum number of the data is 131071 (1FFFFh) for each measurement result.

Setup as follows.

Item	Address		Parameters			
	Hex.	Decimal	1000h	100h	10h	1h
Source of data	0078h	120	0	(2nd parameter)	1	(1st parameter)
Hold mode	0079h	121	0	(2nd parameter)	0	(1st parameter)

"Storage current pointer" (shared memory 328, 329) shows 1st pointer.

2nd pointer is "Storage current pointer" + 131072 (20000h).

Example: "Source of data": 1st Q2, 2nd Q3 → $1 + 10\text{h}(16) + (2 * 100\text{h}(256)) = 211\text{h}(529)$

Example: "Hold mode": 1st Peak, 2nd Bottom → $2 + (3 * 100\text{h}(256)) = 302\text{h}(770)$

Tips

UQ1-01 later version than 2 support storing 2 measurement result.

You can confirm the version on the label.

There is version number above the "CE" mark.

With no version shown as following picture it's version 1.



If you proceed storing 2 measurement result with UQ1 of version 1, it will store only one measurement result of Q1 with Hold mode: "None".

● Pointer clear timing

Specify the timing to clear the pointer.

- When the Trigger is ON

When the trigger is ON, when storing starts, the pointer is cleared.

- When the RESET is ON

When Y09 "RESET" is ON, the pointer is cleared.

When the trigger is ON, it continues storing new data increasing the pointer.

[Parameters]

0: Trigger is ON

1: RESET is ON

● Pointer end control

Specify the process of the pointer when the pointer reaches end of the storage memory.

[Parameters]

0: Stop (stops storing measurement data)

1: Continue from start (clear the pointer and continue storing the data)

● Storage transfer start pointer

Specify start pointer of storage memory (0~245928) for transferring to shared memory.

It affects immediately right after setting this parameter (no need setting Y10 "Over writing common setup").

Data is stored being numbered from 0.

When the pointer is specified, 16216 data will be transferred to "Loaded data" (shared memory address 14Eh~7FFDh) from the address pointed by the pointer.

0~245928: Storage transfer start pointer

Tips

When set start pointer as bigger than 245928, data over 262144 will be stored from 0.

3.2.7 Initializing

Item	Address		Default	Parameters
	Hex.	Decimal		
Initialize	007Fh	127	0101h	* Initialize by rebooting after setting this parameter "0" and Y10 as "1".

Initialize all setup parameters to default.

Initializing procedure is as follows.

- <1> Set Initialize (shared memory address 127) as "0"
- <2> Activate Y10 Over writing common setup
- <3> After confirming X10 BUSY: Over writing common setup is OFF, shut down the power supply and re-power.

3.2.8 Bank setup

Item	Address		Default	Parameters		
	Hex.	Decimal				
Threshold / Offset	Q1 Upper threshold	0080h	128	47868C0h	LOW	080000000h (-2147483648) ~ 7FFFFFFFh (2147483647) (Offset is reflected)
		0081h	129	(75000000)	HI	
	Q1 Lower threshold	0082h	130	0FB879740h	LOW	080000000h (-2147483648) ~ 7FFFFFFFh (2147483647) (Offset is reflected)
		0083h	131	(-75000000)	HI	
	Q2 Upper threshold	0084h	132	47868C0h	LOW	080000000h (-2147483648) ~ 7FFFFFFFh (2147483647) (Offset is reflected)
		0085h	133	(75000000)	HI	
	Q2 Lower threshold	0086h	134	0FB879740h	LOW	080000000h (-2147483648) ~ 7FFFFFFFh (2147483647) (Offset is reflected)
		0087h	135	(-75000000)	HI	
	Q3 Upper threshold	0088h	136	47868C0h	LOW	080000000h (-2147483648) ~ 7FFFFFFFh (2147483647) (Offset is reflected)
		0089h	137	(75000000)	HI	
	Q3 Lower threshold	008Ah	138	0FB879740h	LOW	080000000h (-2147483648) ~ 7FFFFFFFh (2147483647) (Offset is reflected)
		008Bh	139	(-75000000)	HI	
	Q4 Upper threshold	008Ch	140	47868C0h	LOW	080000000h (-2147483648) ~ 7FFFFFFFh (2147483647) (Offset is reflected)
		008Dh	141	(75000000)	HI	
	Q4 Lower threshold	008Eh	142	0FB879740h	LOW	080000000h (-2147483648) ~ 7FFFFFFFh (2147483647) (Offset is reflected)
		008Fh	143	(-75000000)	HI	
	Q5 Upper threshold	0090h	144	47868C0h	LOW	080000000h (-2147483648) ~ 7FFFFFFFh (2147483647) (Offset is reflected)
		0091h	145	(75000000)	HI	
	Q5 Lower threshold	0092h	146	0FB879740h	LOW	080000000h (-2147483648) ~ 7FFFFFFFh (2147483647) (Offset is reflected)
		0093h	147	(-75000000)	HI	
Q1 Offset	0094h	148	0	LOW	080000000h (-2147483648) ~ 7FFFFFFFh (2147483647)	
	0095h	149		HI		
Q2 Offset	0096h	150	0	LOW	080000000h (-2147483648) ~ 7FFFFFFFh (2147483647)	
	0097h	151		HI		
Q3 Offset	0098h	152	0	LOW	080000000h (-2147483648) ~ 7FFFFFFFh (2147483647)	
	0099h	153		HI		
Q4 Offset	009Ah	154	0	LOW	080000000h (-2147483648) ~ 7FFFFFFFh (2147483647)	
	009Bh	155		HI		
Q5 Offset	009Ch	156	0	LOW	080000000h (-2147483648) ~ 7FFFFFFFh (2147483647)	
	009Dh	157		HI		
Reserved	009Eh	158				
Reserved	009Fh	159				

Setup parameters for each Bank.

● Q1 ~ Q5 Upper threshold, Q1 ~ Q5 Lower threshold

Specify threshold of Q1 ~ Q5.

Judge (OK or NG) will be done for each value including its offset.

● Offset Q1 ~ Q5

Specify offset value for each Q1 ~ Q5.

When Y00 ~ Y04 Zero reset for Q1 ~ Q5 is ON, offset of corresponding Qx will be adjusted so that the Qx to be "0".

3.2.9 Q1 ~ Q5 result

Item	Address		Default	Parameters	
	Hex.	Decimal			
Q1 ~ Q5 result	Q1	00A0h	160	LOW	08000000h (-2147483648) ~ 7FFFFFFFh (2147483647) (Offset is reflected)
		00A1h	161	HI	
	Q2	00A2h	162	LOW	08000000h (-2147483648) ~ 7FFFFFFFh (2147483647) (Offset is reflected)
		00A3h	163	HI	
	Q3	00A4h	164	LOW	08000000h (-2147483648) ~ 7FFFFFFFh (2147483647) (Offset is reflected)
		00A5h	165	HI	
	Q4	00A6h	166	LOW	08000000h (-2147483648) ~ 7FFFFFFFh (2147483647) (Offset is reflected)
		00A7h	167	HI	
	Q5	00A8h	168	LOW	08000000h (-2147483648) ~ 7FFFFFFFh (2147483647) (Offset is reflected)
		00A9h	169	HI	

● Q1 ~ Q5 result

Q1 ~ Q5 will be used for Signal out 1/2.

Q1 ~ Q5 is its source (Head or Formula or Receiving data) + its offset.

Item	Address		Default	Parameters	
	Hex.	Decimal			
Center stand off	Head A Center stand off	00AAh	170	Fixed value by type	LOW 2500000(25mm) ~ 20000000 (2000mm) HI
		00ABh	171		
	Head B Center stand off	00ACh	172	Fixed value by type	LOW 2500000(25mm) ~ 20000000 (2000mm) HI
		00ADh	173		
	Reserved	00AEh	174		
	Reserved	00AFh	175		

● Head A/B Center stand off

Center stand off will be set automatically recognizing connected CD5 sensor type.

This value will be utilized for reference as absolute center stand off.

Example: 85.000mm for CD5-85

Parameters in detail

Item	Address		Default	Parameters	
	Hex.	Decimal			
Head A	00B0h	176	LOW	08000000h (-2147483648) ~ 7FFFFFFFh (2147483647)	
	00B1h	177	HI		
Head A Sample Hold	00B2h	178	LOW	08000000h (-2147483648) ~ 7FFFFFFFh (2147483647)	
	00B3h	179	HI	set by "Pointer clear timing"	
Head A Auto Peak hold	00B4h	180	LOW	08000000h (-2147483648) ~ 7FFFFFFFh (2147483647)	
	00B5h	181	HI	set by "Pointer clear timing"	
Head A Peak Hold	00B6h	182	LOW	08000000h (-2147483648) ~ 7FFFFFFFh (2147483647)	
	00B7h	183	HI	set by "Pointer clear timing"	
Head A Auto Bottom Hold	00B8h	184	LOW	08000000h (-2147483648) ~ 7FFFFFFFh (2147483647)	
	00B9h	185	HI	set by "Pointer clear timing"	
Head A Bottom Hold	00BAh	186	LOW	08000000h (-2147483648) ~ 7FFFFFFFh (2147483647)	
	00BBh	187	HI	set by "Pointer clear timing"	
Head A Auto Peak to Peak Hold	00BCh	188	LOW	0 ~ 7FFFFFFFh (2147483647)	
	00BDh	189	HI	set by "Pointer clear timing"	
Head A Peak to Peak Hold	00BEh	190	LOW	0 ~ 7FFFFFFFh (2147483647)	
	00BFh	191	HI	set by "Pointer clear timing"	
Head A Auto Average Hold	00C0h	192	LOW	08000000h (-2147483648) ~ 7FFFFFFFh (2147483647)	
	00C1h	193	HI	set by "Pointer clear timing"	
Head A Average Hold	00C2h	194	LOW	08000000h (-2147483648) ~ 7FFFFFFFh (2147483647)	
	00C3h	195	HI	set by "Pointer clear timing"	
Head A Count	00C4h	196	LOW	08000000h (-2147483648) ~ 7FFFFFFFh (2147483647)	
	00C5h	197	HI	set by "Pointer clear timing"	
Head B	00C6h	198	LOW	08000000h (-2147483648) ~ 7FFFFFFFh (2147483647)	
	00C7h	199	HI		
Head B Sample Hold	00C8h	200	LOW	08000000h (-2147483648) ~ 7FFFFFFFh (2147483647)	
	00C9h	201	HI	set by "Pointer clear timing"	
Head B Auto Peak hold	00CAh	202	LOW	08000000h (-2147483648) ~ 7FFFFFFFh (2147483647)	
	00CBh	203	HI	set by "Pointer clear timing"	
Head B Peak Hold	00CCh	204	LOW	08000000h (-2147483648) ~ 7FFFFFFFh (2147483647)	
	00CDh	205	HI	set by "Pointer clear timing"	
Head B Auto Bottom Hold	00CEh	206	LOW	08000000h (-2147483648) ~ 7FFFFFFFh (2147483647)	
	00CFh	207	HI	set by "Pointer clear timing"	
Head B Bottom Hold	00D0h	208	LOW	08000000h (-2147483648) ~ 7FFFFFFFh (2147483647)	
	00D1h	209	HI	set by "Pointer clear timing"	
Head B Auto Peak to Peak Hold	00D2h	210	LOW	0 ~ 7FFFFFFFh (2147483647)	
	00D3h	211	HI	set by "Pointer clear timing"	
Head B Peak to Peak Hold	00D4h	212	LOW	0 ~ 7FFFFFFFh (2147483647)	
	00D5h	213	HI	set by "Pointer clear timing"	
Head B Auto Average Hold	00D6h	214	LOW	08000000h (-2147483648) ~ 7FFFFFFFh (2147483647)	
	00D7h	215	HI	set by "Pointer clear timing"	
Head B Average Hold	00D8h	216	LOW	08000000h (-2147483648) ~ 7FFFFFFFh (2147483647)	
	00D9h	217	HI	set by "Pointer clear timing"	
Head B Count	00DAh	218	LOW	08000000h (-2147483648) ~ 7FFFFFFFh (2147483647)	
	00DBh	219	HI	set by "Pointer clear timing"	
Formula 1	00DCh	220	LOW	08000000h (-2147483648) ~ 7FFFFFFFh (2147483647)	
	00Ddh	221	HI		
Formula 1 Sample Hold	00DEh	222	LOW	08000000h (-2147483648) ~ 7FFFFFFFh (2147483647)	
	00DFh	223	HI	set by "Pointer clear timing"	
Formula 1 Auto Peak Hold	00E0h	224	LOW	08000000h (-2147483648) ~ 7FFFFFFFh (2147483647)	
	00E1h	225	HI	set by "Pointer clear timing"	
Formula 1 Peak Hold	00E2h	226	LOW	08000000h (-2147483648) ~ 7FFFFFFFh (2147483647)	
	00E3h	227	HI	set by "Pointer clear timing"	
Formula 1 Auto Bottom Hold	00E4h	228	LOW	08000000h (-2147483648) ~ 7FFFFFFFh (2147483647)	
	00E5h	229	HI	set by "Pointer clear timing"	
Formula 1 Bottom Hold	00E6h	230	LOW	08000000h (-2147483648) ~ 7FFFFFFFh (2147483647)	
	00E7h	231	HI	set by "Pointer clear timing"	
Formula 1 Auto Peak to Peak Hold	00E8h	232	LOW	0 ~ 7FFFFFFFh (2147483647)	
	00E9h	233	HI	set by "Pointer clear timing"	
Formula 1 Peak to Peak Hold	00EAh	234	LOW	0 ~ 7FFFFFFFh (2147483647)	
	00EBh	235	HI	set by "Pointer clear timing"	
Formula 1 Auto Average Hold	00ECh	236	LOW	08000000h (-2147483648) ~ 7FFFFFFFh (2147483647)	
	00EDh	237	HI	set by "Pointer clear timing"	
Formula 1 Average Hold	00EEh	238	LOW	08000000h (-2147483648) ~ 7FFFFFFFh (2147483647)	
	00EFh	239	HI	set by "Pointer clear timing"	
Formula 1 Count	00F0h	240	LOW	08000000h (-2147483648) ~ 7FFFFFFFh (2147483647)	
	00F1h	241	HI	set by "Pointer clear timing"	
Formula 2	00F2h	242	LOW	08000000h (-2147483648) ~ 7FFFFFFFh (2147483647)	
	00F3h	243	HI		
Formula 2 Sample Hold	00F4h	244	LOW	08000000h (-2147483648) ~ 7FFFFFFFh (2147483647)	
	00F5h	245	HI	set by "Pointer clear timing"	
Formula 2 Auto Peak Hold	00F6h	246	LOW	08000000h (-2147483648) ~ 7FFFFFFFh (2147483647)	
	00F7h	247	HI	set by "Pointer clear timing"	
Formula 2 Peak Hold	00F8h	248	LOW	08000000h (-2147483648) ~ 7FFFFFFFh (2147483647)	
	00F9h	249	HI	set by "Pointer clear timing"	
Formula 2 Auto Bottom Hold	00FAh	250	LOW	08000000h (-2147483648) ~ 7FFFFFFFh (2147483647)	
	00FBh	251	HI	set by "Pointer clear timing"	
Formula 2 Bottom Hold	00FCh	252	LOW	08000000h (-2147483648) ~ 7FFFFFFFh (2147483647)	
	00FDh	253	HI	set by "Pointer clear timing"	
Formula 2 Auto Peak to Peak Hold	00FEh	254	LOW	0 ~ 7FFFFFFFh (2147483647)	
	00FFh	255	HI	set by "Pointer clear timing"	

Item	Address		Default	Parameters					
	Hex.	Decimal							
Formula 2 Peak to Peak Hold	0100h	256	LOW	0 ~ 7FFFFFFFh (2147483647)					
	0101h	257	HI	set by "Pointer clear timing"					
Formula 2 Auto Average Hold	0102h	258	LOW	080000000h (-2147483648) ~ 7FFFFFFFh (2147483647)					
	0103h	259	HI	set by "Pointer clear timing"					
Formula 2 Average Hold	0104h	260	LOW	080000000h (-2147483648) ~ 7FFFFFFFh (2147483647)					
	0105h	261	HI	set by "Pointer clear timing"					
Formula 2 Count	0106h	262	LOW	080000000h (-2147483648) ~ 7FFFFFFFh (2147483647)					
	0107h	263	HI	set by "Pointer clear timing"					
Formula 3	0108h	264	LOW	080000000h (-2147483648) ~ 7FFFFFFFh (2147483647)					
	0109h	265	HI						
Formula 3 Sample Hold	010Ah	266	LOW	080000000h (-2147483648) ~ 7FFFFFFFh (2147483647)					
	010Bh	267	HI	set by "Pointer clear timing"					
Formula 3 Auto Peak Hold	010Ch	268	LOW	080000000h (-2147483648) ~ 7FFFFFFFh (2147483647)					
	010Dh	269	HI	set by "Pointer clear timing"					
Formula 3 Peak Hold	010Eh	270	LOW	080000000h (-2147483648) ~ 7FFFFFFFh (2147483647)					
	010Fh	271	HI	set by "Pointer clear timing"					
Formula 3 Auto Bottom Hold	0110h	272	LOW	080000000h (-2147483648) ~ 7FFFFFFFh (2147483647)					
	0111h	273	HI	set by "Pointer clear timing"					
Formula 3 Bottom Hold	0112h	274	LOW	080000000h (-2147483648) ~ 7FFFFFFFh (2147483647)					
	0113h	275	HI	set by "Pointer clear timing"					
Formula 3 Auto Peak to Peak Hold	0114h	276	LOW	0 ~ 7FFFFFFFh (2147483647)					
	0115h	277	HI	set by "Pointer clear timing"					
Formula 3 Peak to Peak Hold	0116h	278	LOW	0 ~ 7FFFFFFFh (2147483647)					
	0117h	279	HI	set by "Pointer clear timing"					
Formula 3 Auto Average Hold	0118h	280	LOW	080000000h (-2147483648) ~ 7FFFFFFFh (2147483647)					
	0119h	281	HI	set by "Pointer clear timing"					
Formula 3 Average Hold	011Ah	282	LOW	080000000h (-2147483648) ~ 7FFFFFFFh (2147483647)					
	011Bh	283	HI	set by "Pointer clear timing"					
Formula 3 Count	011Ch	284	LOW	080000000h (-2147483648) ~ 7FFFFFFFh (2147483647)					
	011Dh	285	HI	set by "Pointer clear timing"					
Receiving data 1	011Eh	286	LOW	080000000h (-2147483648) ~ 7FFFFFFFh (2147483647)					
	011Fh	287	HI						
Receiving data 2	0120h	288	LOW	080000000h (-2147483648) ~ 7FFFFFFFh (2147483647)					
	0121h	289	HI						
Reserved	0122h	290							
Reserved	0123h	291							
Reserved	0124h	292							
Reserved	0125h	293							
Reserved	0126h	294							
Reserved	0127h	295							

● Measurement result

Measurement result will be set.

Measurement result is updated every updating period of UQ1 regardless of setup of Q1 ~ Q5.

Its process while the trigger is OFF depends on setup of "Hold mode" (shared memory address 103).

When Y09 RESET is ON, the value will be reset.

-0 (Auto mode): When the trigger is OFF, the value will be reset

-1 (Hold mode): The value won't be reset when the trigger is OFF

Tips

Offset value won't be added on the measurement result.

The data from the slave UQ1 unit through FlrST will be set to "Receiving data". Please refer [2.1.1 FlrST communication].

Tips

- The receiving data to be set at slave side unit.
- When the communication data is not available or the data is broken, "0" will be set.
- When "High speed mode" (shared memory address 31) is ON, "Average" and "Average Hold" will be set "0".

Parameters in detail

Item	Address		Default	Parameters									
	Hex.	Decimal											
Element of Formula	Element 1 of Formula 1	0128h	296	LOW	080000000h (-2147483648) ~ 7FFFFFFFh (2147483647)								
		0129h	297	HI									
	Element 2 of Formula 1	012Ah	298	LOW	080000000h (-2147483648) ~ 7FFFFFFFh (2147483647)								
		012Bh	299	HI									
	Element 3 of Formula 1	012Ch	300	LOW	080000000h (-2147483648) ~ 7FFFFFFFh (2147483647)								
		012Dh	301	HI									
	Element 1 of Formula 2	012Eh	302	LOW	080000000h (-2147483648) ~ 7FFFFFFFh (2147483647)								
		012Fh	303	HI									
	Element 2 of Formula 2	0130h	304	LOW	080000000h (-2147483648) ~ 7FFFFFFFh (2147483647)								
		0131h	305	HI									
	Element 3 of Formula 2	0132h	306	LOW	080000000h (-2147483648) ~ 7FFFFFFFh (2147483647)								
		0133h	307	HI									
	Element 1 of Formula 3	0134h	308	LOW	080000000h (-2147483648) ~ 7FFFFFFFh (2147483647)								
		0135h	309	HI									
	Element 2 of Formula 3	0136h	310	LOW	080000000h (-2147483648) ~ 7FFFFFFFh (2147483647)								
		0137h	311	HI									
	Element 3 of Formula 3	0138h	312	LOW	080000000h (-2147483648) ~ 7FFFFFFFh (2147483647)								
		0139h	313	HI									
	Reserved	013Ah	314										
Reserved	013Bh	315											
Reserved	013Ch	316											
Reserved	013Dh	317											
Reserved	013Eh	318											
Reserved	013Fh	319											

● Calculation element

Result of each formula element will be set.

Element 1 ~ 3 are calculation result of formula element as follows.

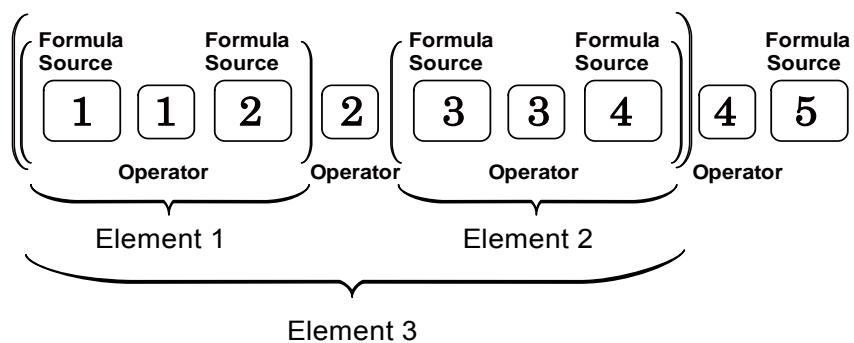

3.2.10 Error status

Item		Address		Default	Parameters								
		Hex.	Decimal										
Calculation Overflow	Formula 1	0140h	320	0	B0= Element 1	B1= Element 2	B2= Element 3	B3= Formula 1					
	Formula 2				B4= Element 1	B5= Element 2	B6= Element 3	B7= Formula 2					
	Formula 3				B8= Element 1	B9= Element 2	B10= Element 3	B11= Formula 3					
	Head A				B12= Out of range Alarm								
	Head B				B13= Out of range Alarm								
Reserve		0141h	321										
Reserve		0142h	322										
Reserve		0143h	323										

● Calculation Overflow

When the calculation result overflows, the corresponding bit will be “1”.

These bits won't be cleared even the overflow is released.

Please proceed one of following procedures to clear the bits.

- Reboot the power supply
- Set Y09 RESET ON
- Set Y16 Error release ON

B0: Element 1 of Formula 1

B1: Element 2 of Formula 1

B2: Element 3 of Formula 1

B3: Formula 1

B4: Element 1 of Formula 2

B5: Element 2 of Formula 2

B6: Element 3 of Formula 2

B7: Formula 2

B8: Element 1 of Formula 3

B9: Element 2 of Formula 3

B10: Element 3 of Formula 3

B11: Formula 3

B12: Head A is out of range

B13: Head B is out of range

3.2.11 Unit status

Item	Address		Default	Parameters						
	Hex.	Decimal								
Current Bank number	0144h	324	0	0 ~ 59 = Bank 0 ~ 59						
Version	0145h	325		Version						
Q1~Q5 and source status	0146h	326	0	B0= Head A	B1= Head B	B2=Formula 1	B3=Formula 2	B4=Formula 3	B5= Receiving data 1	B6= Receiving data 2
				B11=Q1	B12=Q2	B13=Q3	B14=Q4	B15=Q5		
Response speed (μs)	0147h	327								
Storage current pointer	0148h	328	0	LOW	0 ~ 262143 (When the pointer reaches end and "Pointer end control" is 0=Stop, it will stop at 262143. When "Pointer end control" is 1= Continue from start, it restarts from 0.)					
	0149h	329		HI						
Storage overflow	014Ah	330	0	0= Pointer is less than 262143		1= Overflow				
Reserved	014Bh	331								
Reserved	014Ch	332								
Reserved	014Dh	333								

Shows if these resources are used or not.

● Current Bank number

Shows the number of the Bank currently set.

● Version

Shows unit version.

● Q1 ~ Q5 and source status

Shows which Qx and its source are used on each bit.

- B0: Head A
- B1: Head B
- B2: Formula 1
- B3: Formula 2
- B4: Formula 3
- B5: Receiving data 1
- B6: Receiving data 2

When these are assigned at Q1 ~ Q5, the bit will be ON.

- B11: Q1
- B12: Q2
- B13: Q3
- B14: Q4
- B15: Q5

● Response speed

Shows response speed of UQ1 unit in μs.

Updating data in the UQ1 unit will be done every 100μs that rounded out the hundred's place of actual process time. For example, when the actual process time is 140 μs, it's 200μs.

- When updating time of UQ1 > Sampling period of CD5:

UQ1 acquires data every its updating period so it won't be able to acquire every data.

Example) Updating period of UQ1: 400μs, Sampling period of CD5: 200μs;

UQ1 will skip acquisition of data every 2.

- When updating time of UQ1 < Sampling period of CD5:

There will be no updated data from CD5/CD33 intermittently.

When there is no updated data from CD5/CD33, UQ1 unit will use previous data internally.

Tips

You can shorten process time by following setup.

- Not use Formula

The more Formula are used, the longer process time it will spend.

You can shorten process time by deleting Formula that are not needed.

- Not use operator "*" and "÷".

These operators will take time to calculate.

You can shorten process time by not using these operator.

- Use "High speed mode"

You can shorten process time by set "High speed mode" shared memory address 31 ON.

In this case, you can't use "Average Hold" and "Auto Average Hold".

Storage current pointer

Shows current pointer of storage

0 ~ 262143 : Current pointer

(When the pointer reaches end and "Pointer end control" is 0=Stop, it will stop at 262143. When "Pointer end control" is 1= Continue from start, it restarts from 0.)

● Storage overflow

This is a flag that shows if overflow occurred or not in storage.

3.2.12 Loaded data

Item		Address		Default	Parameters	
		Hex.	Decimal			
1st	Depends on "Source of data" address 120	014Eh	334		LOW	Depends on "Source of data" address 120
		014Fh	335		HI	
~	~	~	~			
16199th	Depends on "Source of data" address 120	7FFCh	32766		LOW	Depends on "Source of data" address 120
		7FFDh	32767		HI	

The data will be loaded from storage.

Please refer [3.2.6 Storage setup] for in detail.

3.2.13 Waveform data

When Y14, Y15 Head A/B Waveform mode is ON, shared memory address 334 ~ 1357 will be updated with Waveform data continuously.

Item		Address		Default	Parameters
		Hex.	Decimal		
Waveform data	Head A	Threshold level	014Eh	334	0 ~ 255 (0FFh): UQ1-01 0 ~ 4095 (0FFFh): UQ1-02 65535 (0FFFFh): UQ1-02 (non applicable sensor head)
		Peak position 1	014Fh	335	0 ~ 511 (01FFh)
		Peak position 2	0150h	336	0 ~ 511 (01FFh)
		Waveform data 1	0151h	337	0 ~ 255 (0FFh)
		~	~		
		Waveform data 480 (UQ1-01 end of data)	0331h	817	0 ~ 255 (0FFh)
		Waveform data 508 (UQ1-02 end of data)	034Dh	845	0 ~ 4095 (0FFFh)
	Head B	Threshold level	034Eh	846	0 ~ 255 (0FFh): UQ1-01 0 ~ 4095 (0FFFh): UQ1-02 65535 (0FFFFh): UQ1-02 (non applicable sensor head)
		Peak position 1	034Fh	847	0 ~ 511 (01FFh)
		Peak position 2	0350h	848	0 ~ 511 (01FFh)
		Waveform data 1	0351h	849	0 ~ 255 (0FFh)
		~	~		
		Waveform data 480 (UQ1-01 end of data)	0531h	1329	0 ~ 255 (0FFh)
		Waveform data 508 (UQ1-02 end of data)	054Dh	1357	0 ~ 4095 (0FFFh)

● Threshold

Shows threshold level to detect peak from Waveform data. The level depends on “Threshold for detecting peak” shared memory address 4, 18.

● Peak position 1 / 2

Shows peak position of the Waveform data in CD5 sensor head.

● Waveform data

Shows Waveform data.

Following graph shows Waveform data visually. The position “0” means it’s near side of the sensor head. Maximum light level of UQ1-02 is 4095 though, it will be less than 2047 normally.

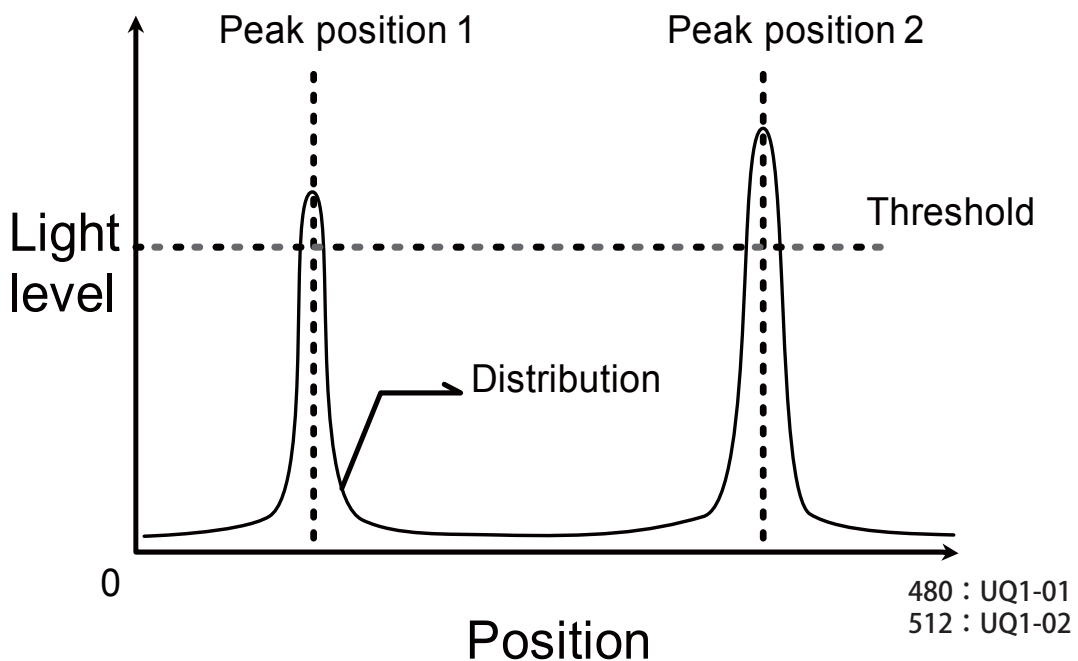

● Timing chart while Waveform mode

X/Y devices regarding "Head A/B monitoring mode" are as following timing chart while switching the mode.
Please don't change Y14/15 "Head A/B Waveform mode" while X14/15 "BUSY" is ON.

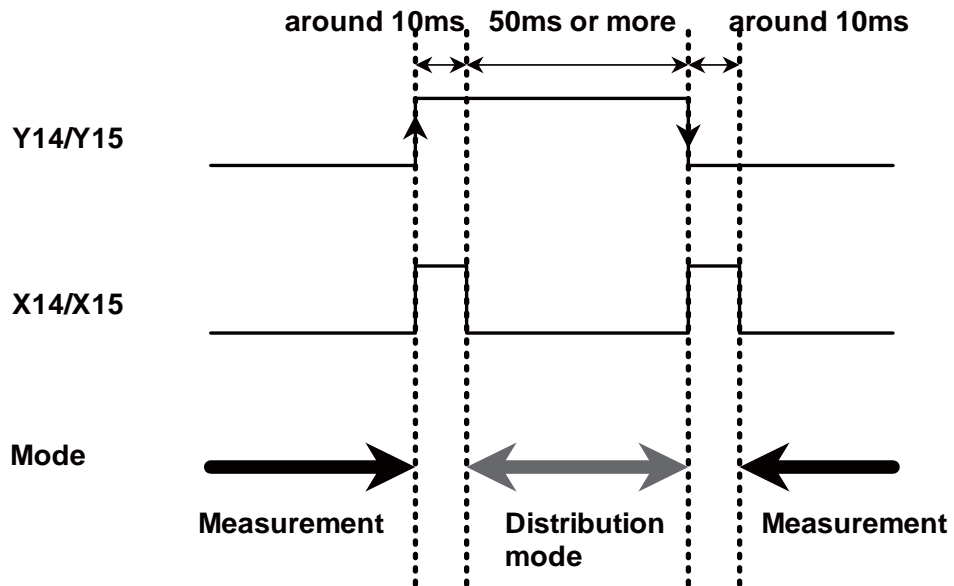

3.3 Hold mode and process

Sampling process of UQ1 will be determined by “Q1 ~ Q5 Hold” and “Hold mode”.

Following time charts show how each mode works.

Parameters not specified in each hold mode explanation are as follows.

- Trigger timing of data sampling: 0 (OFF)
- ON delay / OFF delay / One shot: None
- Signal Out logic: 0 (normal)

Tips

- Trigger for Head A/B and Calculation 1/2/3 is made by Trigger IN (terminal input) or Y0A ~ Y0E.
- Trigger input assignment is specified by "Trigger IN 1/2" (shared memory address 117/118).

● No Hold

- Qx Hold: 0 (No Hold)
- Hold mode: 0/1 (doesn't affect)

It doesn't do Hold process. While Trigger input is ON, it keeps the level at just before the Trigger input is ON.

Dotted line means original measured value. Full line means output.

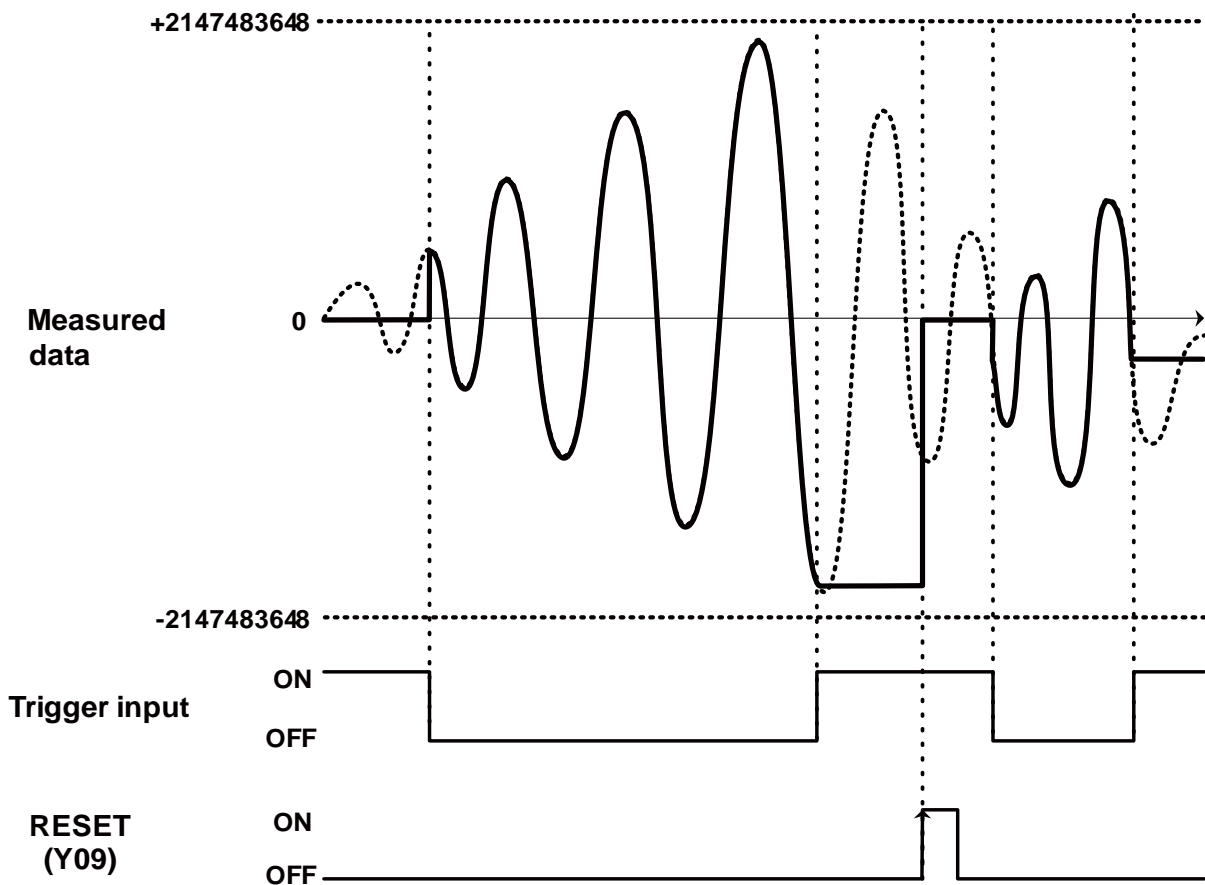

● Sample Hold

- Qx Hold: 1 (Sample Hold)
- Hold mode: 0/1 (doesn't affect)

It samples and hold at up edge of Trigger input. Effective for sampling the level at a point.

Dotted line means original measured value. Full line means output.

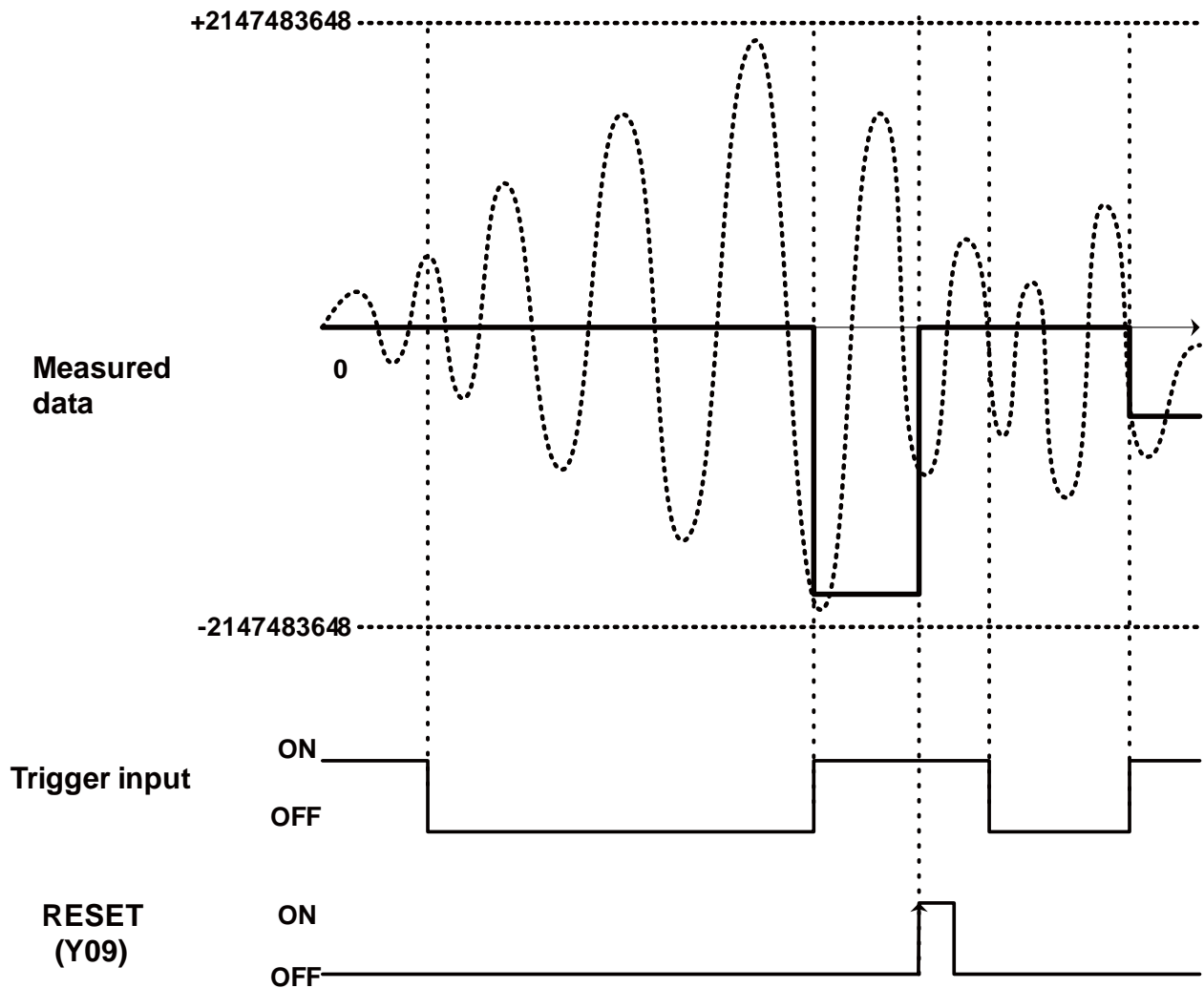

● Peak Hold

- Qx Hold: 2 (Peak Hold)
- Qx Hold: 2 (Peak Hold)

It outputs maximum level sampled while the sampling period.

Dotted line means original measured value. Full line means output.

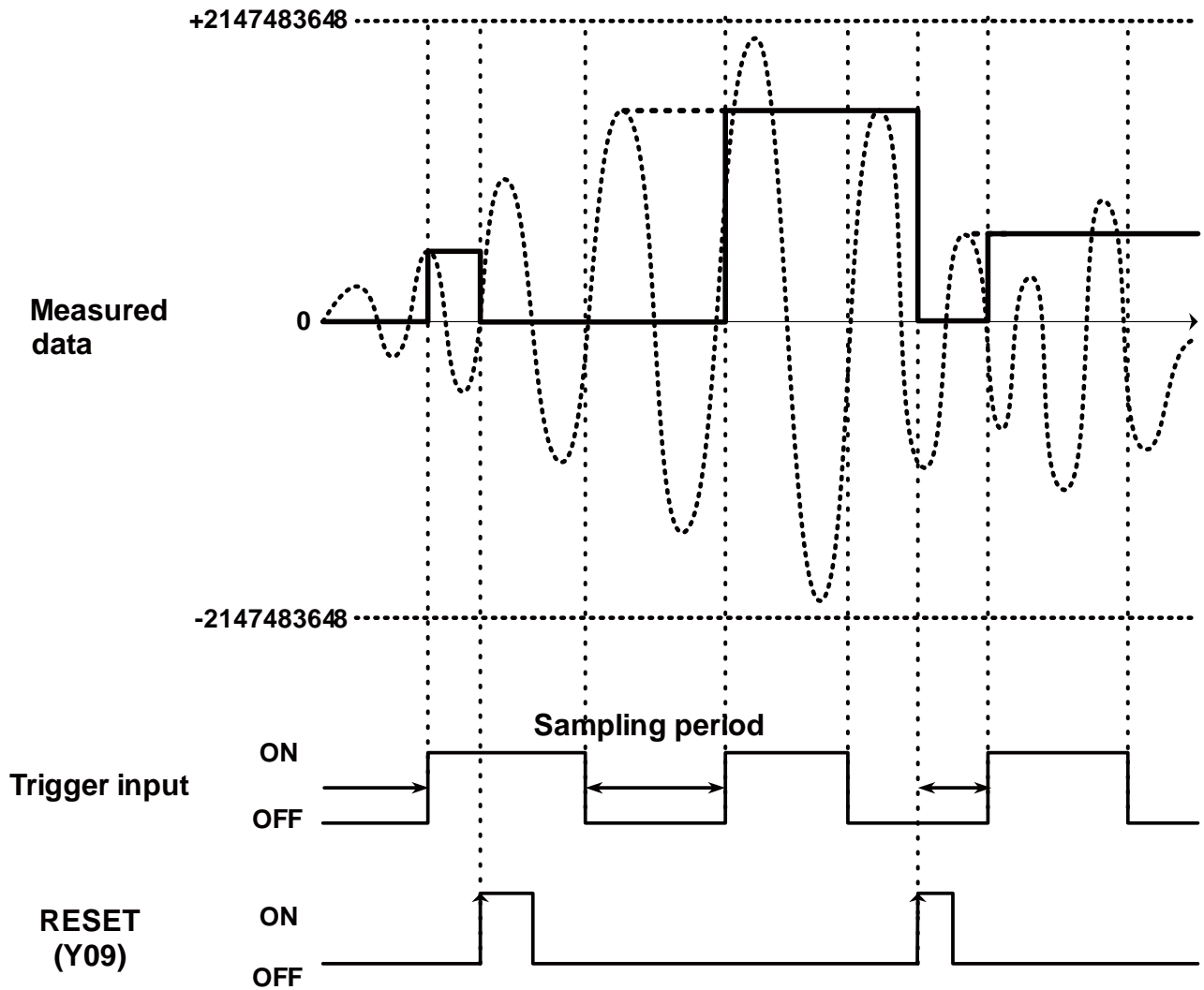

● Auto Peak Hold

- Qx Hold: 2 (Peak Hold)
- Hold mode: 0 (Auto)

While the Trigger input is OFF, it outputs and keeps maximum level.

While the Trigger input is ON, it keeps the level sampled at up edge of the trigger input.

Dotted line means original measured value. Full line means output.

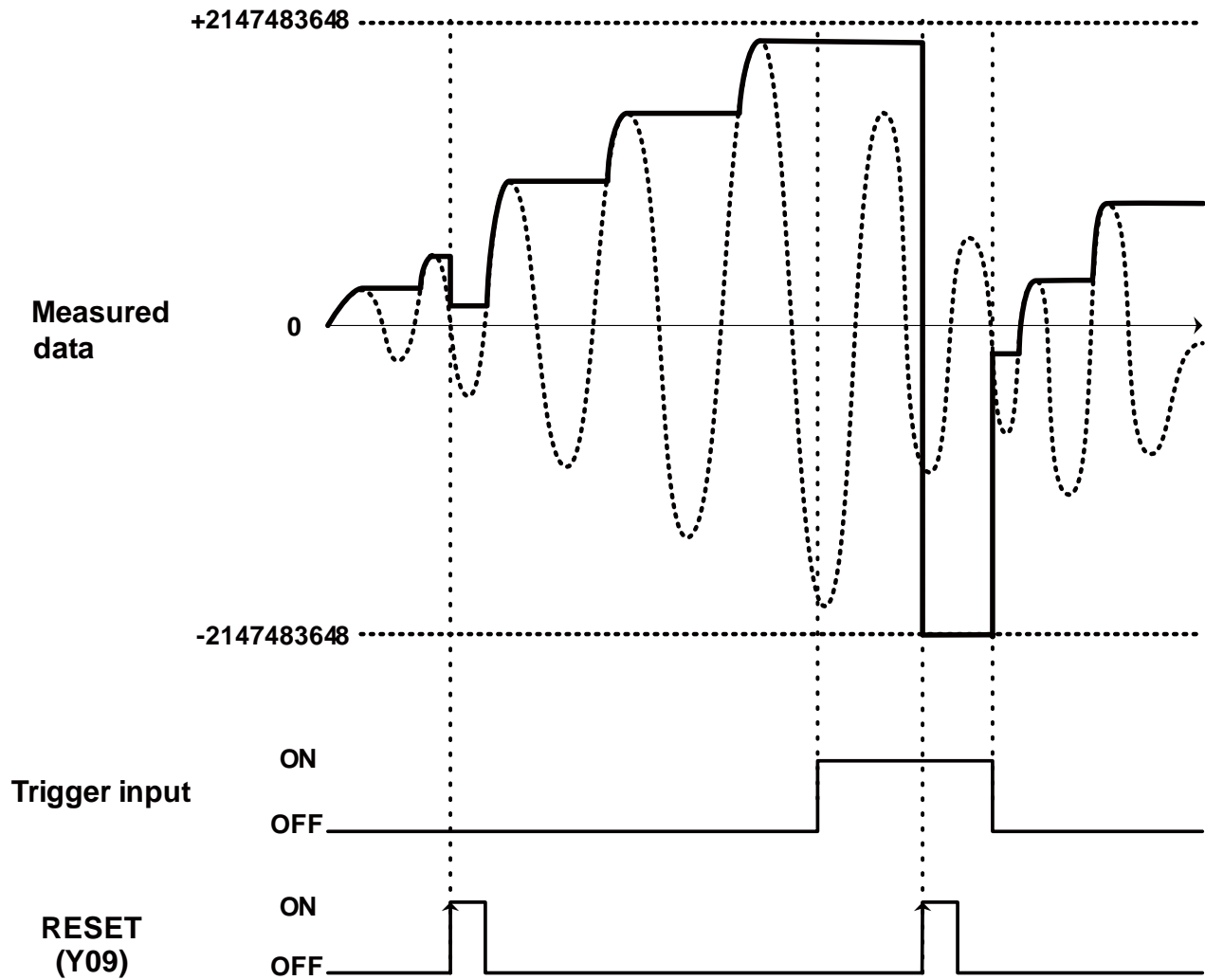

● Bottom Hold

- Qx Hold: 3 (Bottom Hold)
- Hold mode: 1 (Normal)

It outputs minimum level sampled while the sampling period.

Dotted line means original measured value. Full line means output.

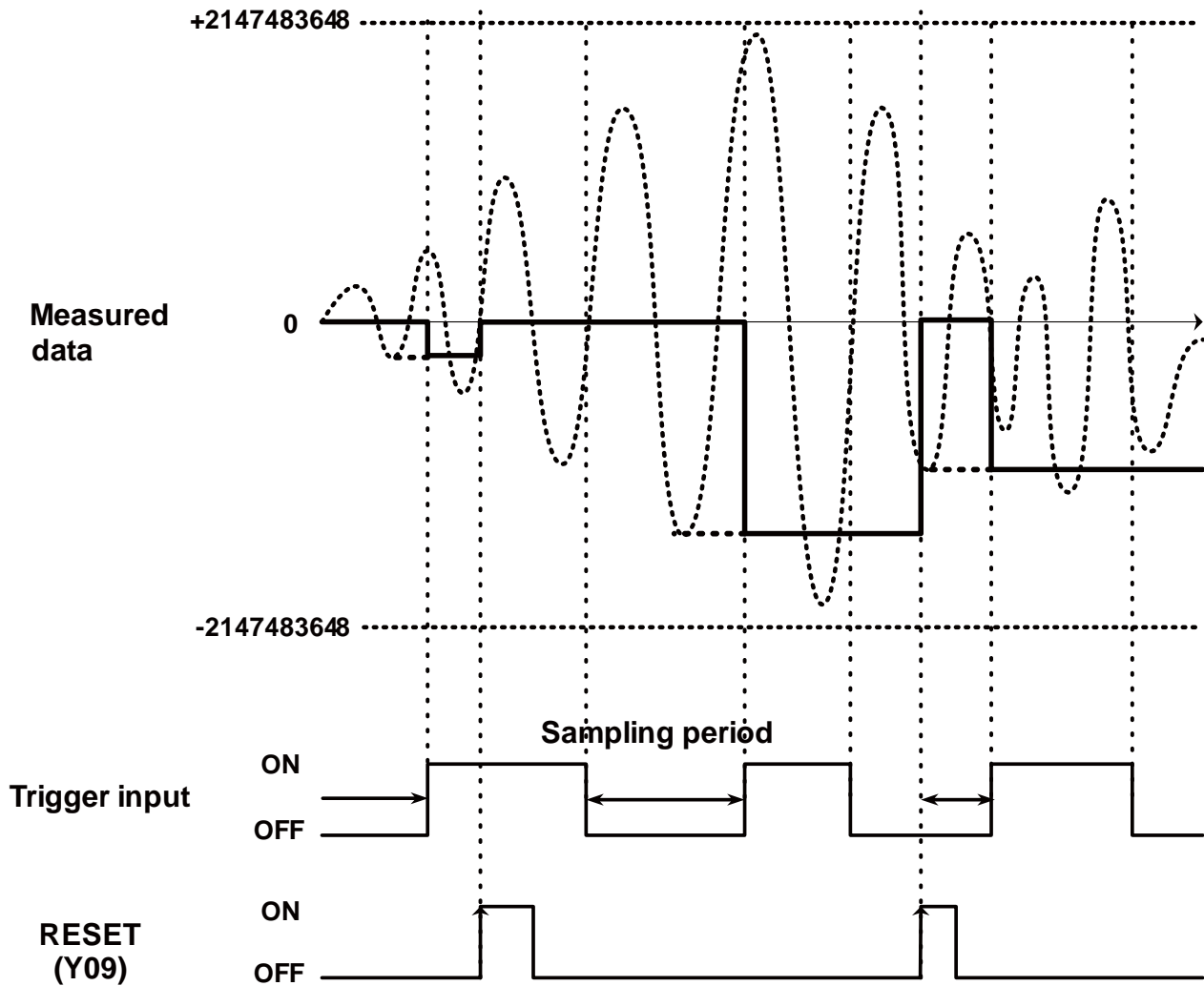

● Auto Bottom Hold

- Qx Hold: 3 (Bottom Hold)
- Hold mode: 0 (Auto)

While the Trigger input is OFF, it outputs and keeps minimum level.

While the Trigger input is ON, it keeps the level sampled at up edge of the trigger input.

Dotted line means original measured value. Full line means output.

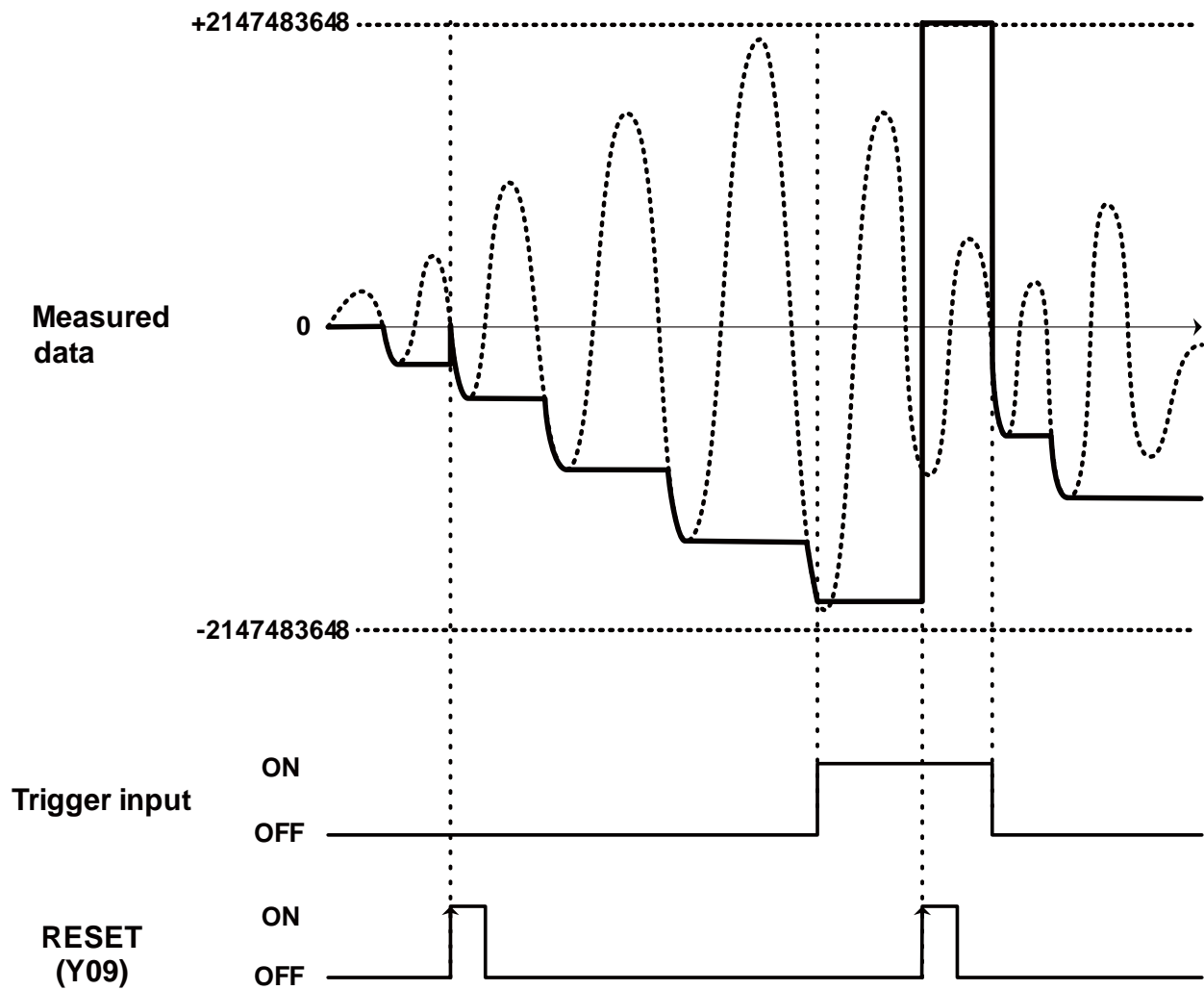

● Peak to Peak Hold

- Qx Hold: 4 (Peak to Peak Hold)
- Hold mode: 1 (Normal)

It outputs peak to peak (maximum - minimum) level sampled while the sampling period.

Dotted line means original measured value. Full line means output.

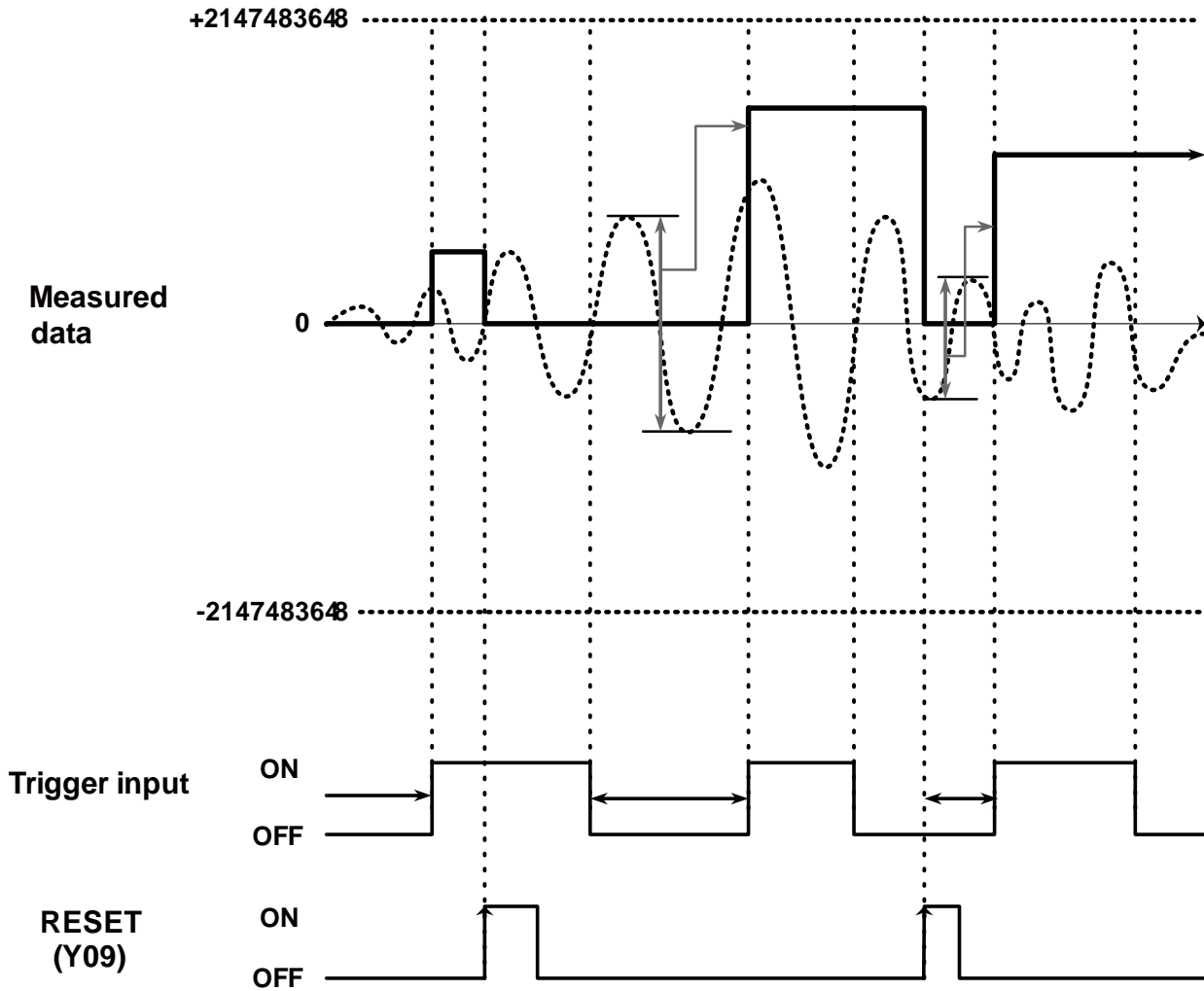

● Auto Peak to Peak Hold

- Qx Hold: 4 (Peak to Peak Hold)
- Hold mode: 0 (Auto)

While the Trigger input is OFF, it outputs and keeps peak to peak (maximum - minimum) level.
 While the Trigger input is ON, it keeps the level sampled at up edge of the trigger input.

Dotted line means original measured value. Full line means output.

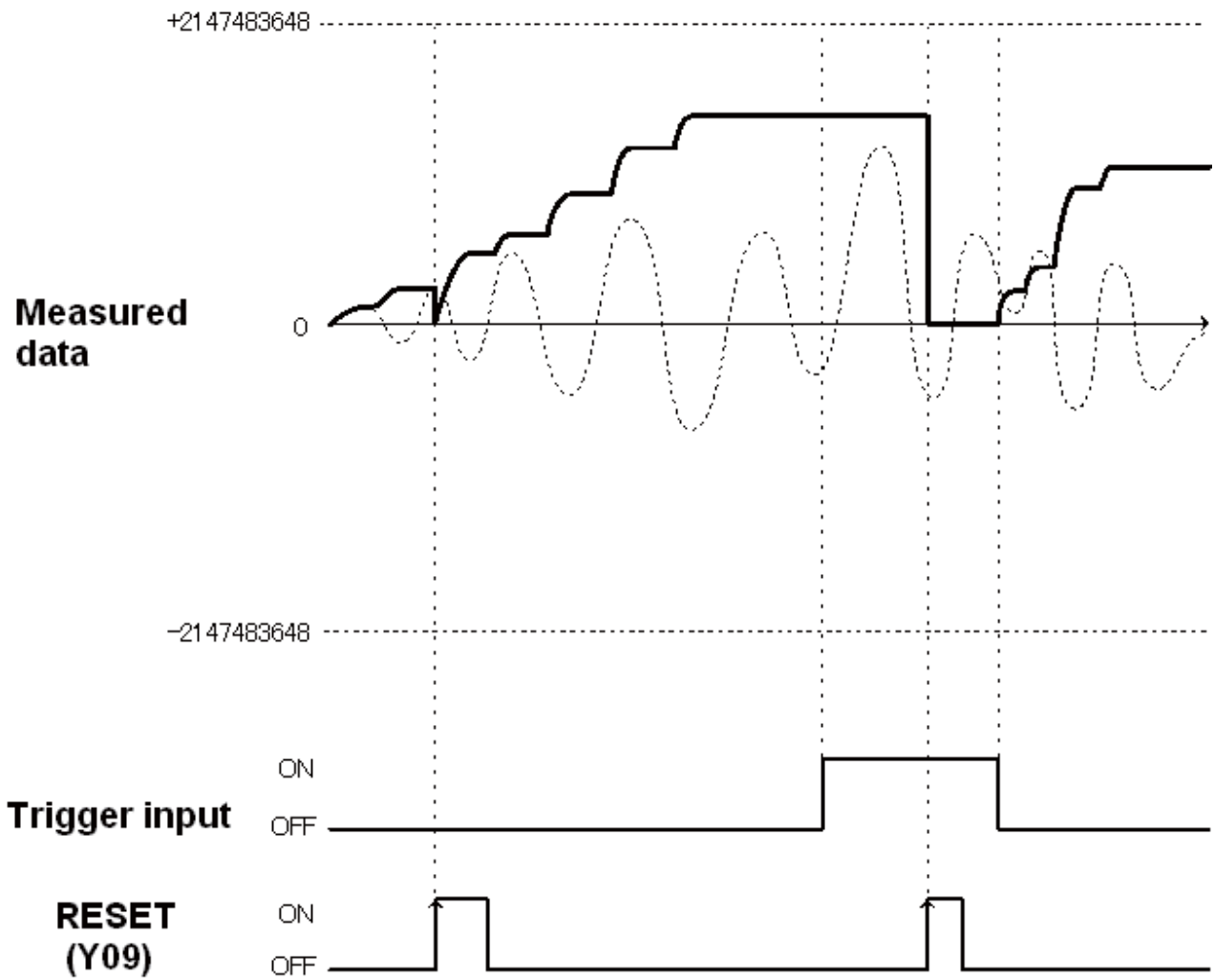

● Average Hold

- Qx Hold: 5 (Average Hold)
- Hold mode: 1 (Normal)

It outputs average level sampled while the sampling period.

Dotted line means original measured value. Full line means output.

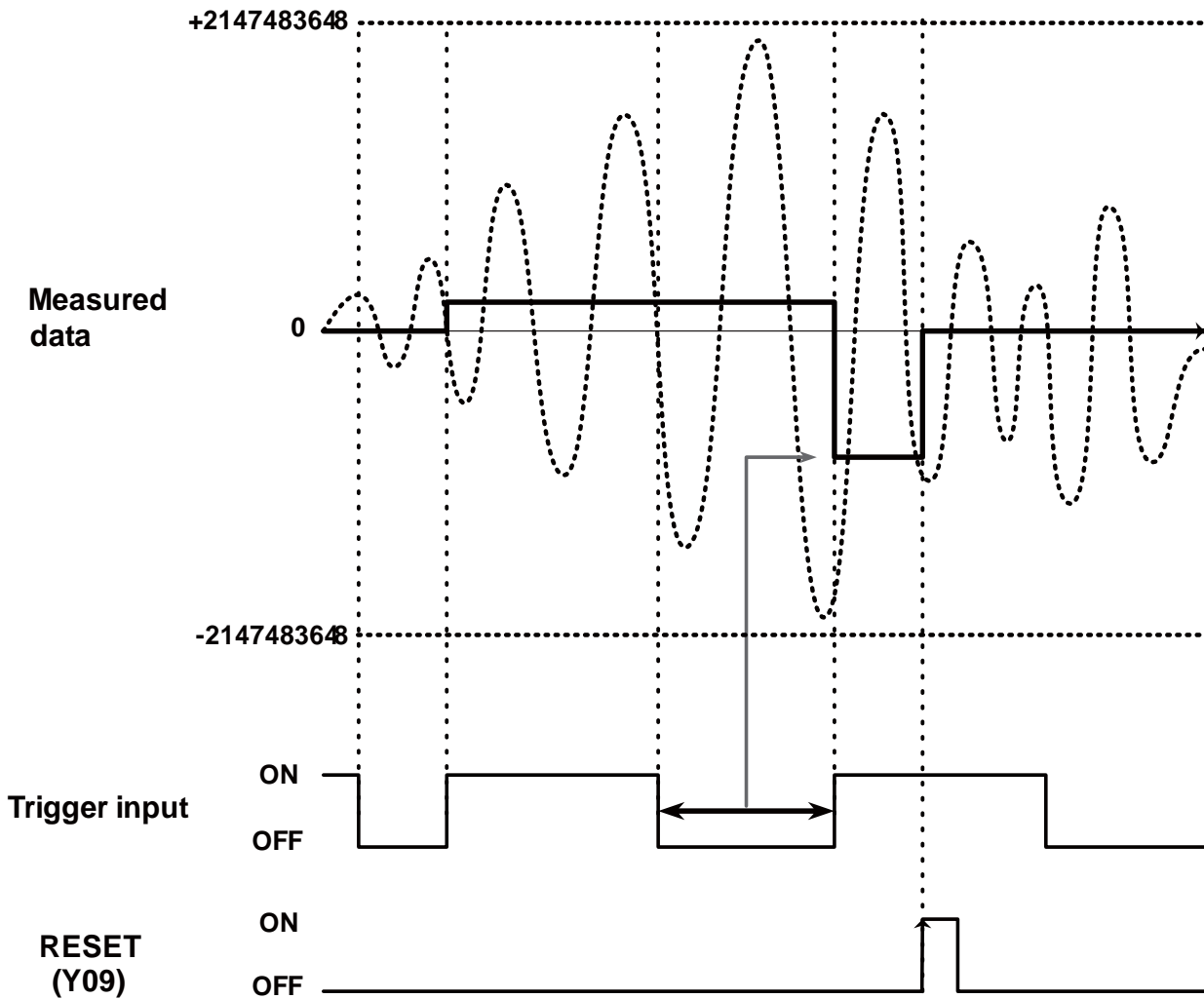

Tips

When "High speed mode" is ON, the data won't be updated.

● Auto Average Hold

- Qx Hold: 5 (Average Hold)
- Hold mode: 0 (Auto)

While the Trigger input is OFF, it outputs and keeps average level.

While the Trigger input is ON, it keeps the level sampled at up edge of the trigger input.

Dotted line means original measured value. Full line means output.

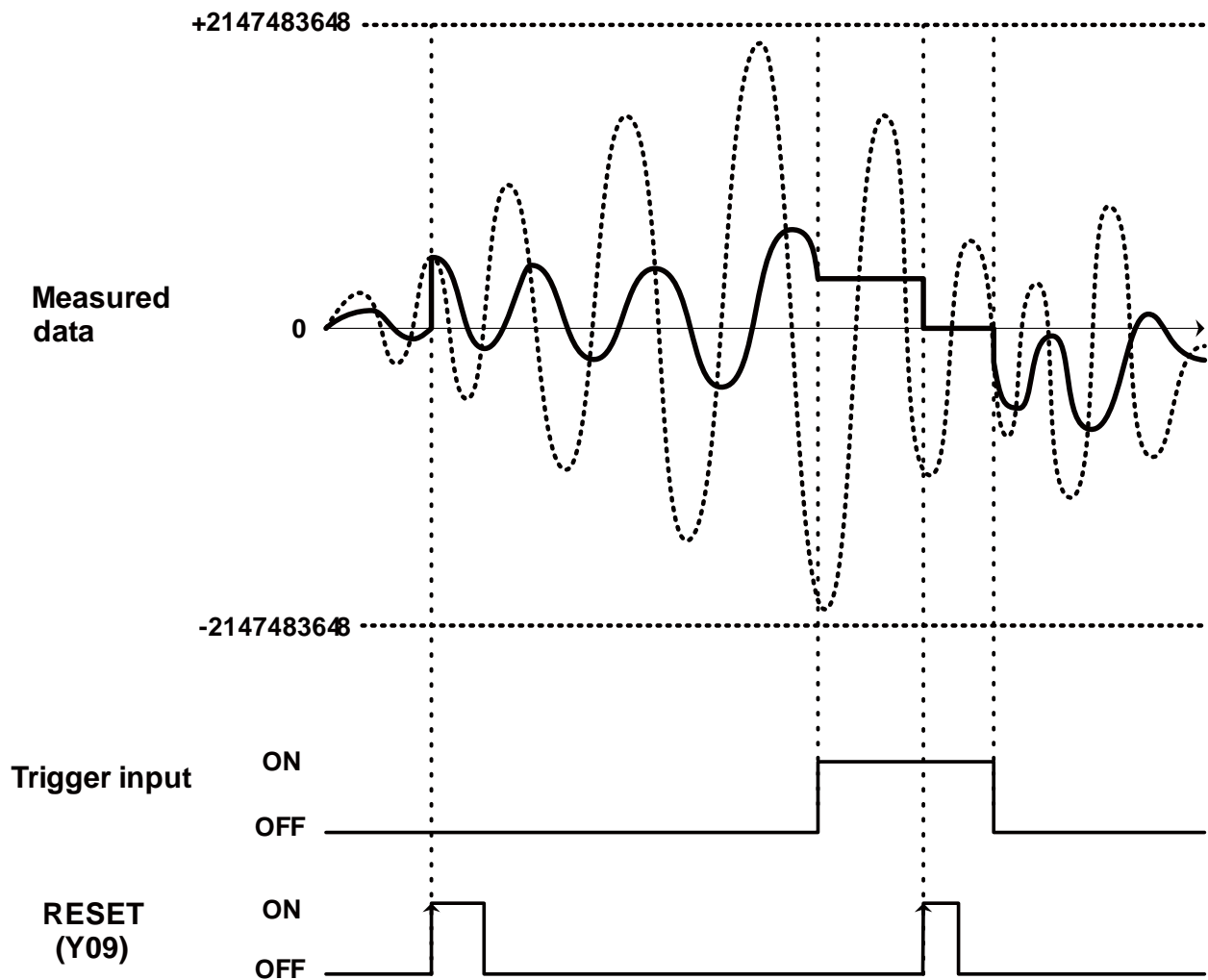

Tips

When "High speed mode" is ON, the data won't be updated.

4

Setup software

4.1 Setup software general description

4.1.1 Recommended system requirements

Please make sure that your system meets following requirements.

Item	Requirements
PC to run the software	Windows based PC
OS *1	Microsoft Windows XP Microsoft Windows Vista Microsoft Windows 7
Main memory	512MB Minimum
HDD	100MB Minimum
I/O port	USB / Ethernet *2 / RS-232C *3 QBUS (MELSEC QCPU I/F)
Number of available unit	4 units

*1: You can't use 64 bit Windows.

*2: It doesn't work with MELSEC Q series Ethernet unit QJ71E71-100.

*3: It doesn't work with MELSEC Q series serial communication unit QJ71C24N/-R2/-R4.

4.1.2 Software general description

This software is configured as follows.

Item	Description	Reference
Setup screen	---	---
Set destination	Choose I/F (USB / Ethernet / RS-232C) between MELSEC CPU.	4.4.1
Unit setup	Setup slot number and First I/O number of the unit. You can add/delete the unit and copy setup. It can readout setup information from all UQ1 units connecting to MELSEC CPU.	4.5.1
Calculation setup	Setup formula for the calculation in UQ1 unit. You can input the formula directly and also you can choose the formula according to the application e.g. thickness, step.	4.5.3 4.5.4
Sensor head setup	Setup parameters of the sensor e.g. measurement target, laser power.	4.5.5
Calibration setup	Set "Shift" and "Span" that cancel the deviation of the sensor head mounted. You can input directly and you can also adjust with two point measured value.	4.5.6
I/O setup	Setup parameters regarding to Input/Output.	4.5.7
Control output setup	Setup Upper/Lower threshold to evaluate measured value in UQ1 unit.	4.5.8
Storage setup	Setup parameters regarding storage function of UQ1 unit.	4.5.9
Monitor screen	---	---
Measured result	Shows measured result and evaluated result.	4.6.1
Storage data.	Shows stored data on the graph.	4.6.2
Waveform graph	Shows Waveform graph (only with the sensor head that support it).	4.6.3

4.1.3 Software overview

Overview of this software is as follows.

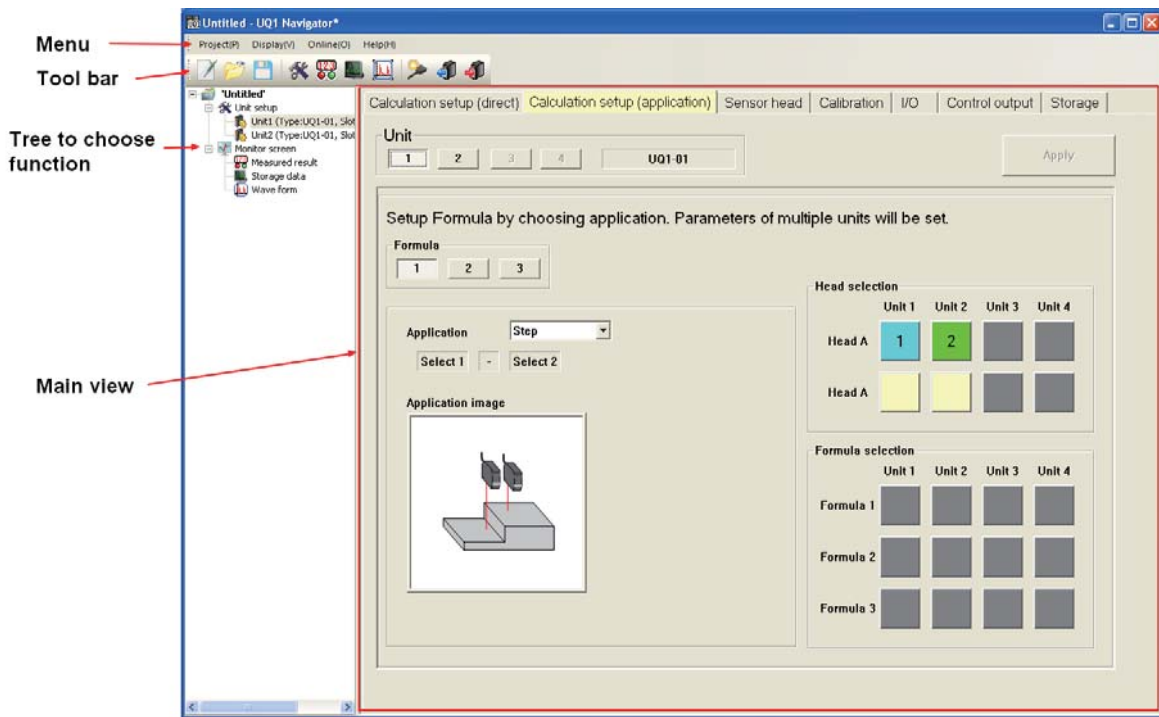











Item	Description	Reference
Menu	Shows menu of function.	4.1.4
Tool bar	Shows tool buttons to choose function.	4.1.5
Tree to choose function	You can choose function clicking each function on the tree.	---
Main view	This is the main view of this software including set-up and monitor screen.	---

4.1.4 Menu

Item	Description	Reference
Project (P)	---	---
New project (N)	Create new project.	4.3.1
Open project (O)	Open a project.	4.3.2
Save (S)	Save the file overwriting.	4.3.3
Save as (A)	Save the project as ---.	
Exit (X)	Exit the UQ1 Navigator.	---
View (V)	---	---
Unit setup (U)	Shows the unit setup screen.	4.5.1
Measured result (M)	Shows the measured result on the screen.	4.6.1
Storage data (S)	Shows storage data.	4.6.2
Waveform graph (R)	Shows Waveform on the graph.	4.6.3
Online (O)	---	---
Set destination (T)	Shows screen to set destination.	4.4.1
Readout setup (R)	Readout UQ1 unit setup through MELSEC CPU.	4.4.3
Write setup (W)	Write setup to UQ1 unit through MELSEC CPU.	4.4.4
Help (H)	---	---
Version (V)	Shows version of the software.	---

4.1.5 Tool bar

Item	Description	Reference
New project 	Create new project.	4.3.1
Open 	Open a project.	4.3.2
Save 	Save the project.	4.3.3
Unit setup 	Shows unit setup screen.	4.5.1
Measured result 	Shows measured result.	4.6.1
Storage data 	Shows stored data on the screen.	4.6.2
Waveform 	Shows Waveform graph.	4.6.3
Set destination 	Shows setup screen to set destination.	4.4.1
Readout setup 	Readout UQ1 unit setup through MELSEC CPU.	4.4.3
Write setup 	Write setup to UQ1 unit through MELSEC CPU.	4.4.4

4.2 Software installation

4.2.1 Installation procedure

Installation procedure is as follows. This is example on Windows XP.

Tips

- Please close other application before installation.
- Please log on as Administrator when you install the software.

Start installation

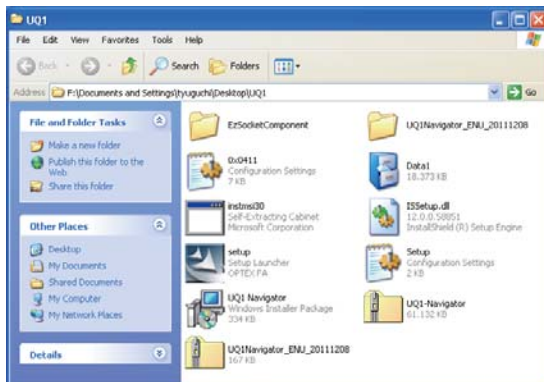

1. Please double click "Setup.exe" to startup install program.

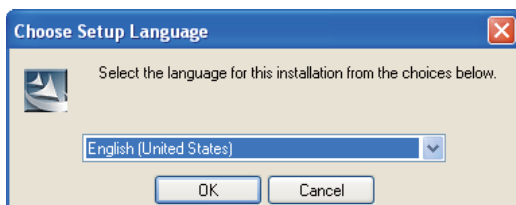

2. Please choose the language and click "OK".

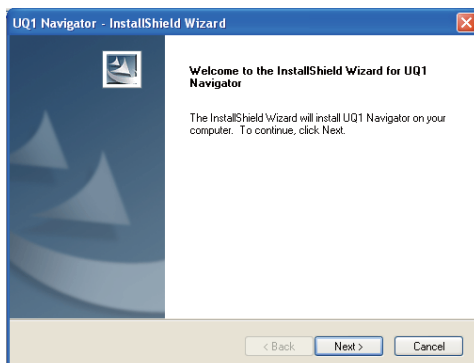

3. Please click "Next".



Continue to next page

Continue from previous page

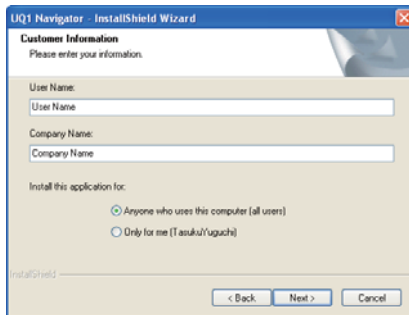

4. Please input user information and click "Next".

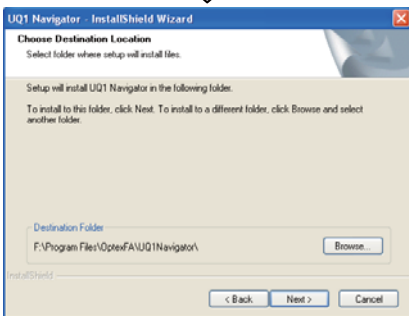

5. Please choose destination folder and click "Next".

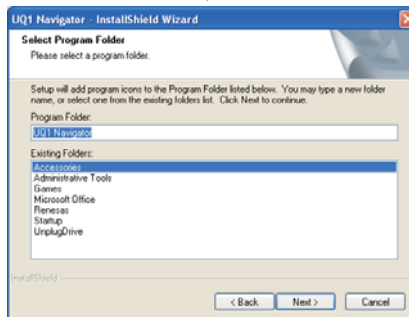

6. Please choose program folder and click "Next".

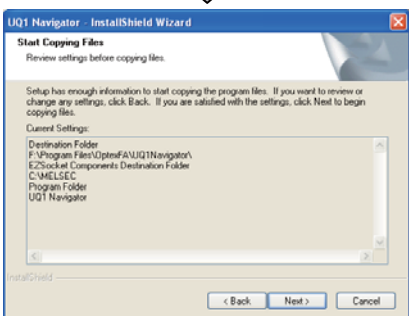

7. Installation is ready now. Please click "Next".

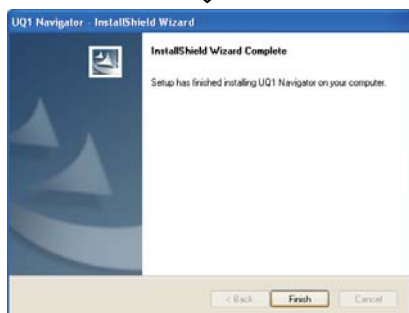

8. When left dialog box is shown, please click "Complete".

4.2.2 Uninstallation procedure

Uninstallation procedure is as follows. This is example on Windows XP.

Tips

- Please exit setup software and referring UQ1 manuals.
- Please log on as Administrator when you install the software.

Start uninstallation



1. Click "Start" -> "Control panel" -> "Add or Remove Programs".



2. Choose "UQ1 Navigator" in the program list and click "Change/Remove".



Continue to next page

Continue from previous page

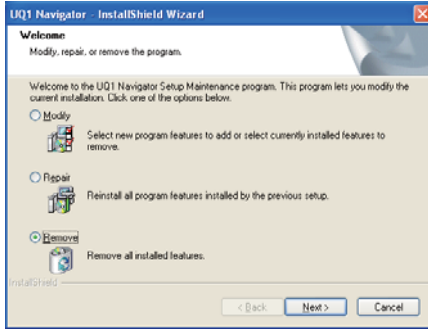

4. Choose "Remove all installed features." and click "Next".



5. Click "Yes" then uninstallation will start.

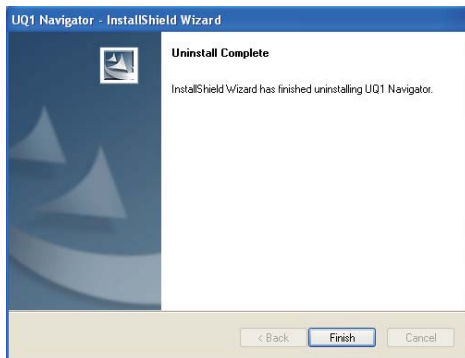

6. Dialog box like left picture will show then click "Finish" to complete uninstallation.

4.2.3 Starting up setup software "UQ1 Navigator"

Following is procedure of starting up.

1. Click "Start" -> "OPTEX FA" -> "UQ1 Navigator" -> "UQ1 Navigator".

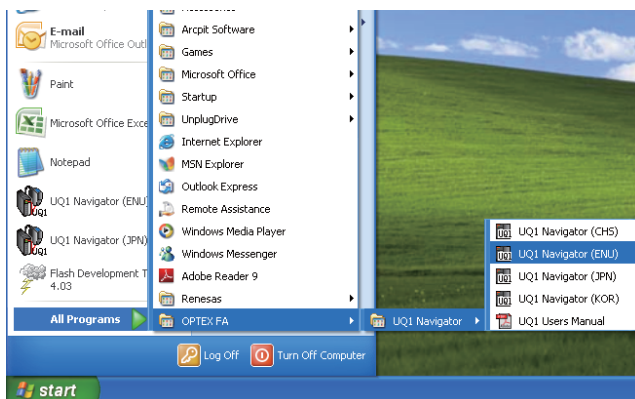

4.3 Storing / Loading setup parameters

4.3.1 New project

New project will be created.

The project has been edited will be discarded.

● Procedure

- 1 Choose "Project" -> "Create new file" at the menu or click  (Create new file) at tool bar.

4.3.2 Open project

Open project file stored.

● Procedure

- 1 Choose "Project" -> "Open" at the menu or click  (Open) at tool bar.
- 2 The dialog box "Open file" will show then choose the project file (attribute: UQ1) and click "Open".



4.3.3 Save project

Save the current setup parameters into project file.

● Procedure

(a) Over writing

Choose "Project" -> "Save" at the menu or click  (Save) at tool bar.

(b) Saving as

- 1 Choose "Project" -> "Save as" at menu.
- 2 The dialog box "Save as" as following shows then specify the project file name (attribute: UQ1) and click "Save".



4.4 Connection with the sequencer

4.4.1 Set destination

Setup communication with MELSEC CPU.

● Procedure

Choose "Online" -> "Set destination" or click at the menu  ("Set destination") at tool bar.

● Dialog box

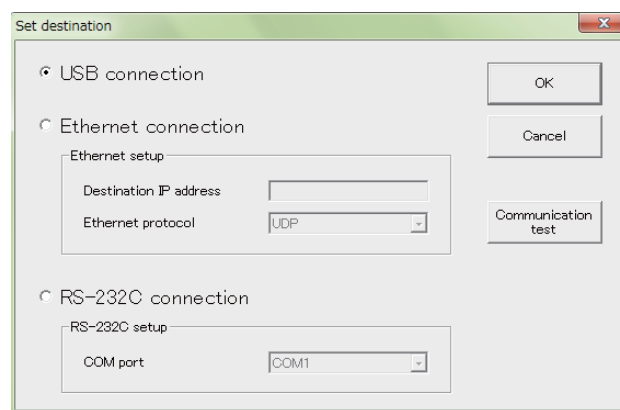

Item	Description	Reference
USB connection	Connection to USB port on the MELSEC CPU.	---
Ethernet connection *1	Connection to Ethernet port on the MELSEC CPU. Please refer following "MELSEC Ethernet communication" in detail.	---
Destination IP address	Specify IP address of the Ethernet port on the MELSEC CPU.	---
Ethernet protocol	Fixed by "UDP/IP".	---
RS-232C connection *2	Connection to RS-232C port on the MELSEC CPU.	---
COM port	Specify the COM port of the PC that the software runs on.	---

*1: You can't connect to the Ethernet unit (QJ71E71-100) of MELSEC Q series.

*2: You can't connect to the serial communication unit (QJ71C24N/R2/R4) of MELSEC Q series.

● MELSEC Ethernet communication

When using the Ethernet port on MELSEC CPU, you have to setup as follows.

- 1 Setup as follows at "Built-in Ethernet port setup" of "Q parameter setup" on "GX Developer".

IP address: Set IP address as you want.

Connection with the sequencer

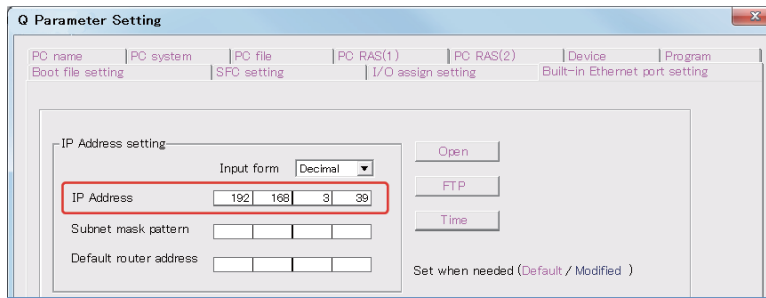

* Set "Destination IP address" as the IP address set here.

2 Open "Open setup" and set the port more than one as follows.

Protocol: UDP

Open method: MELSOFT connection

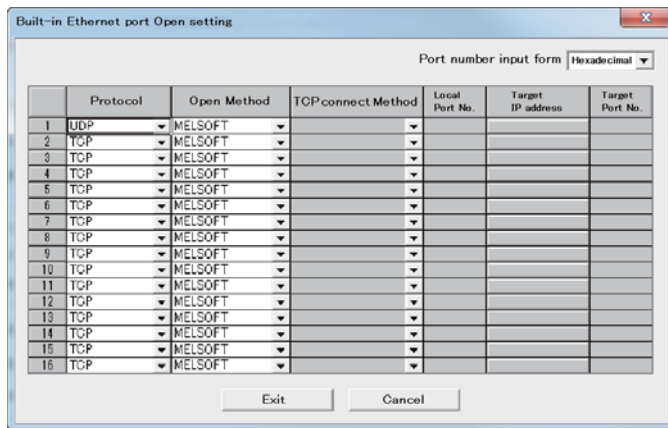

4.4.2 USB Driver setting

USB Driver setting window will show up when you connect the PC to Melsec-Q series through USB for the first time. Please install USB driver regarding following procedure.

When you fail installing the driver, please try installing through "Device Manager".

Please note that the setup window for installation varies according to the OS.

● Installing procedure

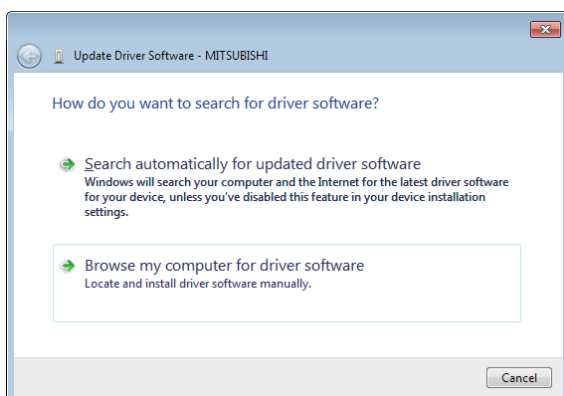

1. When the window "Update Driver Software" shows, please click "Browse my computer for driver software".

- Window XP will show "Hardware Update Wizard" window. Please check "Install from a list or specific location" and click "Next".

Continue from previous page

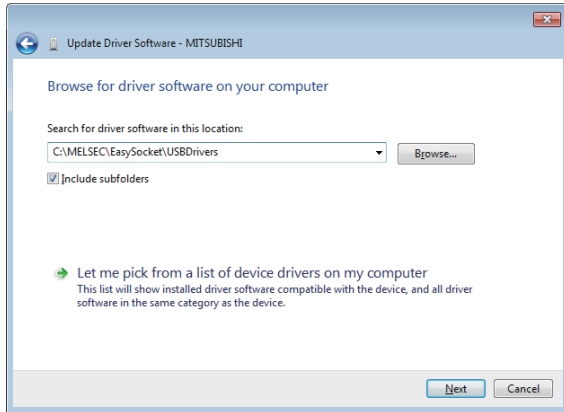

2. Please input at "Search for driver software in this location" as "C:\MELSEC\EasySocket\USBDrivers" and click "Next". You can set the folder referring by clicking "Browse" button.

- The location of the driver depends on your PC. It might be at "C:\Program Files\MELSOFT\Easysocket\USBDrivers".

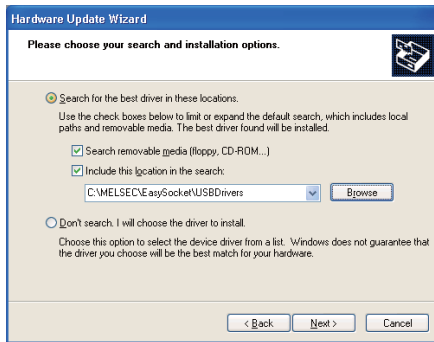

- Window XP will show "Hardware Update Wizard" window. Please choose "Search for the best driver in these locations" and check "Include this location in the search" then, set the location as above.

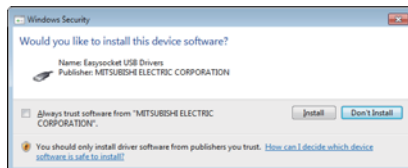

3. "Windows Security" window will be shown so please click "Install".



- Window XP will show warning window as left picture. Please click "Continue Anyway".

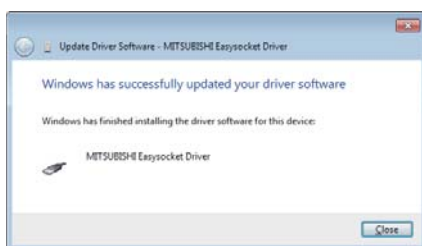

4. Installation of the driver software will be successfully finished. Please click "Close" and finish installation.

● When the window "Update Driver Software" doesn't show

When the window "Update Driver Software" or "Found New Hardware" or "Hardware Update Wizard" doesn't show automatically, please run "Device manager" and install the driver.

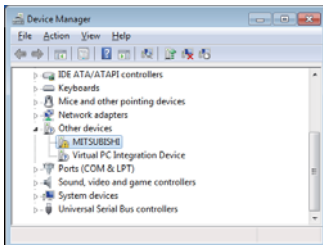
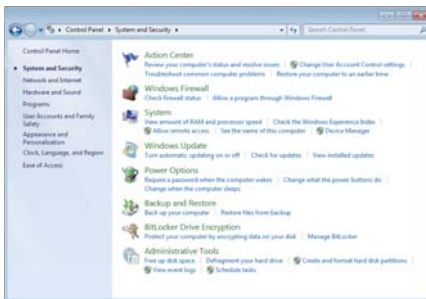

1. From "Start menu", choose "Control Panel" and then, double click "System and Security".

2. Click "Device Manager" in the "System" part.

3. In the "Device Manager" window, right click at "MITSUBISHI" in the "Other devices" and choose "Update device" then, installation of the driver will start.

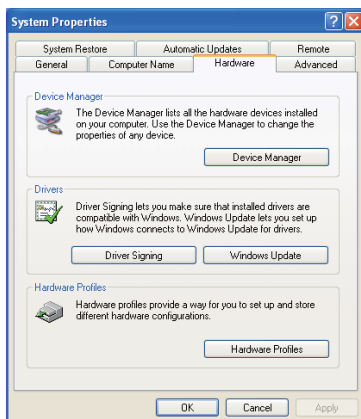

- To show "Device Manager" window in case of Window XP, please right click "My Computer" and choose "Property". "System Properties" window will show up then, please click "Device Manager".

4.4.3 Readout setup

Readout setup parameters of UQ1 unit through MELSEC CPU.

● Procedure

1 Choose "Online" -> "Load setup parameters" at the menu or click  ("Load setup parameters") at tool bar.

2 Following dialog box shows for confirmation of reading out setup parameters.

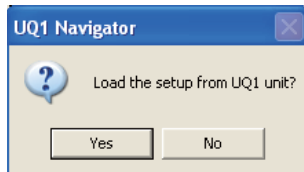

Click "Yes" to readout all setup parameters of the UQ1 unit.

Click "No" just to exit.

4.4.4 Write setup

Over write setup parameters to UQ1 unit through MELSEC CPU.

● Procedure

- 1 Choose "Online" -> "Store setup parameters" at the menu or click  ("Store setup parameters") at tool bar.
- 2 Following dialog box shows for confirmation of writing setup parameters.

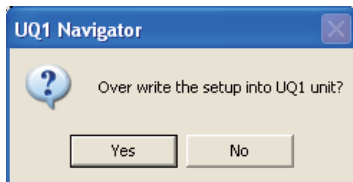

Click "Yes" to over write parameters to all UQ1 unit.

Click "No" just to exit.

- 3 When click "Yes" at 2, following dialog box shows for confirmation of writing setup parameters of all Banks.

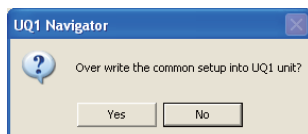

Click "Yes" to over write setup parameters of all 60 Banks to UQ1 unit.

Click "No" to over write only common setup parameters to UQ1 unit.

Tips

It will take certain time to over write setup parameters of all 60 Banks. Please click "No" at 3 if you don't need over writing parameters.

4.5 Setup procedure

4.5.1 Unit setup

Please setup as follows.

● Procedure

Choose "View" -> "Unit setup" at the menu or click  ("Unit setup") at tool bar.

● Dialog box

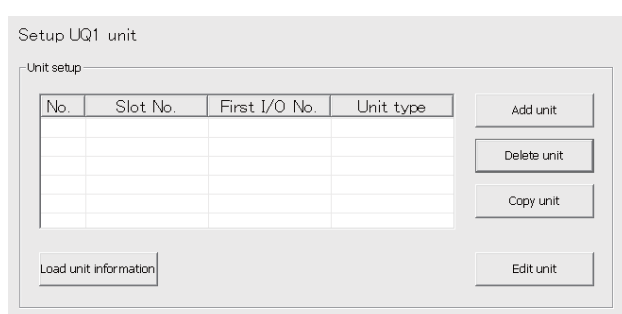

Item	Discription	Reference
Unit setup	Changing UQ1 unit configuration and showing the list.	---
Add unit	Adding UQ1 unit.	---
Delete unit	Deleting UQ1 unit.	---
Copy unit	Copying setup of UQ1 unit.	---
Edit unit	Changing slot No. and first I/O No. of UQ1 unit.	---
Load unit information	Load setup parameters of all UQ1 unit from MELSEC CPU. Please refer [4.4 Connection with the sequencer] in detail.	4.4

● Unit configuration list

Discription in detail of UQ1 unit configuration list is as following.

- No. : Shows number of order of UQ1 units.
The number goes as "1", "2", "3", "4"--- from small slot number.
- Slot No. : Shows slot number in decimal the UQ1 unit is installed (0~63).
- First I/O No. : Shows first I/O number of the UQ1 unit in 4 digit hexadecimal (0000~3FE0).
- Unit information : Shows UQ1 unit information in detail.

By double clicking "Unit information", it goes to "Calculation setup (direct)" of the UQ1 unit.

* FirST communication (infrared communication) can be done between two adjoining UQ1 units.

The data will be transferred from the unit at bigger slot number to smaller slot number.

● Add unit

Setup procedure

You can add unit by clicking "Add unit". It shows a dialog box to set slot number (decimal) and first I/O number (hexadecimal).

You can add UQ1 unit up to 4 units.

You can't assign same slot number or first I/O number that you have used for other units.

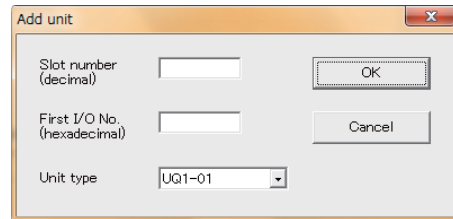

● Delete unit

You can delete unit by clicking "Delete unit". It shows a dialog box to confirmation of deleting unit. By clicking "Yes", it deletes the unit.

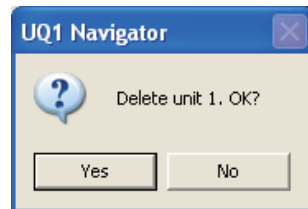

● Copy unit

By clicking "Copy unit" after choosing unit to copy from, it shows a dialog box.

Please input unit number of copy source and destination then click "OK". It copies setup of source unit to destination unit.

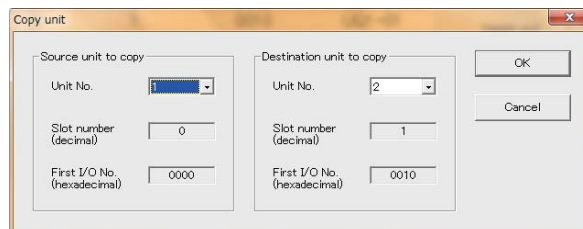

● Edit unit

By clicking "Edit unit" after choosing unit to edit, it shows a dialog box.

Please change the slot number and first I/O number then click "OK". It changes slot number and first I/O number.

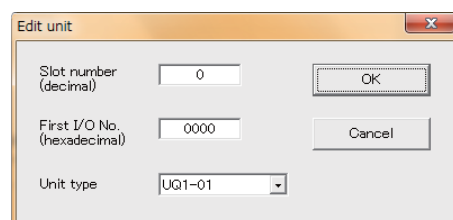

4.5.2 Operation of setup screen

You can choose each setup screen by clicking the tab.

(a) From unit setup screen

You can change the screen by clicking unit information at unit setup screen to "Calculation setup (direct)".

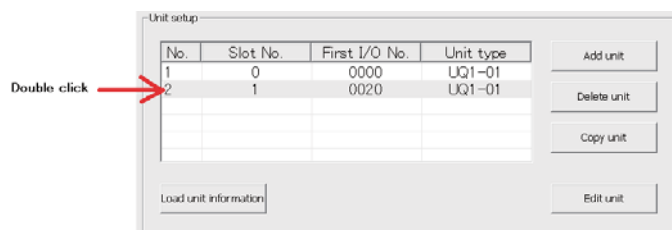

(b) From screen selection tree

You can change the screen by clicking unit information under "Unit setup" to "Calculation setup (direct)" for the selected unit.

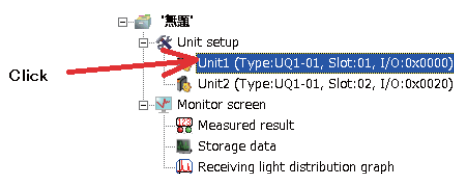

On the setup parameter screen, you can change the screen by clicking each tab.

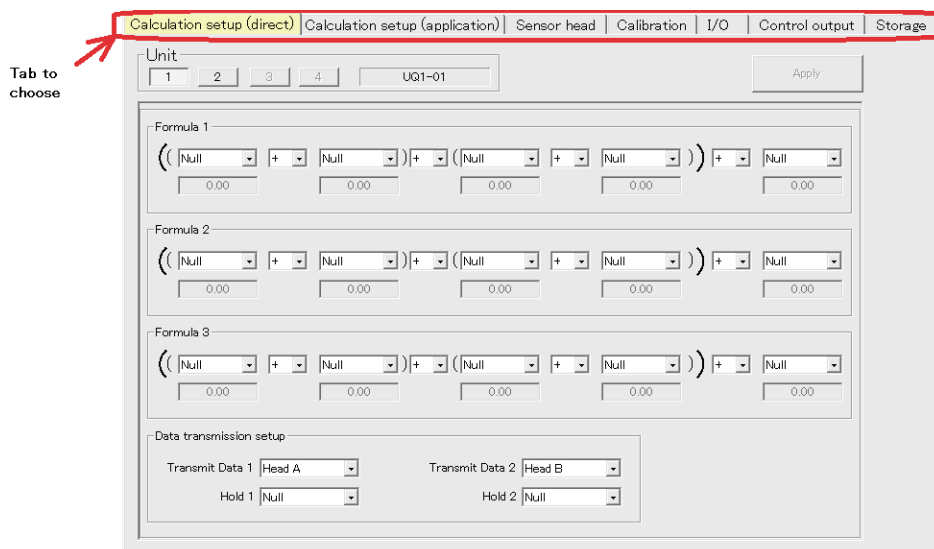

Tips

- Before you change the screen, please click "Apply" button to confirm changing parameters.
- When you change the screen without clicking "Apply" button, following dialog box will show.

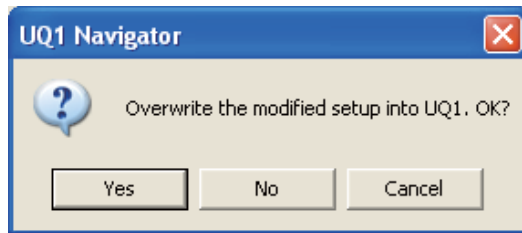

"Yes": Confirm changing parameters and go to another screen.

"No": Discard changing parameters and go to another screen.

"Cancel": Go back to previous screen.

- The parameters confirmed by clicking "Apply" won't be set actually in UQ1 unit until over writing process is done. Please refer [4.4.3 Write setup].
-

4.5.3 Calculation setup (Direct)

You can specify elements and operators for the calculation directly.

● Procedure

Click "Calculation setup (Direct)" to set parameters for calculation.

Please refer [4.5.2 Operation of setup screen] in detail.

● Screen

Item	Discription	Reference
Formula 1 Formula 2 Formula 3	Specify the calculation formula. The result will be used as measured result. 3 Formulas can be set per unit. Please refer [Setup of Formula] in detail.	3.2.3
Formula source 1~5 Fixed value 1~5	Specify source of the formula. Default is "None". Specify fixed value for the source of the formula. Default is "0.00". Please refer [Setup Fixed value] in detail.	3.2.3
Operator 1~4	Specify operator for the formula. Default is "+".	
FirST data setup	---	---
Transmit data 1 Transmit data 2 Hold 1 Hold 2	Specify which data to transmit by FirST from slave side to master side. The data transferred through FirST is referred as "Receiving data 1" or "Receiving data 2" at master side unit. Specify hold process of transferred data. Please refer [3.3 Hold mode and process] in detail.	3.2.5

* FirST communication can be done between adjoining two units (master side and slave side: units at smaller slot number and bigger slot number). Please refer [4.5.2 Operation of setup screen].

Setup procedure

● Setup Fixed value

Following shows how the fixed value is set and its unit.

When proximate operator is "+" or "-"

The unit is μm .

Example: Subtracting 500 μm from Head B measured value.

Formula 1

((Head B - Fixed value) + (Null + Null)) + Null

0.00 500.00 0.00 0.00 0.00

* Hundredfold of the fixed value will be stored into shared memory of UQ1 unit in this case.

When proximate operator is "*" or "÷"

The fixed value will be treated as integer without unit.

Example: Calculate average of measured value of Head A and B.

Formula 1

((Head A + Head B) / Fixed value) + Null

0.00 0.00 2 0.00 0.00

* The value will be stored as it is into shared memory of UQ1 unit in this case.

● Setup of Formula

Following shows how to setup formula that is explained at "Example of Formula setup" in [3.2.3 Q1~Q5 / Calculation setup].

Calculation of thickness

Example: When the thickness of the object is 10mm and "A+B" is 9.2mm.

Formula 1

((Head A + Head B) + Fixed value) + Null

0.00 0.00 800.0 0.00 0.00

* The "Fixed value" is "800" ($L=t-A-B$ then $10\text{mm} - 9.2\text{mm} = 0.8\text{mm} = 800\mu\text{m}$).

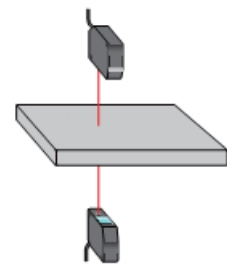

Calculation of step height

Height of the step from the base is calculated by "H=A-B".

Formula 1

((Head A - Head B) + (Null + Null)) + Null

0.00 0.00 0.00 0.00 0.00

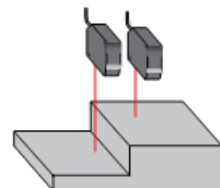

Calculation of inclination

Example: Calculation of inclination $\theta = (A-B)/L$ (L is distance of two sensor heads). When L = 80mm.

Formula 1

((Head A - Head B) / (Fixed value + Null)) + Null

0.00 0.00 80000 0.00 0.00

* The fixed value is "80000" (μm).

Getting measured data from adjoining unit

Example: When calculating average of two Head A connected to each UQ1 unit.

- UQ1 unit 1 (master side)

Formula 1

((Head A + Input data) / (Fixed value + Null)) + Null

0.00 0.00 2 0.00 0.00

- UQ1 unit 2 (slave side)

Set "F1rST transmit data 1 setup" (shared memory address 109): 0 (Head A)

Getting data from the unit not adjoining

For example, when you use 3 UQ1 units connected as following picture, the data from unit 3 can be transferred to unit 1 through unit 2. Unit 1 can't get the data from unit 3 directly. In this example case, Formula 3 of unit 2 is used to assign Receiving data 1 as F1rST Transmit data 1.

- UQ1 unit 1 (master side)

Formula 1

((Head A - Input data) + (Null + Null)) + Null

0.00 0.00 0.00 0.00 0.00

- UQ1 unit 2 (center unit)

Formula 3

((Input data + Null) + (Null + Null)) + Null

0.00 0.00 0.00 0.00 0.00

Set "F1rST Transmit data 1" (shared memory address 109): 4 (Formula 3)

- UQ1 unit 3 (slave side)

Set "F1rST Transmit data 1" (shared memory address 109): 0 (Head A)

4.5.4 Calculation setup (Application)

Setup calculation formula by choosing application.

● Procedure

Click "Calculation setup (Application)" tab at setup screen.

Please refer [4.5.2 Operation of setup screen] in detail.

● Screen

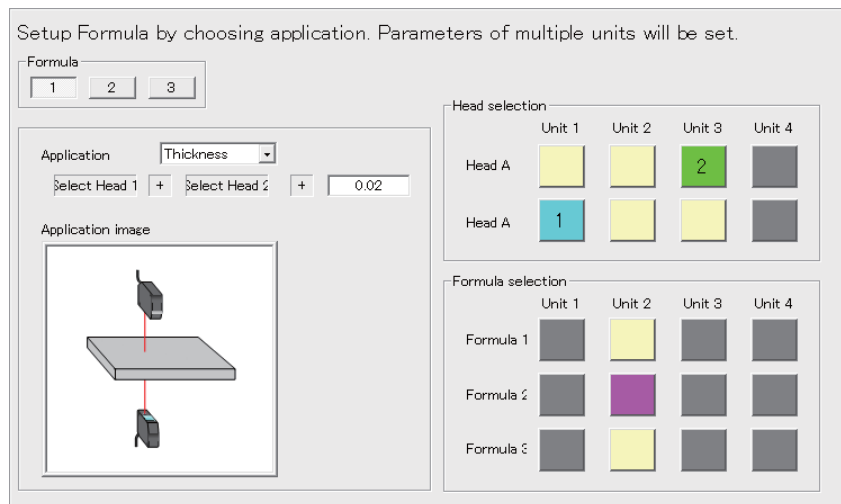

Item	Description	Reference
Application	Choose measurement application	
Step	Measure step difference using two measured result.	
Thickness	Measure thickness using two measured result.	
Average	Calculate average of two measured result.	---
Choosing sensor head	Choose sensor head to use for calculation.	---
Choosing formula	Choose formula for the unit in between two other UQ1 units to get measured result from a UQ1 unit that is not adjoining to the unit.	---

Please refer [4.5.1 Unit setup].

● Setup of formula by choosing application

To setup formula directly, please refer [4.5.3 Calculation setup (direct)].

1 Choose application accordingly

The formula differs according to the application.

When choose "Step"

Measure step height by using two sensor heads.

The formula will be ["Head 1" - "Head 2"].

When choose "Thickness"

Measure thickness by using two sensor heads.

the formula will be ["Head 1" + "Head 2" + "Fixed value"].

When choose "Average"

Calculate average of two measured result of two sensor heads.

The formula will be [("Head 1" + "Head 2" ÷ 2)].

- 2** Click the button to choose sensor head and formula for center unit at "Choosing sensor head" and "Choosing formula".

Setup Formula by choosing application. Parameters of multiple units will be set.

Formula
1 2 3

Application: Step
Select Head 1: [] Select Head 2: []

Application image

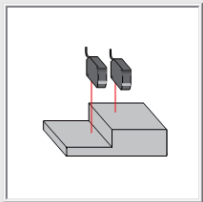

Head selection

	Unit 1	Unit 2	Unit 3	Unit 4
Head A	Yellow	Yellow	Yellow	Grey
Head B	Yellow	Yellow	Yellow	Grey

Formula selection

	Unit 1	Unit 2	Unit 3	Unit 4
Formula 1	Grey	Yellow	Grey	Grey
Formula 2	Grey	Yellow	Grey	Grey
Formula 3	Grey	Yellow	Grey	Grey

The color of the button changes from "1" (Blue) to "2" (Green) and to "not used" (Yellow) at "Choosing sensor head". Please set "1" for "Head 1" and "2" for "Head 2".

The color of the button changes from "use" (Purple) to "not used" (Yellow) at "Choosing formula". Please set the formula as "use" for center unit.

Setup procedure

When measure with single UQ1 unit

When measure step height using Head A and Head B connected to single UQ1 unit (unit 1), setup is as follows.

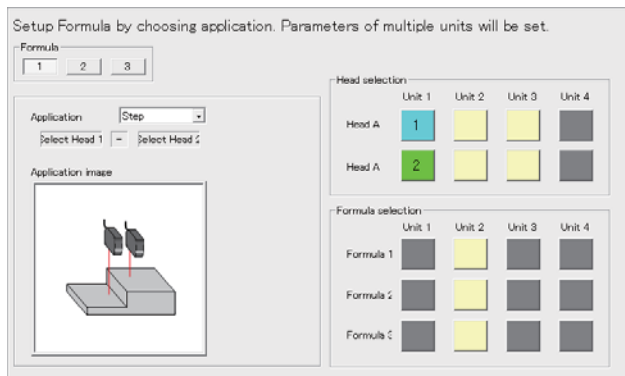

- UQ1 unit 1

Formula is set as ["Head A" - "Head B"].

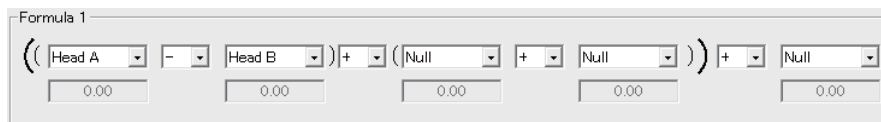

When measure using adjoining two UQ1 units.

When measure thickness by using adjoining two UQ1 units (Head A connected to Unit 1 and Head B connected to Unit 2), setup is as follows.

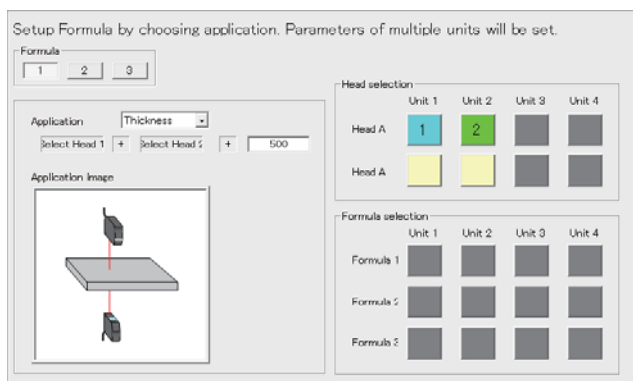

- UQ1 unit 1 (master side)

Formula is set as ["Head A" + "Receiving data 1" + "Fixed data"(500.00)].

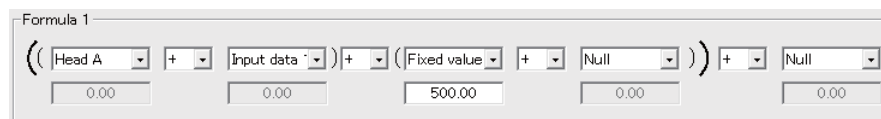

- UQ1 unit 2 (slave side)

"Head A" is set for "FirST Transmit data 1".

When measure with more than adjoining 3 UQ1 units

When measure average of two sensor heads connected to unit 1 and unit 2, setup is as follows (unit 2 just transfer the data from unit 3).

* In this example case, formula 3 is used at unit 2 to transfer the data.

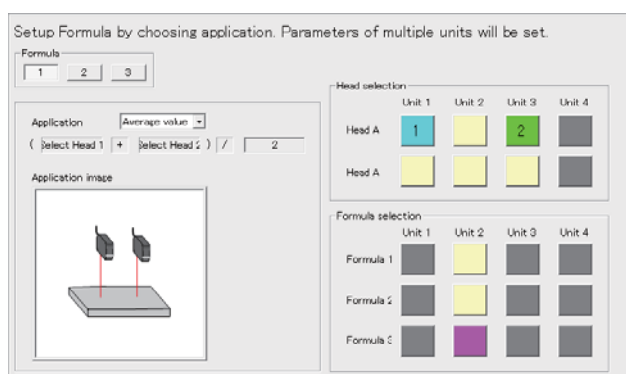

- UQ1 unit 1 (master side)

The formula is set as ["Head A" + "Receiving data 1" ÷ "Fixed value"(2)].



- UQ1 unit 2 (center unit)

The formula 3 is set as ["Receiving data 1"].

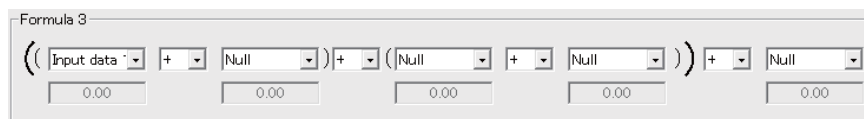

"FIRST Transmit data 1" is set as "Formula 3".

- UQ1 unit 3 (slave side)

"FIRST Transmit data 1" is set as "Head A".

Tips

- Please don't change the formula chosen at center unit by calculation setup.
- When measure using more than two UQ1 units, if "FIRST Transmit data" of UQ1 at slave side is used for other formula, you can't make any formula.
- When add/delete unit at "Unit setup" screen, all setup of "Calculation setup (Application)" will be deleted.

* Formula won't be deleted.

4.5.5 Sensor head setup

Setup parameters relevant to measurement by sensor head itself.

● Procedure

Click "Sensor head" tab at setup screen.

Please refer [4.5.2 Operation of setup screen] in detail.

● Screen

UQ1-01

Calculation setup (direct) | Calculation setup (application) | **Sensor head** | Calibration | I/O | Control output | Storage

Unit: 1 | 2 | 3 | 4 | UQ1-02 [Apply]

Sensor head A setup

Measurement target: Peak
 Laser power: ON
 Moving average number: 16 time (Standard)
 Sampling period: 500 us

Sensor head B setup

Measurement target: Peak
 Laser power: ON
 Moving average number: 16 time (Standard)
 Sampling period: 500 us

UQ1-02

Calculation setup (direct) | Calculation setup (application) | **Sensor head** | Calibration | I/O | Control output | Storage

Unit: 1 | 2 | 3 | 4 | UQ1-01 [Apply]

Sensor head A setup

Measurement target: Surface
 Laser power: 5
 Moving average number: 256 time
 Sampling period: 100 us
 Diffuse/Specular: Diffuse
 Sensitivity setup: AUTO
 Threshold for peak detection: 0

Sensor head B setup

Measurement target: Surface
 Laser power: 5
 Moving average number: 256 time
 Sampling period: 100 us
 Diffuse/Specular: Diffuse
 Sensitivity setup: AUTO
 Threshold for peak detection: 0

Head A/B common setup

Cross talk prevention function: OFF
 Cutoff frequency: 0
 Filter: OFF

Item	Description	Reference
Sensor Head A setup Sensor Head B setup	---	
Measurement target	Specify measurement target - Peak: Measure most reflective surface (UQ1-02). - Surface: Measure first surface. - Flip side: Measure 2nd surface. - Glass thickness: Measure the distance between first surface and 2nd surface. - Glass gap: Measure the distance between 2nd surface and 3rd surface (UQ1-01). Use "Surface" or "Peak" normally. Diffuse type of CD33 must be used as "Peak".	
Diffuse/Specular (Only with UQ1-01)	Specify its mode.	
Laser power	- UQ1-01: Set laser power from "1" (Minimum) to "5" (Maximum). When "0" is set, it doesn't emit laser. - UQ1-02: Specify ON/OFF of laser power.	
Sensitivity setup (only UQ1-01)	Setup sensitivity of photoelectric sensor. Set "AUTO" normally. When set "AUTO", it adjust sensitivity depends on reflection from work piece automatically. Please set from "0" (Minimum) to "10" (Maximum) when you set manually.	3.2.1
Waveform threshold (only UQ1-01)	Setup threshold to detect peak in the Waveform data. It's used with "0" normally. Please set from "0" (low) to "14" (high) when you setup manually. When it's set "AUTO", it will measure in anycase but resolution might be worse.	
Moving average number	Setup moving average number. The bigger number, the more stably it can measure and it can prevent too much effect from fine roughness of the surface. The smaller number, the quicker it can response. Default is "256"(UQ1-01) / "16"(UQ1-02).	
Sampling period	Setup sampling period of measurement. The smaller period, the faster response but sensitivity will be worse. You can set "AUTO" with UQ1-01. CD5 series sensor head adjust sampling period automatically to measure in optimum condition. Default is "100us"(UQ1-01) / "500us"(UQ1-02).	
Sensor head A/B common setup	* only for UQ1-01.	
Prevent cross talk function	This function prevent cross talk between two sensor heads though, sampling period will be 6 times longer. Default is "OFF".	
Filter	You can use "High pass filter" or "Low pass filter". Default is "OFF".	
Cut off frequency	Specify cut off frequency when you use filter function. It's from "0"(high) to "7"(low). Default is "0".	3.2.1 6.1.1

4.5.6 Calibration setup

Setup parameters relevant to calibration of the sensor head.

● Procedure

Please click "Calibration" tab at setup screen.

Please refer [4.5.2 Operation of setup screen].

● Screen

Item	Description	Reference
Setup from measured result	It calculates "Span" and "Shift" from two measured points given.	---
1st point	Click the check box accordingly when get the measured result from UQ1.	---
2nd point		
Getting measured value	Get the measured value for 1st point or 2nd point which check box is checked.	---
Measured value	Set measured value before calibration.	---
Display value	Shows the value after calibration.	---
Span, Shift direct input	Input "Span" and "Shift" directly.	---
Span	Set "Span" value. Example: When you want to increase "10mm" for every "9.5mm", the "Span" is as follows. $9.5 / 10 = 0.9500$ Default is "1.0000".	3.2.1
Shift	Set "Shift" value. Example: When you want to adjust measured value "0mm" to "+0.15mm", the "Shift" is as follows. $0.15 * 1000 = 150.00 \text{ um}$ Default is "0.00".	

● Automatic calculation of "Span" and "Shift"

Following shows how to calculate "Span" and "Shift" automatically with two measured points given.

1 Select "Setup from measured value"

2 Set two measured points

Set actual measured value before calibration into "Measured value" and expected value into "Display value". When you want to get these value from UQ1, please check the check box of "First point" or "Second point" and click "Getting measured value" button.

3 You can get calibrated "Span" and "Shift" automatically by clicking "Apply".

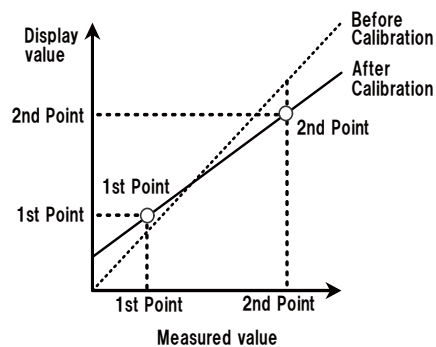

4.5.7 I/O setup

● Procedure

Please click "I/O setup" at setup screen.

Please refer [4.5.2 Operation of setup screen] in detail.

● Screen

Item	Description	Reference
Input setup	---	---
Input terminal 1	Specify which target the "Trigger IN1" and "Trigger IN2" to use for.	3.2.5
Input terminal 2	Default is "Head A" for "Trigger IN1" and "Head B" for "Trigger IN2".	
Timing of data sampling	Specify process mode of "Trigger IN1" and "Trigger IN2". - OFF: Retrieve data while the trigger is OFF. - ON : Retrieve data while the trigger is ON. - Up edge: Retrieve data at trigger up edge. - Down edge: Retrieve data at trigger down edge. Default is "OFF". When the input is specified as "RESET", it works at upedge.	
Output setup	---	---
Output terminal 1	Specify which evaluated result to output from "Signal OUT1" and "Signal	3.2.5
Output terminal 2	OUT2". Default is "Q1" for "Signal OUT1" and "Q2" for "Signal OUT2".	
Signal Out logic	Specify logic of "Signal OUT1" and "Signal OUT2". - 0: All normal (ON when NG. OFF when OK). - 1: OUT1 is reverse (OUT1 is ON when OK). - 2: OUT2 is reverse (OUT2 is ON when OK). - 3: All reverse (ON when OK. OFF when NG). Default is "0" (All normal).	
One shot	Specify if set one shot output or not. Default is "OFF".	

ON delay OFF delay	Specify if use ON/OFF delay or not and delay time in "ms" from "0" to "65535". Default is "0".	
-----------------------	---	--

4.5.8 Control output setup

● Procedure

Please click "Control output setup" at setup screen.

Please refer [4.5.2 Operation of setup screen] in detail.

● Screen

Item	Description	Reference
Control output setup	---	---
Q1~Q5 Source	Specify the source for Q1~Q5. Default is "Head A" for Q1, "Head B" for Q2 and "None" for others.	3.2.3
Q1~Q5 Hold	Specify hold mode of Q1~Q5. Default is "None".	
Bank number	Specify Bank number to readout/overwrite "Upper/Lower threshold" and "Offset" of Q1~Q5 from/to the PLC. Please set from "0" to "59".	---
Readout Bank setup	Readout "Upper/Lower threshold" and "Offset" of Q1~Q5 from specified Bank.	---
Over writing Bank setup	Over write "Upper/Lower threshold" and "Offset" of Q1~Q5 set on the screen to specified Bank.	---
Lower limit Upper limit	Specify threshold of Q1~Q5. Set from "-2147483648" to "2147483647". Default is "-75000000" for Lower limit and "75000000" for Upper limit.	3.2.8
Offset	Specify offset of Q1~Q5. Set from "-2147483648" to "2147483647". Default is "0".	
Hold mode	Specify Hold mode. Default is "Auto". Please refer [3.3 Hold mode and process] in detail.	3.2.4 3.3

Hysteresis	Specify hysteresis of Q1~Q5 that means level difference from "ON" to "OFF". Set from "0.00" to "21474836.47". Default is "0.00".	3.2.4
High speed mode	Specify if let it work in high speed mode or not. In high speed mode, it doesn't average while processing. Default is "OFF".	3.2.2

Tips

- You can over write every Bank one by one and also over write all 60 Banks at a time on this setup screen.
 - Over writing one by one is recommended because over writing 60 Banks at a time.
 - If you want to over write 60 Banks at a time, please refer [4.4.3 Write setup].
-

4.5.9 Storage setup

● Procedure

Please click "Storage" tab on the setup screen.

Please refer [4.5.2 Operation of setup screen] in detail.

● Screen

The screenshot shows the 'Storage' tab of a setup screen. At the top, there are navigation tabs: 'Calculation setup (direct)', 'Calculation setup (application)', 'Sensor head', 'Calibration', 'I/O', 'Control output', and 'Storage'. Below these is a 'Unit' section with buttons for '1', '2', '3', '4', and a text field containing 'UQ1-01', along with an 'Apply' button. The main 'Storage setup' area contains several fields:

- Storage target:** Target 1 is set to 'Q1', Target 2 is set to 'Null'.
- Hold mode:** Both Target 1 and Target 2 are set to 'Null'.
- Pointer Clear Timing:** Set to 'At RESET is ON'.
- Sampling period:** Set to '1' Point X '100' us.
- Time of storing data:** Set to '26.214' sec.
- When pointer reaches end:** Set to 'Continuous upda'.

A red note on the right side of the storage target fields states: "[Note] 'Target 2' can't be used by version 1 of UQ1-01. Please make sure to use 'Target 2' that there is number above the 'CE' mark."

Item	Description	Reference
Storage setup	---	---
Storage target	Specify target for storage. Default is "Q1".	3.2.6
Hold mode	Specify hold mode for storage. This parameter is effective only for Head A/B and Formula 1/2/3. Default is "None".	
Pointer clear timing	Specify timing to clear the storage pointer. - When trigger is ON: When trigger is ON, the pointer is cleared. - When RESET is ON: When RESET (Y09) is ON, the pointer is cleared. Default is "When RESET is ON".	

Sampling period	<p>Specify sampling period from "1" to "65536". Default is "1" and it stores every data.</p> <p>* The parameter "Data store skip number" of UQ1 will be [this number - 1].</p> <p>Example: When this number is 10, it samples data every 10 sampling period. "Data store skip number" will be "9".</p> <p>Sampling period (us) will be bigger sampling period out of Head A and Head B. Please refer [4.5.5 Sensor head setup].</p> <p>Example: When Head A: 200us and Head B: 800us, then it will be "800".</p> <p>When one of the Heads is set as "AUTO", it will be "AUTO".</p>	3.2.6 4.5.5
Time of storing data	<p>Shows total time to store all 262144 points of data.</p> <p>Example: When Sampling period is "1" and "800"us, $0.8\text{ms} * 1 * 262144 = 209715.2\text{ms}$ (around 209.715sec)</p> <p>When one of the Heads is set as "AUTO", it will show "----".</p>	---
When pointer reaches end	<p>Specify the process when the pointer reaches end of storage memory.</p> <ul style="list-style-type: none"> - Stop: Stop the storage process. - Continue from start: Clear the pointer and start storing data from start of the memory. <p>Default is "Continue from start"</p>	3.2.6

Tips

UQ1-01 later version than 2 support storing 2 measurement result.

You can confirm the version on the label.

There is version number above the "CE" mark.

With no version shown as following picture it's version 1.



If you proceed storing 2 measurement result with UQ1 of version 1, it will store only one measurement result of Q1 with Hold mode: "None".

4.6 Confirming process

4.6.1 Measured result

It monitors UQ1 measurement result and evaluation result.

● Procedure

Choose "Display" -> "Measurement result" from the menu or click the icon  "Measurement result" at choosing screen tree.

● Screen

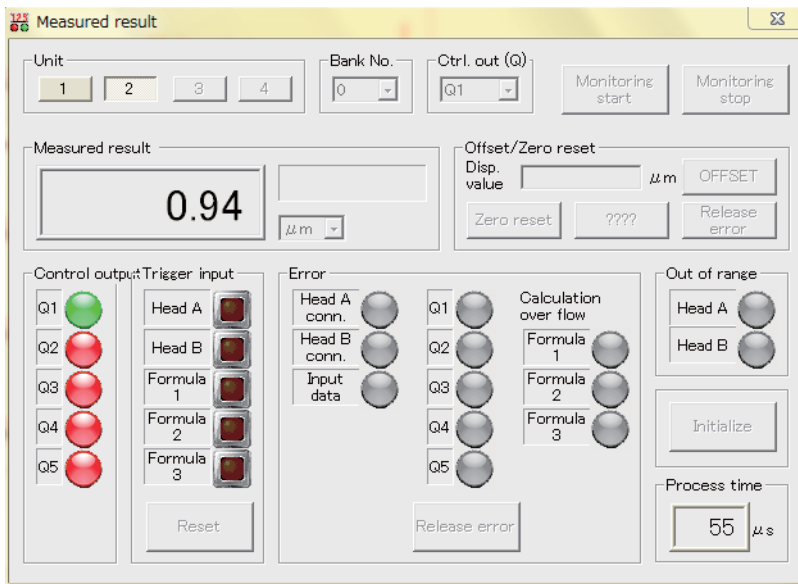

Item	Description	Reference
Unit	Choose the UQ1 unit (1~4) to monitor.	---
Bank number	Choose the Bank number (0~59) to monitor.	---
Control output (Q)	Choose the control output (Q1~Q5) to monitor.	---
Monitoring start Monitoring stop	Switch start/stop of monitoring of UQ1 control output.	---
Measurement result	Shows measurement result in μm and measurement source.	3.2.3
Zero reset	It adjust offset value so that the measurement result shows "0".	3.2.9
Out of range	Shows "Out of range" alarm of Head A/B. Alarm ON: Red Alarm OFF: Gray	---
Process time	Shows current process time in μs.	3.2.11
Control output	Shows if each control output is in the threshold or not. In the threshold: Green Out of the threshold: Red	3.1.3
Input terminal	Input trigger for Head A/B and Formula 1/2/3. ON: Blue OFF: Gray	---

Reset	Reset UQ1.	---
Error	Shows error status of sensor head connection, receiving data, each control output and calculation. Alarm ON: Red Alarm OFF: Gray	3.1.3 3.2.10
Error release	Release the UQ1 error.	---
Initialize	It shows a dialog box for confirmation by clicking the button. When you click "Yes" at the dialog box, it will initialize setup parameters.	---

4.6.2 Storage data

It shows UQ1 storage data in a graph.

● Procedure

Choose "Display" -> "Storage data" from the menu or

click "Storage data" icon  from the tool bar or screen selection tree.

● Screen

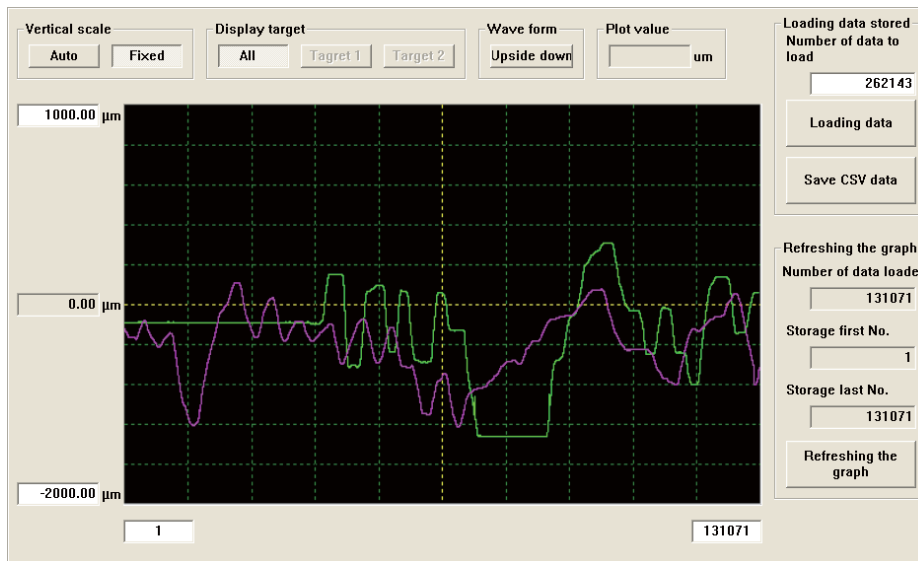

Item	Description	Reference
Vertical scale	Choose the vertical scale. Auto: Adjust the Min./Max. scale so that to display all data. Fixed: The scale is fixed with the value at the Min./Max. boxes.	---
Display data	---	---
All	Both data 1 and 2 will be displayed.	---
Data 1/2	Data 1 or 2 will be displayed.	---
Horizontal scale Min./Max.	Shows horizontal scale Min./Max. (storage first No./last No.). Please edit the scale and click "Refreshing the graph" button. * UQ1 storage data will be over written by clicking "Loading data" button.	---
Loading data stored	---	---
Number of data stored	Specify number of data sotred to load from UQ1. Set from "1" to "262144". Default is "100000".	---
Loading data	Load the data from UQ1 and show on the graph.	---
Save CSV data	Save the storage data loaded into CSV file.	---
Refreshing the graph	---	---
Number of data loaded	Shows number of data loaded.	---
Storage first No.	Shows first number of storage data loaded.	---
Storage last No.	Shows last number of storage data loaded.	---
Refreshing the graph	Refreshes and shows the graph. This is used when you refresh the graph after editing vertical and horizontal scale.	---

● Changing scale

Standard setup

Set vertical scale as "Auto" and click "Loading data" or "Refreshing the graph".

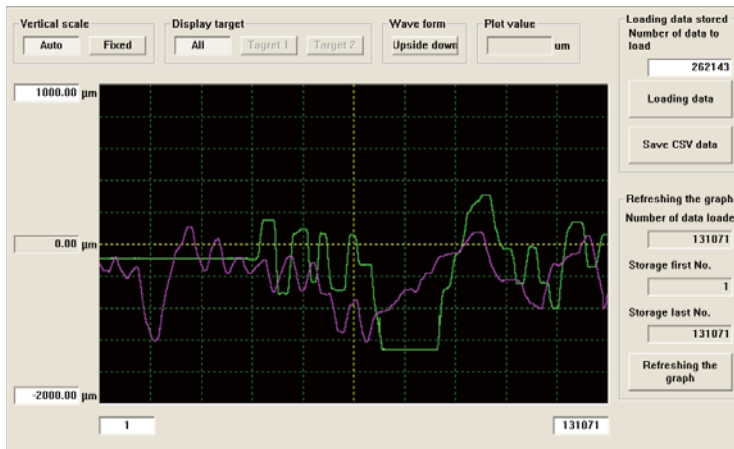

Changing vertical scale

When you change vertical scale, please click "Fixed" at Vertical scale and change the vertical Min./Max. scale value. Input the scale and click "Refreshing the graph" to show the graph in the new scale.

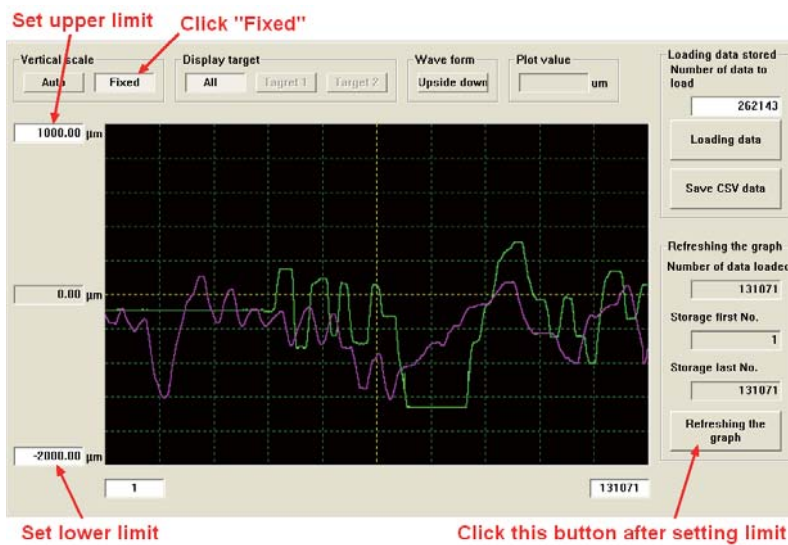

Confirming process

Changing horizontal scale

When you change horizontal scale, please change Min./Max. horizontal scale.

Input Min./Max. scale and click "Refreshing graph" to show the graph in new scale.

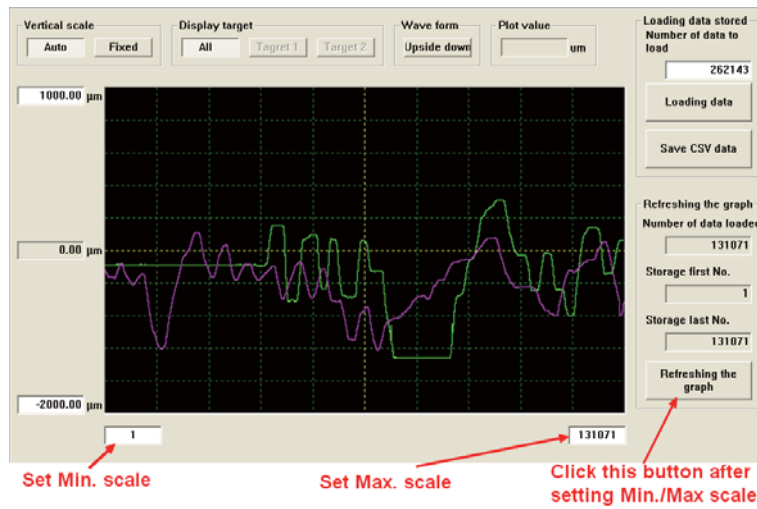

4.6.3 Waveform data

Shows Waveform. In case of CD33 series, it can show the Waveform only with specular type. Vertical axis shows light strength and horizontal axis shows distance.

Please refer [3.2.13 Waveform data] in detail.

● Procedure

Choose "Display" -> "Waveform" from the menu or

click  "Waveform" button from the tool bar or screen selection tree.

● Screen

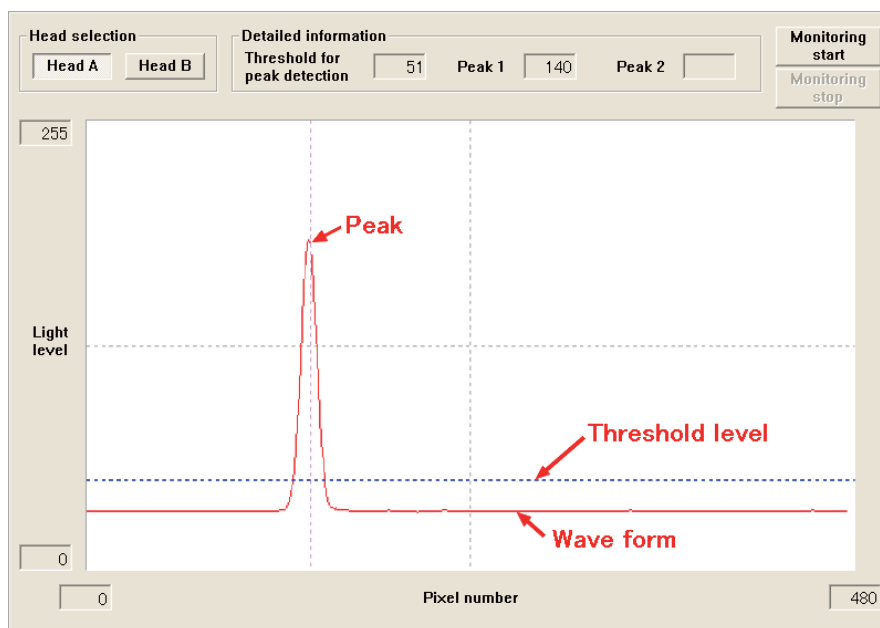

Item	Description	Reference
Head selection	Choose sensor head to monitor its Waveform.	---
Detailed information	---	---
Threshold for peak detection	Shows threshold level of Waveform to detect the peak. Blue broken line shows the threshold level.	3.2.13
Peak 1 Peak 2	Shows Peak 1/2 that CD5 recognizes as peak. Left peak is first peak and another is second peak.	
Monitoring start Monitoring stop	Switch start/stop of monitoring of Waveform through UQ1.	---

5

Trouble shooting

5.1.1 Function

LED indicators on UQ1 don't light.

UQ1 unit may not be installed on the Q bus correctly.

- Please make sure UQ1 unit is installed on the Q bus correctly.

LED indicators on CD5 don't light

Power supply may not be connected to CD5.

- Please make sure the power supply is connected correctly.

Cable may not be connected correctly.

- Please make sure the connectors of the cable are connected correctly.

The cable may be broken.

- Please try replacing the cable.
- Please make sure the cable is not used at moving part.

The laser isn't emitted

"Laser OFF" (Y12/Y13) may be 1=OFF.

- Please set "Laser OFF" as 0=ON.

"Laser power" of CD5 may be "0" (UQ1-01).

- Please set "Laser power" (shared memory 2/16) as 1~5 and set "Over writing common setup" (Y10) to over write the setup.

LED indicators light by rotation.

It means UQ1 has system error.

- When it doesn't recover after re-booting, please contact distributor you bought the unit from.

One of following LEDs light in red.

It means communication between the UQ1 unit and other equipment (QCPU, CD5/CD33, adjoining UQ1 unit).

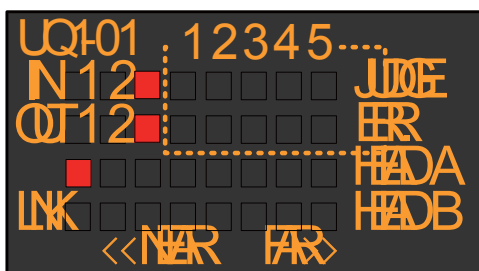

- When it doesn't recover after making sure that there is no big noise from other equipment and the connection is made correctly, please contact our distributor you bought the unit from.

ERR LED of the UQ1 unit lights

Sensor head assigned for Q1~Q5 may be not connected.

- Please make sure the sensor head is connected correctly.

5.1.2 Measurement

"Head A/B out of range alarm" is ON and measurement isn't done correctly.

Stand off distance may be not correct.

- The distance between the sensor head and the object must be in the measurement range. Please refer the manual and make sure the distance is in the range.

Angle of the sensor head may be not correct.

- Diffuse type sensor head must be mounted so the laser angle is vertical to the object. Specular type sensor head must be mounted as specified on the manual. Otherwise the sensor head won't be able to receive enough light reflected by the object.

There may be blockade between the sensor head and the object.

- The sensor head won't be able to receive light reflected by the object if there is blockade. Please make sure there is no blockade. Please refer the manual.

The reflected light may be not enough (when the object is transparent or mirror surface).

- When measure transparent object or mirror surface, please use specular type sensor head.

The reflected light may be not enough (when the object is mat dark or angled).

- Please try increasing laser power or sampling period so that the sensor head is able to receive enough light reflected.

Measurement data is not updated.

Trigger input may be ON.

When the trigger input is ON, the measurement data won't be updated. Please check "Trigger IN" (Y0A~Y0E).

Hold mode may be activated.

- Please make sure "Qx Hold" is set adequately.

BUSY may be ON.

- Please make sure any "BUSY" (X10~X15) is not ON.

Waveform mode may be activated.

- Please make sure "Head A/B Waveform mode" (Y14, Y15) is not ON.

Measurement result keeps the level "0".

Connection may be broken.

- Please make sure cable and connection is made correctly.

The sensor head not connected may be assigned for the formula.

- The sensor head not connected or receiving data not available may be assigned for the formula. Please make sure all sources of the formula are available.

The operator "*" or "÷" is used in the formula.

- Calculation result could be "0" because of the formula especially by the operator "*" or "÷". Please make sure the formula is built adequately.

Measurement result is not stable.

The number of averaging may be small.

When the number of averaging is smaller, the response speed is faster but the measurement result could be not stable. Please try increasing the number of averaging.

The CD5/CD33 sensor head doesn't match for the application.

The smaller measurement range, the more stable the measurement result will be. Please try sensor head with smaller measurement range.

The measurement result is bigger than what expected.

The sensor head may be tilted from correct position.

- When the sensor head is tilted, the measurement result could be bigger than the measurement result expected. Please check mounting angle of the sensor head.
- Please calibrate the sensor head with gauge or object that you know the exact dimensions. Calibration can be done by setup software.

The measurement result is far different from what expected.

Filtering may be activated.

- High pass or Low pass filter may be activated.
- Please set "Filter choice" (shared memory 29) as OFF and check how it works.

Hold mode may be activated.

- Hold mode may be set as "Peak to Peak hold mode".
- Please check setup of "Qx Hold" (shared memory 33/35/37/39/41).

5.1.3 UQ1 shared memory , X/Y device

Data can't be read from shared memory or updated.

The unit information (slot number, first I/O number) doesn't match to actual PLC unit configuration.

- Please check the setup of unit information (slot number, first I/O number). Please refer [4.5.1 Unit setup] in detail.

Error is ON on UQ1 unit.

- Please check if there is any Error on "Measurement result" screen of setup software or check utilizing GX-Works/GX-Developer. Please try activating "Error release" (Y16) or "Initialize" (shared memory 127) if needed. Refer [4.6.1 Measurement result] in detail.

UQ1 is BUSY.

- Changing setup or storing data into storage may be under process and shared memory data is not available to read. Please check BUSY status at X device and make sure to read shared memory after checking the BUSY is OFF.

Overflow in the calculation.

The formula may not be adequate.

- The calculation result may be overflowing by multiplication with too big number.
- Please check "Overflow" (shared memory 320). You can see what the factor of overflow is.

The receiving data 1/2 is not available.

The slave side UQ1 unit may not be installed next to master side UQ1 unit.

- FirST communication can be done between adjoining UQ1 units installed on Q bus.

There may be blockade between the UQ1 units.

- Please make sure there is no blockade like small slip of paper between the UQ1 units.

The receiving data 1/2 is different from what expected.

FirST setup may be done at master side UQ1 unit.

- FirST setup must be done at slave side UQ1 unit. Please check parameters at slave side UQ1 unit.

Setup changed is not reflected to actual process.

Over writing may not be done.

- Changing on the shared memory won't be reflected by just changing it.
- Please set "Over writing common setup" (Y10) as ON to reflect the setup to actual process. While it's over writing, you can't read shared memory.

Changing Bank is not reflected to actual process.

Over writing may not be done.

- Changing "Bank number" (shared memory 102) won't be reflected by just changing it. Please set "Switching Bank" (Y08) as ON to reflect changing Bank. While changing Bank, you can't read shared memory.

BUSY (X device) status can't be recognized.

BUSY period may be very short.

- BUSY will be ON while UQ1 unit is over writing setup or changing Bank. UQ1 process timing is independent to sequencer scan timing so the sequencer may not be able to recognize the BUSY activated.

5.1.4 Setup software

Setup software can't be installed.

Please make sure to install the software as administrator user.

- When the user mode is not sure, please ask your IT/network manager.

Connection to UQ1 unit can't be done from setup software.

Please make sure there is no problem at communication with PLC and setup on "Set destination" screen.

- Pleaser refer [4.4.1 Set destination] in detail.

Changes on "UQ1-Navigator" doesn't affect actual function

Changes on "UQ1-Navigator" will be applied by clicking "Apply" and  "Store setup parameters". Without this process, any changes won't be applied on actual function.

- Pleaser refer [4.4.1 Set destination] in detail.

Communication error while using setup software.

Please make sure the communication cable is connected correctly and power supply of PLC is connected and ON.

"Set destination", "Read out setup" and "Over write setup" can't be selected.

"Set destination", "Read out setup" and "Over write setup" can't be selected while monitoring measurement result and Waveform.

- Please stop monitoring.

Waveform graph doesn't show (UQ1-02)

Only specular type of CD33 (CD33-Lxx) support Waveform mode.

- Please check sensor type.

The setup software can't be finished.

"Set destination", "Read out setup" and "Over write setup" can't be selected while monitoring measurement result and Waveform.

- please stop monitoring.

5.1.5 Term

Offset

- Offset value is added (subtracted) on (from) measurement result so that you can see the distance from any base position.
- Offset value will be set automatically to show the measurement result as "0" by clicking "Zero reset" button on the setup software.

Update period

- Update period is the timing that UQ1 unit calculate, output and communicate.
- It's rounded out value of actual response speed (shared memory 327) by $100\mu\text{s}$. For example, when the response speed is $140\mu\text{s}$, update period will be $200\mu\text{s}$.

6

Addendum

6.1.1 Cutoff frequency of the filter (UQ1-01)

The cutoff frequency of the filter is defined by "Filter choice" (shared memory 29), "Cutoff frequency" (shared memory 30) and "Sampling period" (shared memory 11, 25). Please refer the cutoff frequency in following table.

Sampling period: 100us		
Cutoff frequency	HPF	LPF
0	650 Hz	2000 Hz
1	350 Hz	800 Hz
2	200 Hz	400 Hz
3	100 Hz	200 Hz
4	50 Hz	100 Hz
5	25 Hz	50 Hz
6	15 Hz	20 Hz
7	10 Hz	10 Hz

Sampling period: 200us		
Cutoff frequency	HPF	LPF
0	325 Hz	1000 Hz
1	175 Hz	400 Hz
2	100 Hz	200 Hz
3	50 Hz	100 Hz
4	25 Hz	50 Hz
5	12.5 Hz	25 Hz
6	7.5 Hz	10 Hz
7	5 Hz	5 Hz

Sampling period: 400us		
Cutoff frequency	HPF	LPF
0	162.5 Hz	500 Hz
1	87.5 Hz	200 Hz
2	50 Hz	100 Hz
3	25 Hz	50 Hz
4	12.5 Hz	25 Hz
5	6.25 Hz	12.5 Hz
6	3.75 Hz	5 Hz
7	2.5 Hz	2.5 Hz

Sampling period: 800us		
Cutoff frequency	HPF	LPF
0	81.25 Hz	250 Hz
1	43.75 Hz	100 Hz
2	25 Hz	50 Hz
3	12.5 Hz	25 Hz
4	6.25 Hz	12.5 Hz
5	3.125 Hz	6.25 Hz
6	1.875 Hz	2.5 Hz
7	1.25 Hz	1.25 Hz

Sampling period: 1600us		
Cutoff frequency	HPF	LPF
0	40.625 Hz	125 Hz
1	21.875 Hz	50 Hz
2	12.5 Hz	25 Hz
3	6.25 Hz	12.5 Hz
4	3.125 Hz	6.25 Hz
5	1.5625 Hz	3.125 Hz
6	0.9375 Hz	1.25 Hz
7	0.625 Hz	0.625 Hz

Sampling period: 3200us		
Cutoff frequency	HPF	LPF
0	20.3125 Hz	62.5 Hz
1	10.9375 Hz	25 Hz
2	6.25 Hz	12.5 Hz
3	3.125 Hz	6.25 Hz
4	1.5625 Hz	3.125 Hz
5	0.78125 Hz	1.5625 Hz
6	0.46875 Hz	0.625 Hz
7	0.3125 Hz	0.3125 Hz

OPTEX
FA **OPTEX FA CO., LTD.**

600-8815 Kyoto, Shimogyo, Chudoji Awata 91, Japan
TEL. +81-(0)75-325-2920 FAX. +81-(0)75-325-2921
<http://www.optex-fa.com>