

IN-SIGHT 2000 SERIES VISION SENSORS

In-Sight® 2000 series vision sensors combine the power of an In-Sight vision system with the simplicity and affordability of a vision sensor. Ideal for solving error-proofing applications, these vision sensors set new standards for value, ease of use and flexibility thanks to a powerful combination of proven In-Sight vision tools, simple setup, and a modular design featuring field-changeable lighting and optics.

Together with the In-Sight Explorer™ EasyBuilder® interface, which provides fast, step-by-step application setup, these vision sensors allow even novice users to achieve extremely reliable inspection performance in nearly any production environment.

In-Sight 2000 series vision sensors can also be configured for in-line and right-angle installation and are available in two form factors. This modular body design provides maximum flexibility to mount in tight spaces, allows for customized wiring and optical paths, and minimizes the need to design new mechanical fixtures.

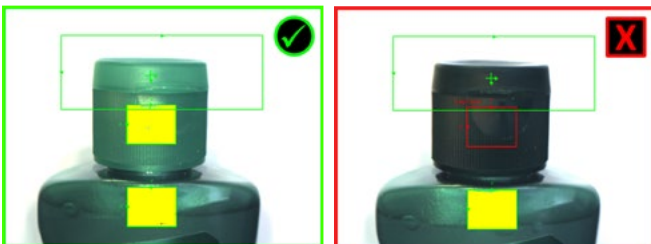
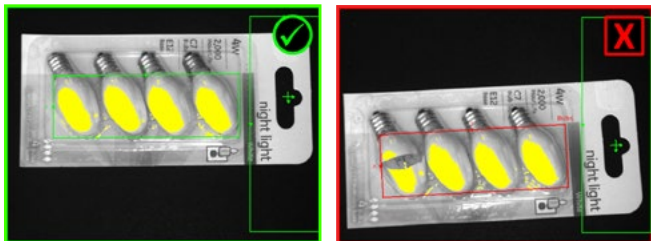
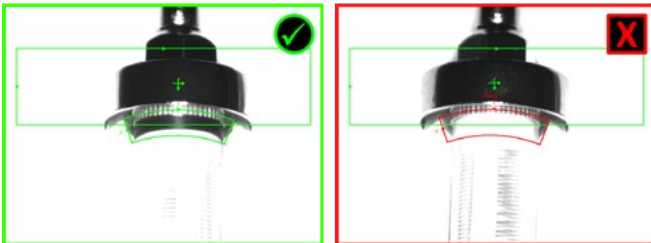
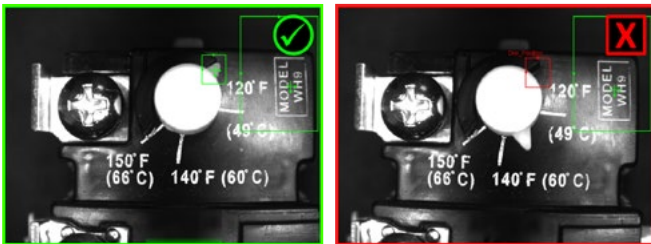

Benefits at-a-glance

- Affordable vision sensor powered by In-Sight Explorer software and EasyBuilder—the same interface used for all In-Sight vision systems
- Simple for both new and existing users to meet their automated inspection challenges
- Monochrome and color sensor models solve presence/absence applications, including color verification
- Proven, reliable Cognex In-Sight vision tools
- Compact, modular design with field-changeable, integrated optics and lighting
- Fully compatible with Cognex VisionView® PC software and VisionView 900 HMI touchscreen panel

Choice of lighting and optics for different application requirements

All In-Sight 2000 series models include an integrated lens and LED illumination that eliminates the need for costly external lighting. Lenses and lighting are field-interchangeable to adjust to different application requirements.

The In-Sight 2000 Mini has a smaller form factor making it ideal for mounting in tight spaces. This model also features an autofocus lens powered by liquid lens technology. This eliminates the need to manually refocus or adjust the mounting height of the sensor during a line changeover.

In-Sight 2000

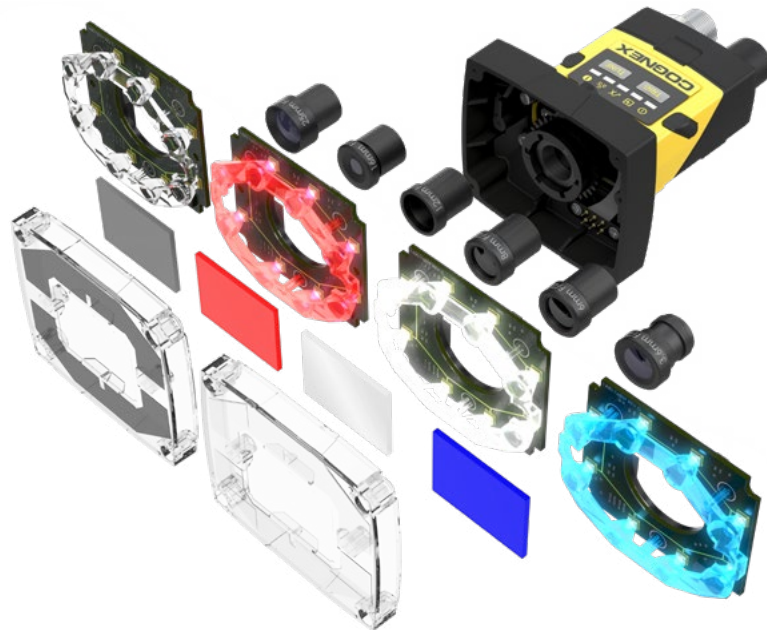

In-Sight 2000 Mini

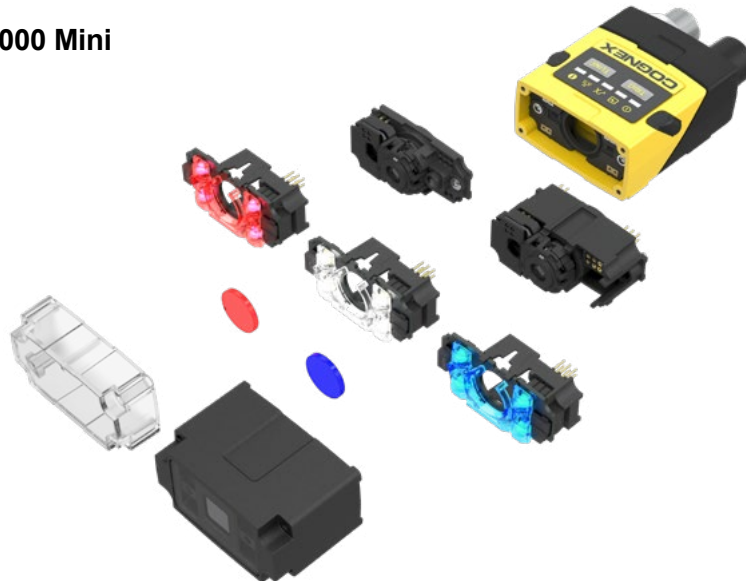

A model for any application

Available in both monochrome and color image models, and with three different combinations of vision tools, the In-Sight 2000 series lets you choose the level of capability you need. Many applications require only the simple pattern matching of the 2000-110 models. The 2000-120 and 2000-130 models offer larger tool sets for solving a wider range of applications, including a 2x magnification mode that delivers greater image detail for inspecting smaller features on parts. Whatever your inspection application, there's an In-Sight 2000 vision sensor model that's right for the job.

Fast, intuitive setup with EasyBuilder

With its intuitive, point-and-click presence/absence tools, the EasyBuilder interface is ideal for setting up simple pass/fail inspections. When more complex inspections are required, users can build on their experience to create vision applications using more advanced In-Sight vision systems—in the same In-Sight Explorer interface.

Simple steps guide you through configuring and deploying your application

Choose tools from the list to add them to your inspection

Name	Result	Type
Flavor	Pass	Pattern
DateLotCode	Pass	Pixel Count
Straw	Pass	Brightness
Seal	Pass	Brightness
LeftFlap	Pass	Contrast
RightFlap	Pass	Contrast

See inspection results at a glance

Point and click controls make it quick and easy to set up any tool to achieve reliable results

A solution for any industry

In-Sight 2000 series vision sensors deliver simple pass/fail results across a wide range of applications in multiple industries. Powerful vision tools deliver robust inspection results for parts in all shapes and sizes. Below, a contrast tool is used to detect the presence of a gasket in an electronics sub-assembly, a pixel count tool is used to identify QA marks on an automotive part, and a color pixel count tool is used to inspect the proper packaging for a fruit snack.

Electronics

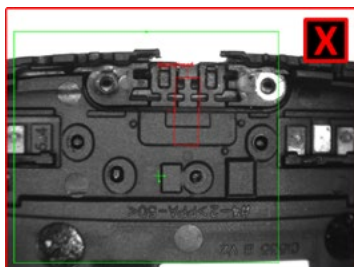
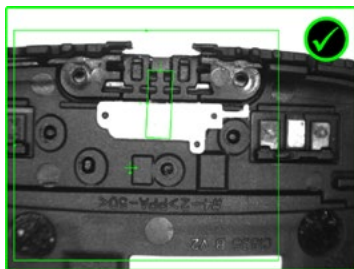

Automotive

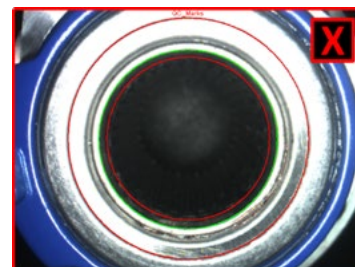
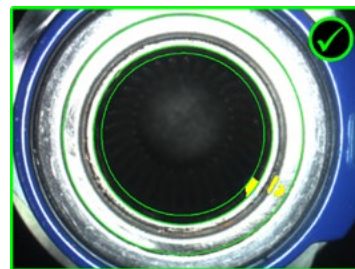

Food and Beverage



IN-SIGHT 2000 MODELS

		2000-110	2000-120	2000-130	2000-120C	2000-130C
User Interface		In-Sight Explorer EasyBuilder, Cognex VisionView PC Software and VisionView 900 HMI touchscreen panel				
1/3" CMOS Imager		Monochrome	Monochrome	Monochrome	Color	Color
S-Mount/M12 Lenses		8 mm (standard), optional 3.6 mm, 6 mm, 12 mm, 16 mm, 25 mm				
Image Modes	640 x 480 (standard)	✓	✓	✓	✓	✓
	640 x 480 (2x magnification)	✗	✓	✓	✓	✓
	800 x 600 (2x magnification)	✗	✗	✓	✗	✓
Lighting	Standard	Diffuse white LED ring light				
	Options	Red, blue and IR LED ring lights and lens filters, and polarized light cover			Polarized light cover	
Maximum Acquisition Speed ¹		40 fps	75 fps	75 fps	55 fps	55 fps
Relative Processing Speed		1x	2x	2x	2x	2x
Location Tools	Pattern	✓	✓	✓	✓	✓
	Edge, Circle	✗	✗	✓	✗	✓
Inspection Tools	Pattern	✓	✓	✓	✓	✓
	Pixel Count	✗	Grayscale	Grayscale	Color	Color
	Brightness & Contrast	✗	✓	✓	✓	✓
	Edges	✗	✗	✓	✗	✓
Measurement & Counting Tools	Distance, Angle & Diameter	✗	✗	✓	✗	✓
	Patterns & Edges	✗	✗	✓	✗	✓
Communications & I/O	Protocols	EtherNet/IP, PROFINET, SLMP, SLMP Scanner, Modbus TCP, TCP/IP, UDP, FTP, Telnet (Native Mode), RS-232				
	Connectors	(1) Industrial M12 Ethernet, (1) M12 Power & I/O				
	Inputs & Outputs	(1) Acquisition trigger, (1) General purpose input ² , (4) General purpose outputs ²				
Mechanical	Dimensions	In-line configuration: 92 mm (3.61 in) x 60 mm (2.38 in) x 52 mm (2.05 in) Right-angle configuration: 61 mm (2.42 in) x 60 mm (2.38 in) x 52 mm (2.05 in)				
	Weight	200 g (7.05 oz)				
	Material and Protection	Painted aluminum, IP65-rated housing				
Operating	Power	24 VDC ±10%, 48 W (2.0 A) maximum when the illumination is on				
	Temperature	0 °C to 40 °C (32 °F to 104 °F)				

¹ Maximum framerate with minimum exposure; no vision tools; and 640 x 480 image with 2x Image Magnification enabled (for 2000-120/130 models)

² (7) general purpose inputs and (8) general purpose outputs when using optional CIO-1400 I/O Expansion Module.

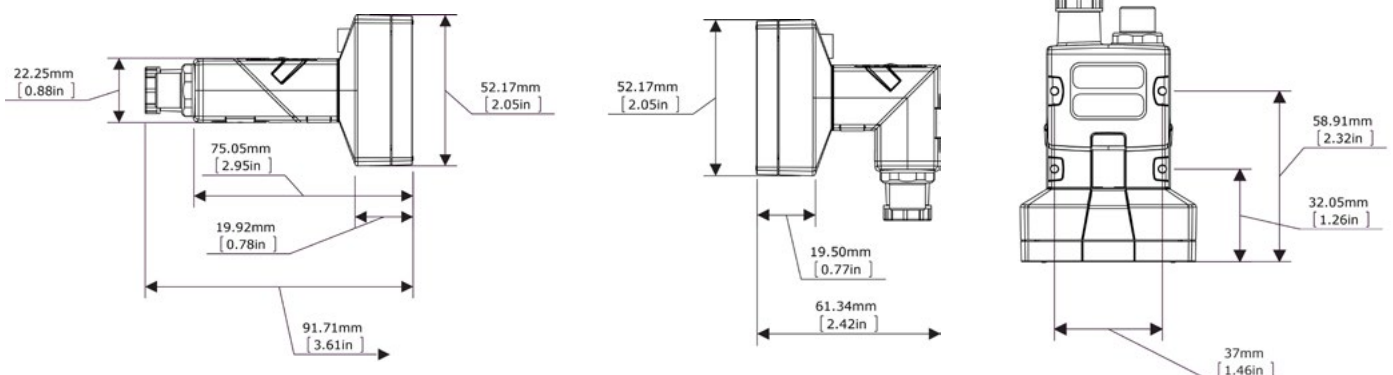

IN-SIGHT 2000 MINI MODELS

		2000-110 Mini	2000-120 Mini	2000-130 Mini	2000-120C Mini	2000-130C Mini
User Interface		In-Sight Explorer EasyBuilder, Cognex VisionView PC Software and VisionView 900 HMI touchscreen panel				
1/3" CMOS Imager		Monochrome	Monochrome	Monochrome	Color	Color
Liquid Lens Autofocus		6.2 mm or 16 mm				
Image Modes	640 x 480 (standard)	✓	✓	✓	✓	✓
	640 x 480 (2x magnification)	✗	✓	✓	✓	✓
	800 x 600 (2x magnification)	✗	✗	✓	✗	✓
Lighting	Standard	Modular red LEDs			Modular white LEDs	
	Options	White, blue & IR LED lights, band-pass filters & polarizing filter			Polarized light cover	
Maximum Acquisition Speed ¹		40 fps	75 fps	75 fps	55 fps	55 fps
Relative Processing Speed		1x	2x	2x	2x	2x
Location Tools	Pattern	✓	✓	✓	✓	✓
	Edge, Circle	✗	✗	✓	✗	✓
Inspection Tools	Pattern	✓	✓	✓	✓	✓
	Pixel Count	✗	Grayscale	Grayscale	Color	Color
	Brightness & Contrast	✗	✓	✓	✓	✓
	Edges	✗	✗	✓	✗	✓
Measurement & Counting Tools	Distance, Angle & Diameter	✗	✗	✓	✗	✓
	Patterns & Edges	✗	✗	✓	✗	✓
Communications & I/O	Protocols	EtherNet/IP, PROFINET, SLMP, SLMP Scanner, Modbus TCP, TCP/IP, UDP, FTP, Telnet (Native Mode), RS-232				
	Connectors	(1) Industrial M12 Ethernet, (1) M12 Power & I/O				
	Inputs & Outputs	(1) Acquisition trigger, (1) General purpose input ² , (4) General purpose outputs ²				
Mechanical	Dimensions	In-line configuration: 43.1 mm (1.69 in) x 22.4 mm (0.88 in) x 64 mm (2.51 in) Right-angle configuration: 43.1 mm (1.69 in) x 35.8 mm (1.40 in) x 49.3 mm (1.94 in)				
	Weight	142 g (5 oz)				
	Material and Protection	Painted aluminum, IP65-rated housing				
Operating	Power	<3.0 W (PoE or external power)				
	Temperature	0 °C to 40 °C (32 °F to 104 °F)				

¹ Maximum framerate with minimum exposure; no vision tools; and 640 x 480 image with 2x Image Magnification enabled (for 2000-120/130 models)

² (7) general purpose inputs and (8) general purpose outputs when using optional CIO-1400 I/O Expansion Module.

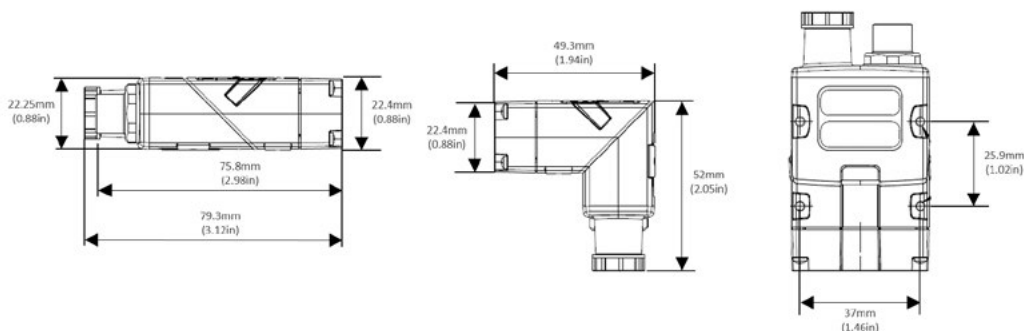

Field of View Diagrams

In-Sight 2000

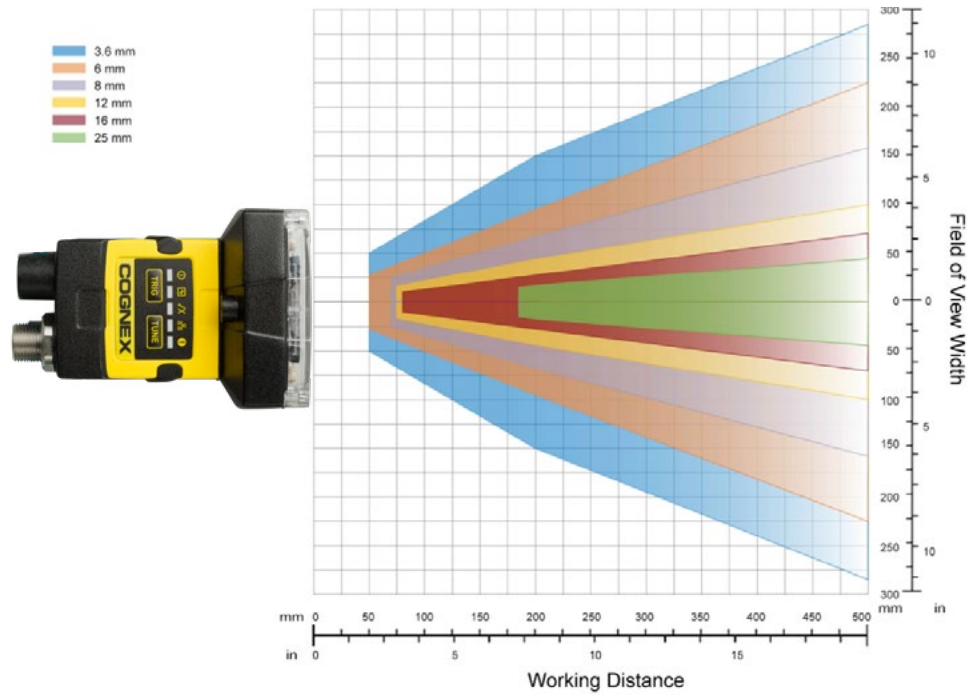

In-Sight 2000 Mini

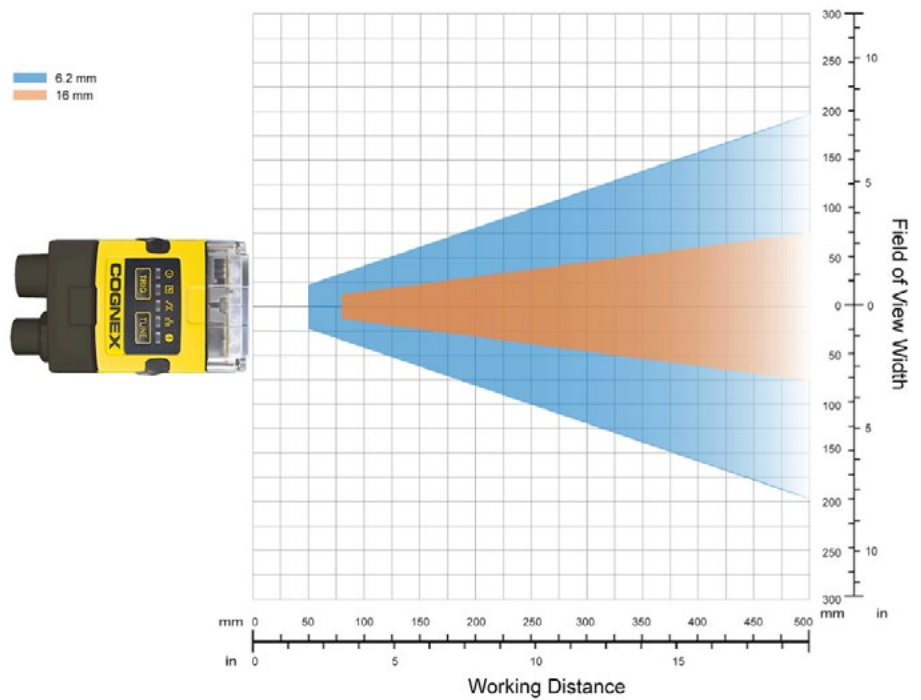

COGNEX

Companies around the world rely on Cognex vision and barcode reading solutions to optimize quality, drive down costs and control traceability.

Corporate Headquarters One Vision Drive Natick, MA 01760 USA

Regional Sales Offices

Americas

North America +1 844-999-2469
 Brazil +55 (11) 2626 7301
 Mexico +01 800 733 4116

Europe

Austria +49 721 958 8052
 Belgium +32 289 370 75
 France +33 1 7654 9318
 Germany +49 721 958 8052

Hungary +36 30 605 5480
 Ireland +44 121 29 65 163
 Italy +39 02 3057 8196
 Netherlands +31 207 941 398
 Poland +48 717 121 086
 Spain +34 93 299 28 14
 Sweden +46 21 14 55 88
 Switzerland +41 445 788 877
 Turkey +90 216 900 1696
 United Kingdom +44 121 29 65 163

Asia

China +86 21 6208 1133
 India +9120 4014 7840
 Japan +81 3 5977 5400
 Korea +82 2 539 9980
 Malaysia +6019 916 5532
 Singapore +65 632 55 700
 Taiwan +886 3 578 0060
 Thailand +66 88 7978924

© Copyright 2017, Cognex Corporation. All information in this document is subject to change without notice. All Rights Reserved. Cognex, In-Sight, EasyBuilder and VisionView are registered trademarks of Cognex Corporation. In-Sight Explorer is a trademark of Cognex Corporation. All other trademarks are property of their respective owners. Lit. No. DSIS2000-11-2017

www.cognex.com