

LFV2-100RD/SW/GR/BL

Model	LFV2-100RD	LFV2-100SW/GR/BL
Voltage	12V DC	24V DC
Power consumption	18W	24W
Mass	980g	980g
Connector type	2P (1: +, 2: -)	3P (1: +, 2: NC, 3: -)

Third Angle Projection Units: mm

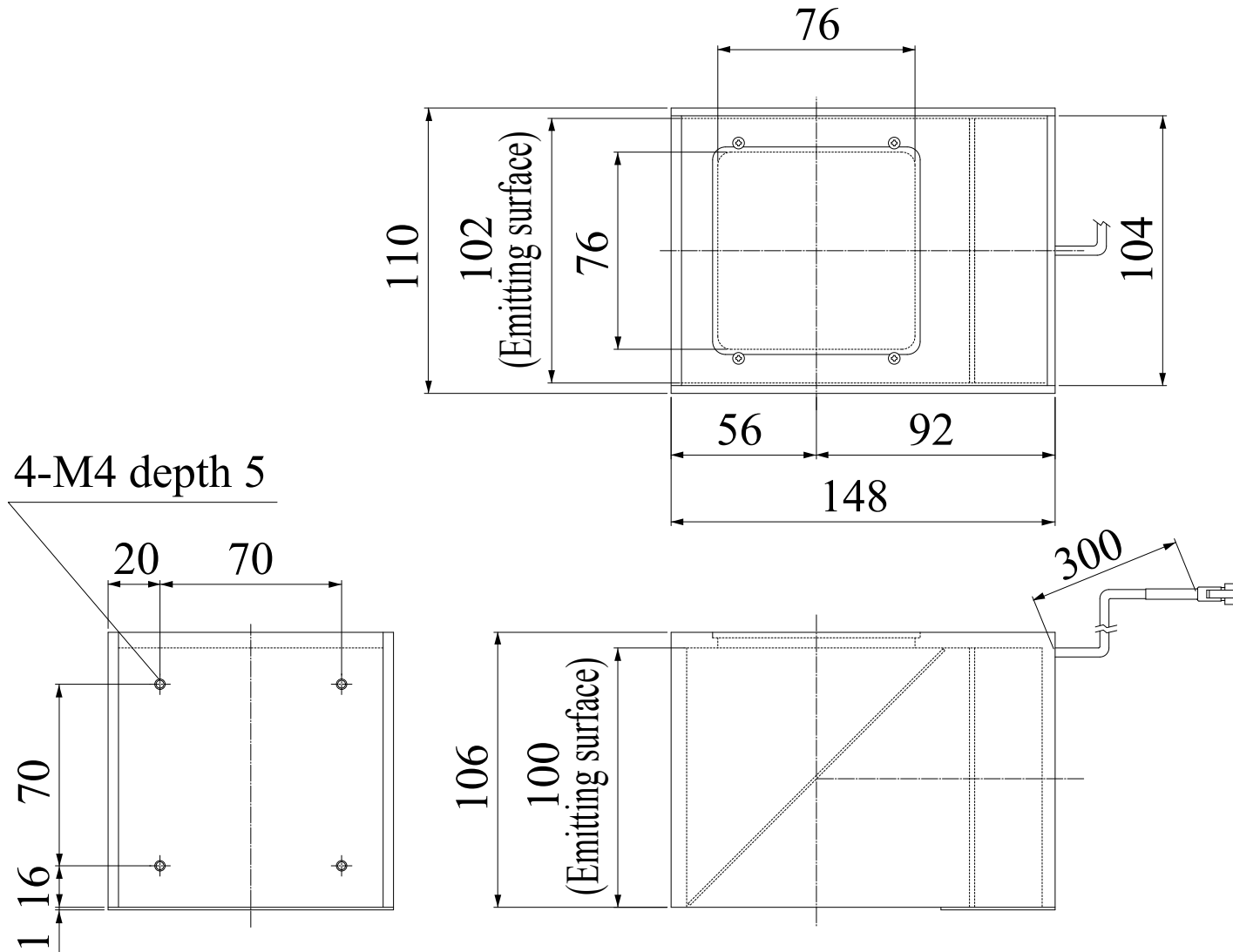



Coaxial Lights / Line Lights with Coaxial System

LFV/LFV2 Series / LNV Series

Even illumination on reflective object surfaces

Bright, even illumination across the entire field of view makes on-axis illumination systems ideally suited for inspecting mirror-finish work for scratches etc.



LFV/LFV2/LFV2-CP Series

LFV2 / LFV2-CP Series

- Use of CCS's unique heat-dissipating structures minimize temperature increases due to the heat generation in LEDs. This increases the intensity stability of the light over time. (See page 71)

LFV / LFV2 / LFV2-CP Series

- Use of a half mirror with anti-reflection coating eliminates ghost images.
- The viewing window is protected with optical glass, preventing the dust entry.
- Co-axial lights with a lens mounting ring are available. These lights can be mounted directly to the threaded part of the lens commonly used for mounting a filter and are best suited for installation in confined places. (available in M25.5, M27, and M30.5 types)

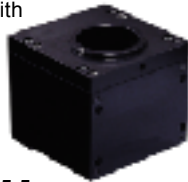

LFV-34-M27

LNV-300

The LNV-300 provides coaxial drop illumination for line sensors. Chip LEDs are used to achieve ultra-even illumination.



LFV2-5 Series

LFV2-5 Series.

- The lens and illumination system are combined in one unit, making the system much easier to use than a separate illumination system combined with a standard f50mm lens.



LFV2-5-5

BGA Alignment Mark Inspection



Magnification / Field of View

	Magnification	L	WD	1/3 in.CCD	1/2 in.CCD
LFV2-5-2	2.4 X	-	28mm or less	Field of View: 1.5mm	Field of View: 2mm
LFV2-5-5	1.1 X	0mm	45mm or less	Field of View: 3.2mm	Field of View: 4.2mm
LFV2-5-5	3 X	70mm	23mm or less	Field of View: 1.2mm	Field of View: 1.6mm
LFV2-5-12	1 X	0mm	22mm or less	Field of View: 3.5mm	Field of View: 4.6mm
LFV2-5-12	0.4 X	20mm	53mm or less	Field of View: 9.3mm	Field of View: 12.2mm

Product Lineup Table

Series	Model Name	Color	Power Consumption	Options	Dimension	
LFV	LFV-34	●	12V/2.9W	—	1	
	LFV-34-SW-GR-BL	○/●/●	24V/2.4W	—	1	
	LFV-34-M25	●	12V/2.9W	—	2	
	LFV-34-M27	●	12V/2.9W	—	2	
	LFV-34-M30	●	12V/2.9W	—	2	
	LFV-40	●	12V/2.4W	—	3□	
LFV2	LFV2-35RD	●	12V/2.4W	P-L	4□	
	LFV2-35SW/GR/BL	○/●/●	24V/3.3W	P-L	4□	
	LFV2-50RD	●	12V/6.6W	P-L	5□	
	LFV2-50SW/GR/BL	○/●/●	24V/9.0W	P-L	5□	
	LFV2-70RD	●	12V/9.3W	P-L	6□	
	LFV2-70SW/GR/BL	○/●/●	24V/14W	P-L	6□	
	LFV2-100RD	●	12V/18W	P-L	7	
	LFV2-100SW/GR/BL	○/●/●	24V/24W	P-L	7	
	LFV2-CP	LFV2-130RD	●	12V/28W	P-L	8
		LFV2-130SW/GR/BL	○/●/●	24V/41W	P-L	8
LFV2-200RD		●	24V/42W	P-L	9□	
LFV2-200SW/GR/BL		○/●/●	24V/46W	P-L	9□	
LFV2-CP-13RD		●	12V/0.9W	—	10□	
LFV2-CP-13SW/GR/BL		○/●/●	12V/0.7W	—	10□	
LFV2-CP-18RD		●	12V/1.2W	—	11	
LFV2-CP-18SW/GR/BL		○/●/●	24V/1.6W	—	11	
LFV2-CP-18RD-M27		●	12V/1.2W	—	12	
LFV2-CP-18RD-M30		●	12V/1.2W	—	12	
LFV2-5	LFV2-5-2RD	●	12V/1.2W	—	13	
	LFV2-5-5RD	●	12V/1.2W	—	14	
LNV	LFV2-5-12RD	●	12V/1.2W	—	15	
	LNV-300	●	24V/5.4W	—	16	
	LNV-300-SW-GR-BL	○/●/●	24V/10W	—	16	

*1: The Series listed here includes "SW2", white light with higher light intensity than "SW (white light)". Please contact us for more details.

Dimensions (Unit: mm)

Illumination structure of LFV

A half mirror aligns the high-intensity, even light from the LED array to the same optical axis as the lens.

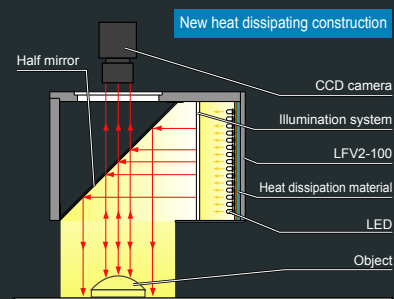

Example of Coaxial Illumination Images

Inspecting for Bearing Face Damage
Even small scratches are made clearly visible, using an on-axis illumination system.



Bearing Periphery Inspection
With standard coaxial illumination, the light is concentrated at the center of the illumination area.

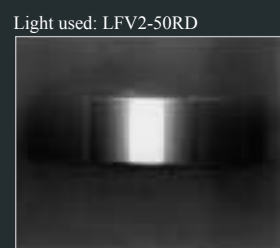

With the LNV-300, even lumination is achieved over a wide area.

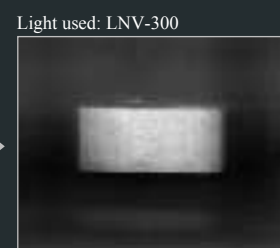

Luminosity Characteristics of the LFV-34

Below is x and y axis characteristics for a typical LFV coaxial light. As can be seen, it provides an extremely uniform light distribution in both axes. In addition, the light may be collimated by using LC film filter

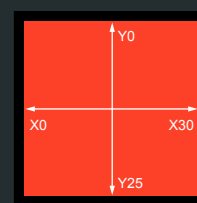

Luminosity change in the x direction

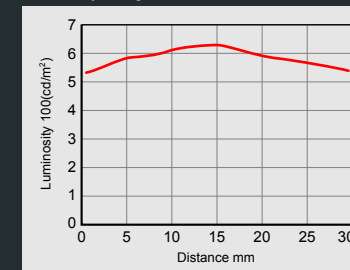

Luminosity change in the y direction

