

LFX-100RD

Model name	LFX-100RD
LED color	Red
Input voltage	24VDC
Power consumption	4.8W
Weight	370g
Connector	SMR-03V-B
Polarity and signal	1: (+), 2: NC, 3: (-)

Third Angle Projection Units: mm

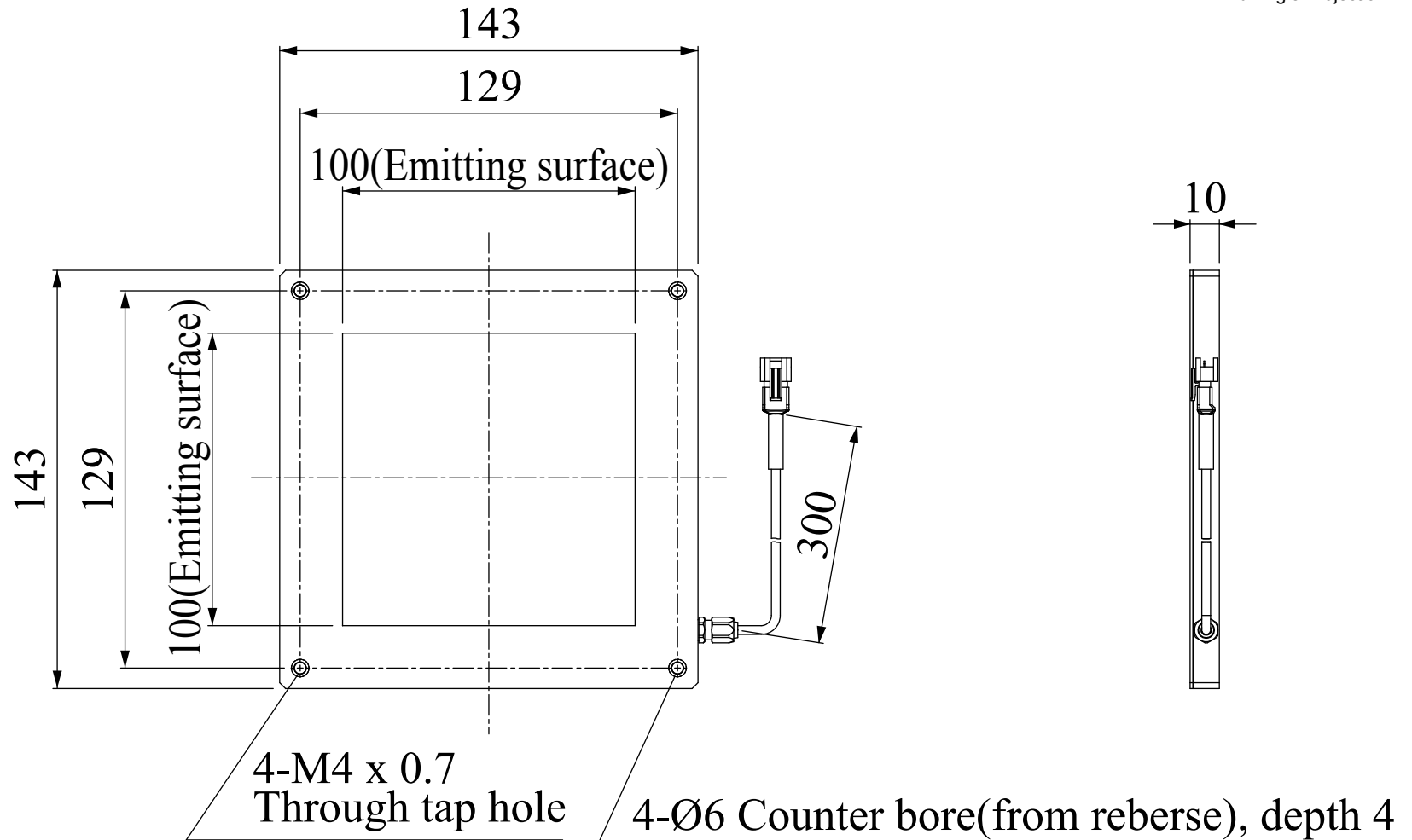

Specifications

Series	LFX2-50 Series			LFX2-75 Series			LFX2-100 Series			LFX2-150 Series			LFX2-200 Series		
Model	LFX2-50RD	LFX2-50SW	LFX2-50IR850	LFX2-75RD	LFX2-75SW	LFX2-75IR850	LFX2-100RD	LFX2-100SW	LFX2-100IR850	LFX2-150RD	LFX2-150SW	LFX2-150IR850	LFX2-200RD	LFX2-200SW	LFX2-200IR850
Direct number	1004156	1004160	1004164	1004157	1004161	1004165	1004158	1004162	1004166	1004159	1004163	1004167	1004115	1004116	1004117
LED color	Red	White	Infrared	Red	White	Infrared	Red	White	Infrared	Red	White	Infrared	Red	White	Infrared
Emitting surface size	50×50 mm			75×75 mm			100×100 mm			150×150 mm			200×200 mm		
Input voltage	24 VDC														
Power consumption	11 W	6.1 W	6.6 W	11 W	9.1 W	14 W	16 W	13 W	14 W	21 W	19 W	20 W	31 W	25 W	27 W
Peak wavelength (typ.) / corresponding color temperature (typ.)	635 nm	6600 K	850 nm	635 nm	6600 K	850 nm	635 nm	6600 K	850 nm	635 nm	6600 K	850 nm	635 nm	6600 K	850 nm
Case materials	Aluminum alloy and PMMA														
Cable	2-conductor cable, 0.3 m (+35 mm, -0 mm)														
Connector	SMR-03V-B														
Polarity, signal	1: Anode (+), brown; 2: NC; 3: Cathode (-), blue														
Cooling method	Natural air cooling														
Operating temperature and humidity	Temperature: 0 to 40°C, humidity: 20% to 85%RH (with no condensation)														
Storage temperature and humidity	Temperature: -20 to 60°C, humidity: 20% to 85%RH (with no condensation)														
Weight	Approx. 180 g			Approx. 270 g			Approx. 350 g			Approx. 570 g			Approx. 920 g		

Notes:

- LFX2 Flat-Dome Lights cannot be used together with a PTU2-3024, BB-V24S30-M, or BB-V24S30-S Strobe Power Supply (over drive) from CCS.
- ON/OFF lighting control is possible with a PD2-series or BB-series, CC-ST-1024 Constant Lighting Power Supply.
- The wavelengths are different from the previous models. Refer to the specular distribution diagram at the right.
- The peak wavelength for Red Lights is 635 nm. If a Sharp-cut Filter is required, use a R60 Filter (optional).

Direct Numbers:

A direct number is a 7-digit number assigned to a CCS product. You can easily access the web page providing information on any desired product by simply entering the direct number in the space provided on the CCS website pages for machine vision. For details: http://www.ccs-grp.com/s6_common/direct.html

■ Specular Distribution Diagram

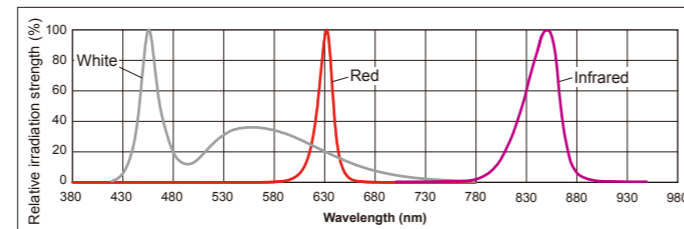

Dimensional Diagrams (mm)

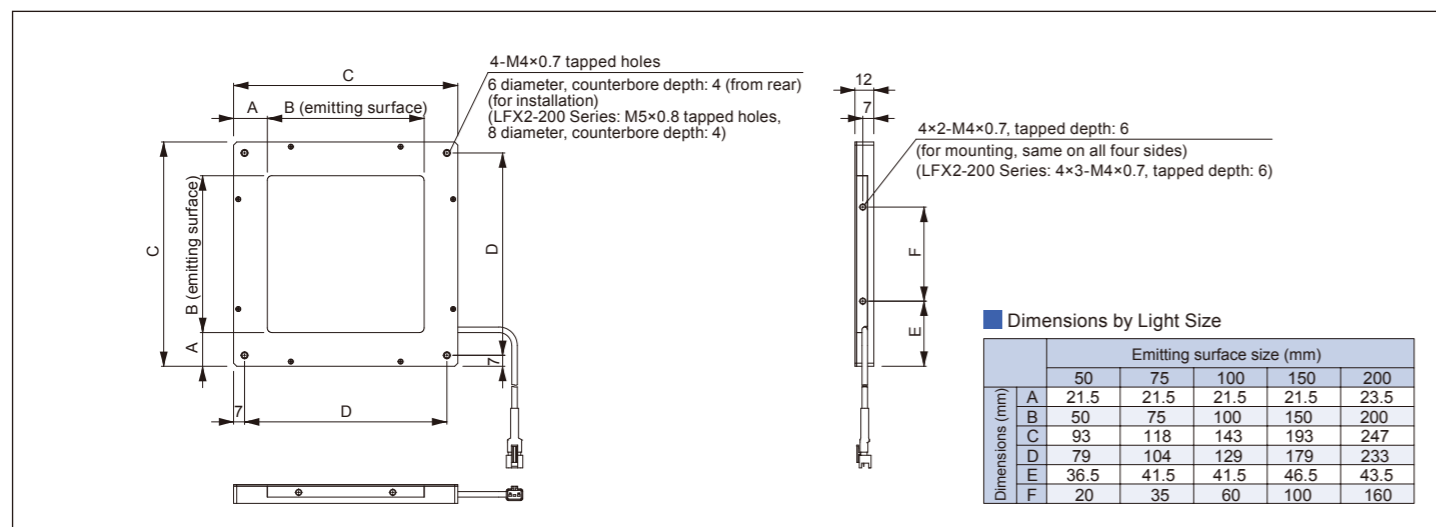

Notes:

- Carefully read the product's instruction manual before use to ensure correct operation.
- Product specifications and design are subject to change without notice.
- Examples of workpiece imaging in this catalog are a guide that may be informative for choosing illuminations. Please check the functions of the equipment and requirements when choosing.

High-output Flat-Dome Light The NEW LFX2 Series

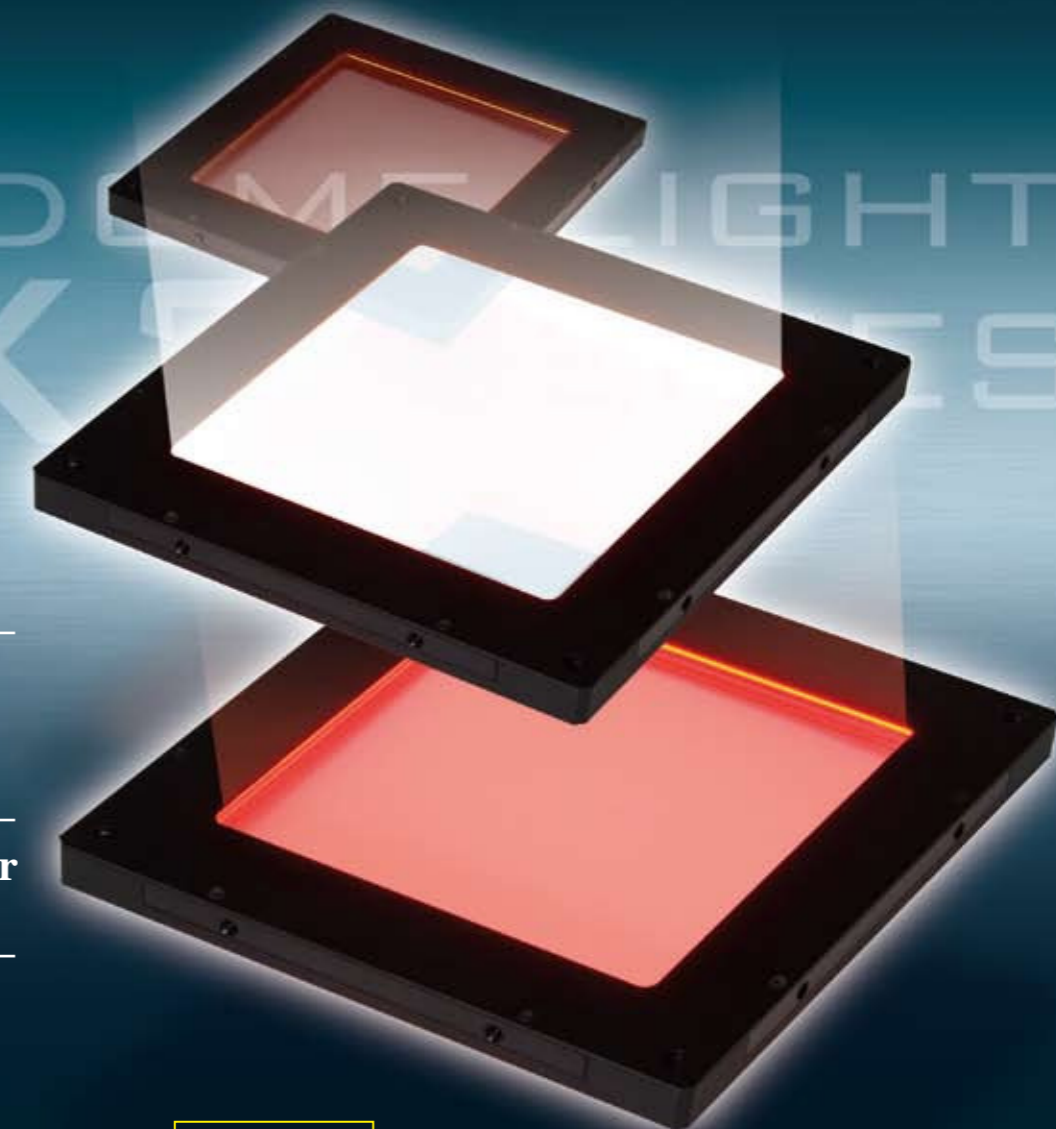

Higher output for
high-speed
inspections.

Infrared light for
a wide range
of applications.

A Complete Lineup for
Ideal Imaging

- Emitting Surface Size
50×50 mm, 75×75 mm,
100×100 mm, 150×150 mm,
200×200 mm
- LED Colors
Red, white, and infrared

NEW

FLAT DOME LIGHTING **LFX2** SERIES

CCS Inc.

Headquarters

Shimodachiuri-agaru, Karasuma-dori, Kamigyo-ku, Kyoto 602-8011 Japan
Phone: +81-75-415-8284 / Fax: +81-75-415-8278
URL: <http://www.ccs-grp.com> E-mail: intlsales@ccs-inc.co.jp

LFX2 Flat-Dome Light Advantages

Higher output for high-speed inspections

Brighter

Compared to previous models, the light is approximately 4 times brighter for red light and approximately 3 times brighter for white light at the camera output.

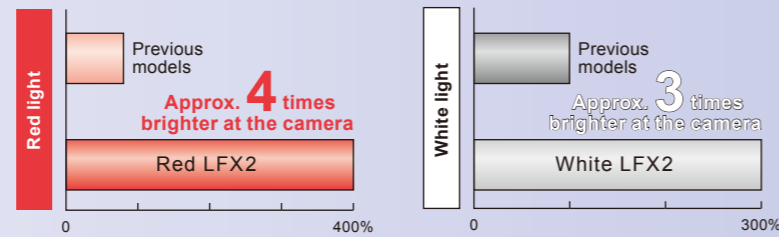

Notes: 1) The brightness depends on the spectral sensitivity characteristics of the camera.
2) The graphs provided in this pamphlet are for reference only. They do not guarantee product quality.

The LFX2 Series enables bright imaging for applications that could not be handled with the lower output of previous models.

Image Comparison with Previous Models (Red Light)

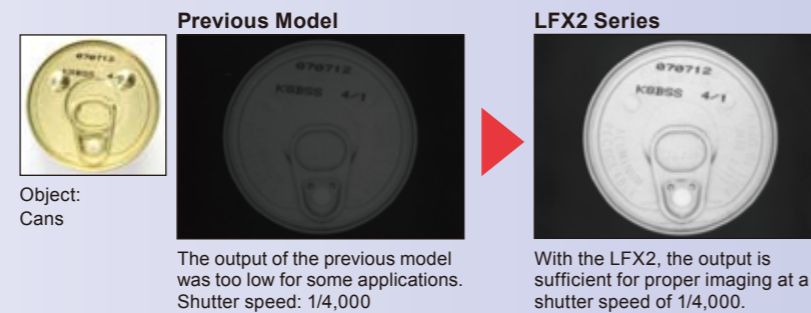

Notes: 1) The brightness depends on the spectral sensitivity characteristics of the camera.
2) The sample objects that are used were purchased and prepared by CCS, and are not intended to represent actual quality and performance.

Infrared light for a wide range of applications

Infrared Lights

Use these lights for a wide range of applications from visible light to invisible infrared light.

The peak wavelength for Infrared lights is 850 nm.

Imaging Comparison with Red Light

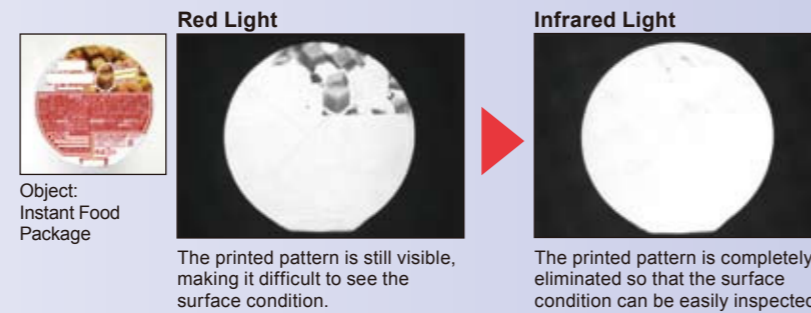

Note: The sample objects that are used were purchased and prepared by CCS, and are not intended to represent actual quality and performance.

A Complete Lineup for Ideal Imaging

Complete Lineup

Models are available with five emitting surface sizes: 50, 75, 100, 150, and 200 mm. Select red, white, or infrared light.

- Emitting Surface Size
50×50 mm, 75×75 mm, 100×100 mm, 150×150 mm, 200×200 mm
- LED Colors
Red / White / Infrared

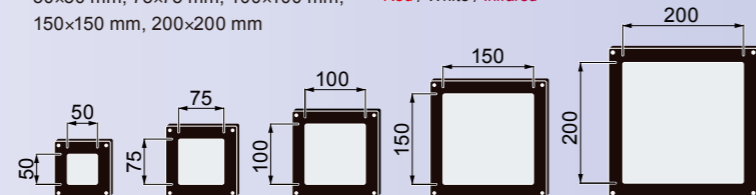

The LFX2 Flat-Dome Light

can be used for wide range of applications in many different fields.

High Output to be compatible with High-speed Cameras; New Infrared Lights for Even More Applications

Application Examples in Packaging

Missing part inspections
+
Foreign object inspections



The products are uniformly lit without showing the printed pattern on the packages.
Object
Product packs containing 4 products
Light Used
LFX2-200RD (red)

Application Examples in Food Industry

Foreign object inspections

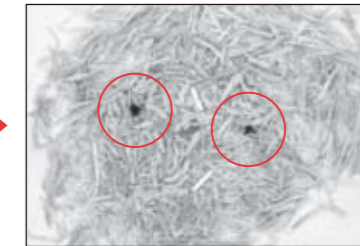

Light is transmitted through tea leaves to detect only foreign objects.
Object
Tea leaves
Light Used
LFX2-200IR850 (infrared)

Application Examples in Pharmaceuticals

Fault inspections



The surface is uniformly lit to inspect the edge or overlap of transparent film.
Object
Throat lozenges
Light Used
LFX2-200RD (red)

Note: The sample objects that are used were purchased and prepared by CCS, and are not intended to represent actual quality and performance.

Obtaining the Quality Image

1 The dot pattern in the emitting surface can produce inconsistent images.

Reducing inconsistent images produced by dot patterns

1. Open the lens aperture slightly.
2. Focus on the object precisely.
3. Adjust the height of the Light. (Install it outside the focal depth.)
4. Adjust the light intensity. (Suppress reflections and shining.)
5. If the light is too bright, increase the shutter speed of the camera.

2 Ambient light can reflect from the surface of the Light or object, which can affect the captured image.

Preventing the effects of ambient light

1. Install a hood or otherwise to block the ambient light.
2. For red light, mount a Sharp-cut Filter on the lens.
3. Increase the shutter speed of the camera. (Close the lens aperture slightly.)

Application Precautions

The captured image can be affected by dirt and dust on the surface of the Light.

Preventing the Effects of Dirt and Dust

- Handle the Light carefully to keep it clean from dirt, dust, and fingerprints.
- If the Light becomes contaminated with fingerprints, wipe them off with a fine, soft cloth.
- Do not wipe off dirt or dust with your fingers. Blow them off with air.
- If the Light becomes very dirty, wipe it off lightly with a thin solution of neutral detergent.

Luminescent spots may result from foreign matter in the emitting surface. These are within CCS inspection standards and do not indicate faults in the product.

Flat-Dome Light LFX2 Series Instruction Guide

Thank you for purchasing a CCS product. To ensure proper use of the product, please read this Instruction Guide before use and keep it for your future reference.

1. Introduction

This product is an LED light used for machine vision and industrial inspection. Do not use the product for other applications, and be sure to follow the instructions below.

- Do not use the product in the following situations.
 - Under conditions or in an environment not described in this Instruction Guide.
 - In nuclear energy control systems, railroad systems, aviation systems, vehicles, combustion equipment, medical equipment, amusement machines, or safety equipment.
 - In applications involving serious risk to life or property, particularly applications demanding a high level of safety.

- Use the product only in the following environment.

Operating environment (indoors only)	Temperature: 0 to 40°C, Humidity: 20 to 85%RH (with no condensation)
Storage Environment	Temperature: -20 to 60°C, Humidity: 20 to 85%RH (with no condensation)

- Please install products to locations with following conditions. Incorrect installation location may cause product failure.

- In a flat and stable location with minimal vibration.
- Well-ventilated places with minimal dust.
- Places that are not subject to sudden temperature changes.
- Places that can be electrically insulated.
- Places free from any water, oil, liquid, chemical, or steam.
- Places free from corrosive or combustible gas.
- Places away from water faucets, boilers, humidifiers, air conditioners, heaters, or stoves.

- Laser Safety Standards (IEC60825-1 Amd.2)

LED illumination devices are laser products as stipulated by IEC (International Electrotechnical Commission) and JIS (Japanese Standards Association). A brief summary of the hazard classes is provided below.

Note: Before using Infrared LED Lights, read the enclosed Handling Precautions for Infrared LED Lights.

Class	Outline of risk evaluation
Class 2	Low-output visible light (400 to 700 nm): The eyes are generally protected by an aversion reaction, such as blinking.

- Model Number Confirmation

LED color	Red	White	Infrared
50mm	LFX2-50RD	LFX2-50SW	LFX2-50IR850
75mm	LFX2-75RD	LFX2-75SW	LFX2-75IR850
100mm	LFX2-100RD	LFX2-100SW	LFX2-100IR850
150mm	LFX2-150RD	LFX2-150SW	LFX2-150IR850
200mm	LFX2-200RD	LFX2-200SW	LFX2-200IR850

-1-

2. Important Information for Equipment Safety -Read Before Use-

Incorrect usage of the product may result in fire, electric shock, or other serious damages. Please ensure to follow the conditions below.

- The following symbols are used in this instruction guide to indicate and classify the relative importance of warnings and cautions.

	Indicates that incorrect usage may result in serious injury or death.		Indicates that incorrect usage may result in injury or property damage.
--	---	--	---

- The following symbols in the instruction guide indicate and classify the precautions.

These symbols mean the prohibited action.				These symbols mean the necessary action must obey.

Warning	
Do not disassemble or modify the product. Doing so may result in fire or electric shock.	
Do not touch the product with wet hands. Doing so may result in electric shock.	
Make sure that the product is free of moisture or any liquid. Exposure to water may result in fire, electric shock, or product failure.	
Connect or disconnect the light cable only after turning off the power supply for the LED light. Failure to do so may result in circuit damage, fire caused by a minute spark, or electric shock.	
If abnormal condition occurs such as fuming, heat, smell, noise, or so on, stop using the product immediately, and turn the power off. A fire or electric shock may result if the product is kept used.	

Caution	
Do not use user-made cables. Doing so may cause product failure. Use the optional extension cable if it is necessary to extend the distance between the light and the power supply.	
Be careful of static electricity. Damage to the LED light may occur, if a person charged with static electricity touches it. Keep the product away from all items charged with static electricity.	
Do not drop the product or subject it to impact. Doing so may cause the product to malfunction.	
Make sure that the length of the extension cable is less than 5m. If the extension cable is longer than 5m, the voltage applied to both ends of the LED light will drop due to the DC resistance of the cable. The rated voltage will not be attained for 100% radiant ability, and the radiant quantity will drop as a result.	

Note: Before using Infrared LED Lights, read the enclosed Handling Precautions for Infrared LED Lights.

-2-

3. Wire Connection

- Make sure that the power supply for the LED light is turned off.
 - Note: Read the instruction guide of the power supply for the LED light before use.
- Refer to the illustration below and connect the light cable to the power supply output connector.
- Connect power cord to inlet and wall socket.

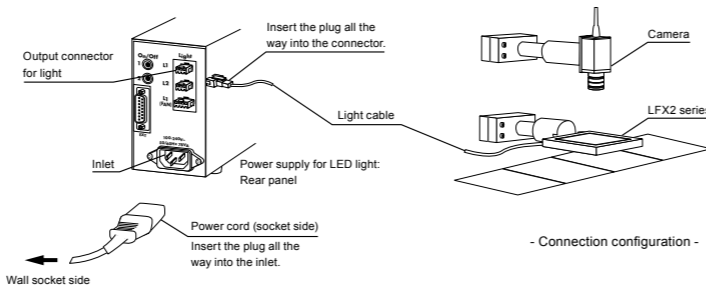

4. Operating Instructions

This product has both dome illumination and coaxial illumination characteristics. To obtain the optimum images, refer to the following.

- Characteristics for Dome Illumination

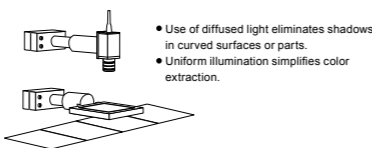

- Characteristics for Coaxial Illumination

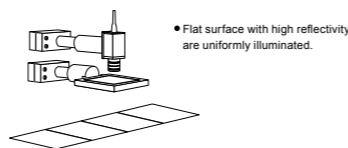

Recommended Applications

Categories	Recommendation	Applications
Visual inspection		Inspecting the appearance of curved, irregular, or flat glossy objects (detecting scratches, dirt, scorching, breaking, or chipping, distinguishing different shapes and presence/absence, inspecting surface conditions)
Character recognition		Character recognition on glossy objects. Bar codes and 2-dimensional codes.
Measurement		Dimensional measurement (when high precision is not required)

••• Optimal ••• Suitable ••• Usable

-3-

Preparation to capture images

- Turn on the power supply for the LED light.
- Focus the imaging device, such as a camera, onto the inspection object.
- Adjust light range, light angle, and radiant quantity to optimize images.

Note: When using white LED lights with color image processing equipment, readjust the white balance for the camera approximately 60 minutes after turning on the power.

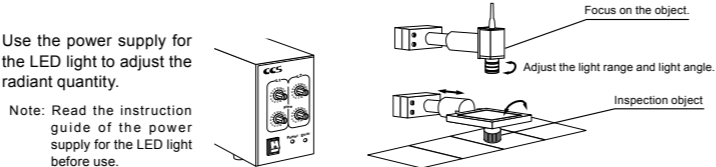

- Imaging example -

To obtain the optimal image

- Image irregularities and moiré may occur due to the dot pattern on the light guide diffuser.

*moiré: A periodic stripe pattern made as a result of mutual interference between the geometric dot pattern of the lighting and the pixel pattern of the CCD.

- How to decrease image irregularities and luminescent spots caused by the dots

- Open the F-stop as much as possible.
- Bring the inspection object into focus.
- Adjust the position of the light. (set outside of the focal depth)
- Adjust the radiant quantity. (control reflection and shining)
- Use a shorter exposure time and adjust the radiant quantity.

Note: Luminescent spots may result from foreign matter contained in the light guide diffuser, but these are within the CCS inspection range and do not constitute a malfunction.

- When the ambient light is reflected from the surface of the light or the surface of the object, the captured image may be affected.

- Methods for preventing the effects of ambient light

- Attach a sharp-cut filter. (effective for red light)
- Make the exposure time of camera shorter and adjust the radiant quantity.
- Prevent the entry of glare by shroud.

- Dirt or dust on the surface of the light may affect the captured image.

- Dirt and dust removal methods

- Handle the light with care. Make sure no dirt, dust, or fingerprints get on the light.
- Remove dirt and dust by blowing air rather than by hand.
- Use a soft, finely woven cloth to wipe away any marks such as fingerprints.
- Use diluted neutral detergent to remove any heavy dirt.

-4-

- Efficient Use of LED Lights

LED lights generate heat that decreases radiant quantity and speeds degeneration. Follow the instructions below in order to suppress the heat of LED lights and prevent decreases radiant quantity and speeds degeneration.

- Use the light with the light level turned as low as possible.
- Only turn light on during imaging.
- Installing a fan or providing air flow for heat dissipation.

6. Power Supply

When connecting a power supply to this product, use following CCS Power Supply Units for the LED light. Select a power supply to match the application and purpose. When making the selection, confirm that the total power consumption of the connected lights will be within the power supply output power specifications. Read the Instruction Guide of the power supply for the LED light before use.

- Digital Power Supply (Pulse duty control)

The digital power supply is able to control radiant quantity with a PWM light control system.

- Analog Power Supply (Constant voltage control)

The analog power supply providing stepless intensity control through variable voltage control.

Note: This product does not support overdrive power supplies.

Please contact CCS Inc. about an other power supply.

6. Specifications

- LFX2-50 series

Model	LFX2-50RD	LFX2-50SW	LFX2-50IR850
Power consumption (max.)	11W	6.1W	6.6W
LED color	Red	White	Infrared
Peak wavelength (typ.)	635nm	-	850nm
Weight (max.)	180g		

- LFX2-75 series

Model	LFX2-75RD	LFX2-75SW	LFX2-75IR850
Power consumption (max.)	11W	9.1W	14W
LED color	Red	White	Infrared
Peak wavelength (typ.)	635nm	-	850nm
Weight (max.)	270g		

- LFX2-100 series

Model	LFX2-100RD	LFX2-100SW	LFX2-100IR850
Power consumption (max.)	16W	13W	14W
LED color	Red	White	Infrared
Peak wavelength (typ.)	635nm	-	850nm
Weight (max.)	350g		

- LFX2-150 series

Model	LFX2-150RD	LFX2-150SW	LFX2-150IR850
Power consumption (max.)	21W	19W	20W
LED color	Red	White	Infrared
Peak wavelength (typ.)	635nm	-	850nm
Weight (max.)	570g		

- LFX2-200 series

Model	LFX2-200RD	LFX2-200SW	LFX2-200IR850
Power consumption (max.)	31W	25W	27W
LED color	Red	White	Infrared
Peak wavelength (typ.)	635nm	-	850nm
Weight (max.)	920g		

- Common Specifications

Input voltage	24V DC
Polarity and signal	1(+), 2.NC, 3(-)
Case material	Aluminum alloy, PMMA

7. Dimensional diagrams (mm)

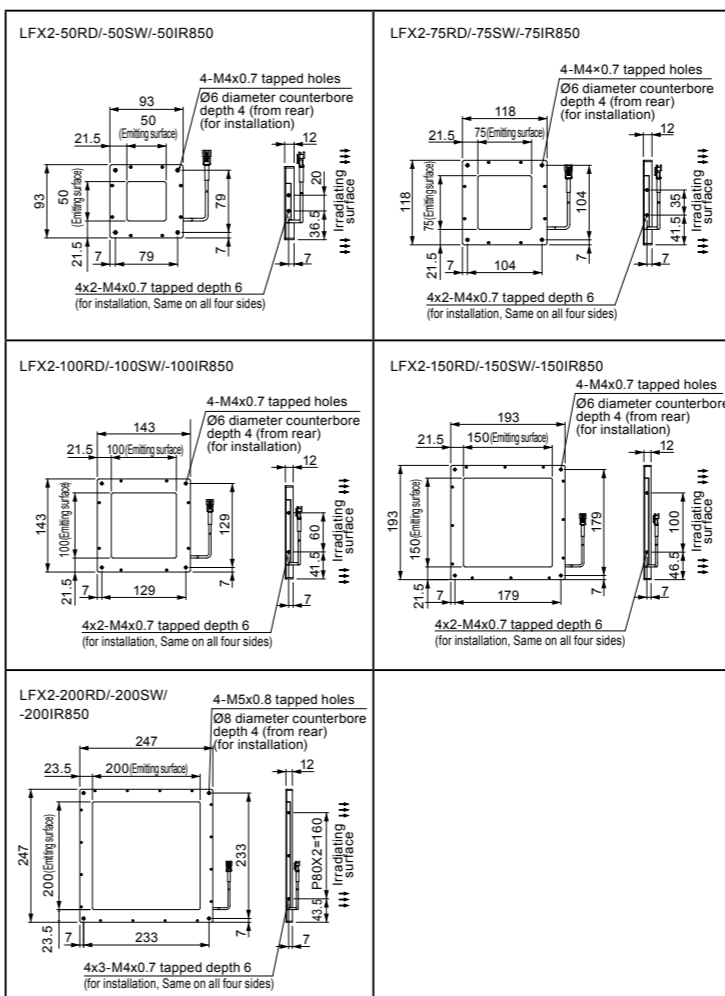

-6-

8. EU RoHS Directive

The RoHS Directive is short for the "restriction of use of certain hazardous substances in electrical and electronic equipment." As a directive, it restricts the use of specific hazardous substances for new electrical and electronic equipment marketed in the EU on or after July 1, 2006, and restricts the use of six substances, which are (1) lead, (2) mercury, (3) cadmium, (4) hexavalent chromium, (5) polybrominated biphenyl (PBB), and (6) polybrominated diphenyl ether (PBDE).

*Standards for "RoHS Directive-Compliant Products"

Lead	Mercury	Cadmium	Hexavalent chromium	PBB	PBDE
1000ppm Min	1000ppm Min	100ppm Min	1000ppm Min	1000ppm Min	1000ppm Min

(Items that are exempted in the RoHS Directive are excluded from these standards.)

9. China RoHS Directive

China RoHS Directive is formally known as "Management Methods for Controlling Pollution by Electronic Information Products", which was implemented on March 1, 2007 in China. Same as EU RoHS Directive, this regulation restricts the usage of six substances such as lead, mercury, cadmium, hexavalent chromium, polybrominated biphenyl (PBB), and polybrominated diphenyl ether (PBDE). This regulation requires electronic information products which are manufactured or imported, and sold in China, to clearly disclose contents of the 6 restricted substances listed below.

Usage Deadline for Environmental Protection	Product name	Toxic or Hazardous Substances and Elements					
		Lead (Pb)	Mercury (Hg)	Cadmium (Cd)	Hexavalent chromium (Cr(VI))	PBB	PBDE
	LED Lights	×	○	×	○	○	○

○ Indicates that this toxic or hazardous substances contained in all the homogeneous materials for this part, according to SJ/T11363-2006 is within the limit requirement.
 × Indicates that this toxic or hazardous substance contained in all the homogeneous materials for this part, according to SJ/T11363-2006, is over the limit requirement.
 *Lead and cadmium are excluded in EU RoHS.

Usage deadline for environmental protection
 The number used in this logo is based on "Management Methods for Controlling Pollution by Electronic Information Products" and related regulations from People's Republic of China. It shows the product usage duration in years for environmental protection. After finishing a product usage, the product need to be re-used or discard appropriately following local law and regulations, complying with safety and usage caution.

环保使用期限	产品	产品中有毒有害物质或元素的名称及含量					
		铅 (Pb)	汞 (Hg)	镉 (Cd)	六价铬 (Cr(VI))	多溴联苯 (PBB)	多溴二苯醚 (PBDE)
	LED 照明	×	○	×	○	○	○

○: 表示该有毒有害物质在该部件所有均质材料中的含量均在 SJ/T11363-2006 标准规定的限量要求以内。
 ×: 表示该有毒有害物质至少在该部件的某一均质材料中的含量超出 SJ/T11363-2006 标准规定的限量要求。
 (注) 铅和镉中的 "×", 因欧洲 RoHS 没限定, 故用 "○" 表示。

环保使用期限
 此标志的数字是根据中华人民共和国电子信息产品污染控制管理办法以及有关标准等, 表示该产品的环保使用期限的年限。遵守产品的安全和使用上的注意, 在产品使用后采取适当的方法根据各地法律, 规定, 回收再利用或进行废弃处理。

-7-

Warranty Information

EXCEPT FOR THE EXPRESS WARRANTIES STATED IN THIS AGREEMENT, COMPANY MAKES NO ADDITIONAL WARRANTIES, EXPRESS, IMPLIED, OR STATUTORY, AS TO ANY MATTER WHATSOEVER. IN PARTICULAR, ANY ALL WARRANTIES OF MERCHANTABILITY OR FITNESS FOR PARTICULAR PURPOSE ARE EXPRESSLY EXCLUDED, EXCEPT AS EXPRESSLY SET FORTH HEREIN. COMPANY MAKES NO WARRANTIES WITH RESPECT TO THE PRODUCTS.

WARRANTY PERIOD: TWO YEARS (ONE YEAR FOR RADIANT QUANTITY), STARTING FROM CCS Inc. SHIPPING DATE.
 CCS Inc. WILL REPAIR OR REPLACE THE PRODUCT FREE OF CHARGE IF IT SHOULD FAIL TO FUNCTION OR IF THE RADIANT QUANTITY OF THE PRODUCT SHOULD DROP TO 50% OR LESS OF ITS INITIAL RADIANT QUANTITY WITHIN THE SPECIFIED WARRANTY PERIOD. IF EITHER OF THESE CONDITIONS OCCURS, PLEASE TAKE THE PRODUCT TO YOUR CCS SALES REPRESENTATIVE.

WARRANTY TERMS

- CCS Inc. WILL REPAIR OR REPLACE THE PRODUCT FREE OF CHARGE IF IT SHOULD FAIL TO FUNCTION UNDER USE ON OUR SPECIFIED CONDITION IN ACCORDANCE WITH THE INSTRUCTION GUIDE AND OTHER WRITTEN CAUTIONS DURING THE INDICATED WARRANTY PERIOD OF TWO YEARS.
- CCS Inc. WILL REPAIR OR REPLACE THE PRODUCT FREE OF CHARGE IF ITS RADIANT QUANTITY SHOULD DROP TO 50% OR LESS OF ITS INITIAL RADIANT QUANTITY UNDER USE ON OUR SPECIFIED CONDITION IN ACCORDANCE WITH THE INSTRUCTION GUIDE AND OTHER WRITTEN CAUTIONS DURING THE INDICATED WARRANTY PERIOD OF ONE YEAR.
- CCS Inc. WILL CHARGE A REPAIR FEE UNDER THE FOLLOWING CONDITIONS:
 - IF THE PRODUCT HAS BEEN SUBJECT TO MISUSE, UNAUTHORIZED REPAIRS, OR MODIFICATION FROM ITS ORIGINAL DESIGN.
 - IF THE PRODUCT HAS BEEN DAMAGED FROM IMPACTS DUE TO INAPPROPRIATE HANDLING.
 - IF DAMAGE TO THE PRODUCT RESULTS FROM EXTERNAL CAUSES INCLUDING ACCIDENTS, FIRE, POLLUTION, RIOTS, COMMUNICATION FAILURES, EARTHQUAKES, THUNDERSTORMS, WIND AND FLOOD DAMAGE, OR ANY OTHER ACT OF PROVIDENCE, OR FROM ANY EXTRAORDINARY CONDITIONS SUCH AS ELECTRICAL SURGES, WATER LEAKAGE, CONDENSATION, OR THE USE OF CHEMICALS.
 - IF THE DAMAGE RESULTS FROM CONNECTION TO ANY POWER SUPPLY OR TO ANY EQUIPMENT WHICH CCS Inc. DOES NOT MANUFACTURE OR DOES NOT SPECIFY FOR USE.
- CCS ASSUMES NO LIABILITY FOR ANY PURCHASER'S SECONDARY DAMAGE (DAMAGE OF EQUIPMENT, LOSS OF OPPORTUNITIES, LOSS OF PROFITS, ETC.) OR ANY OTHER DAMAGE RESULTING FROM A FAILURE OF OUR PRODUCT.

THIS WARRANTY INFORMATION PROVIDES THE SCOPE OF CCS'S PRODUCT WARRANTY WITHIN THE SPECIFIED PERIOD, AND DOES NOT INDICATE OR IMPLY ANY FURTHER GUARANTEE BEYOND THE WARRANTY TERMS.

CONTACT CCS FOR INQUIRIES OR INFORMATION ON REPAIRS TO THE PRODUCT AFTER THE EXPIRATION OF THE WARRANTY.

NOTE: THE RADIANT QUANTITY REFERS TO THE WATTAGE OF PHYSICAL ENERGY RADIATED FROM A LED. IT REFERS TO THE RADIATION LUMINOUSITY OF THE LED MEASURED UNDER CONDITIONS SPECIFIED BY CCS OR THE RADIATION ILLUMINATION OF THE LED UNDER SPECIFIED IRRADIATION CONDITIONS. CCS SPECIFIES THE RADIANT QUANTITY FOR EACH LED LIGHT BECAUSE THE MEASUREMENT AND IRRADIATION CONDITIONS VARY FROM THE FORM, THE APPLICATION AND THE IRRADIATION WAVELENGTH.

Please contact CCS for product information, and further information.

The Instruction Guide is available from CCS's website as well.

<http://www.ccs-grp.com>

CCS CCS Inc.

Headquarters
 Shimodachiuri-agaru, Karasuma-dori, Kamigyo-ku, Kyoto 602-8011 Japan
 Phone : +81-75-415-8284 Fax : +81-75-415-8278
 E-mail : intlsales@ccs-inc.co.jp

-8-