

Good Thinking, Good Future

2D Laser Displacement Sensor

LS Series

**FASTUS**

\* FASTUS is a product brand of Optex FA.

Linearity

$\pm 0.1\%$  of F.S.

Sampling period

$0.5\text{ ms}$  (max. speed)

Superbly affordable  
2D measurement



**A Revolution in Profile Measurement**

**OPTEX FA CO., LTD.**

# Line beam provides high-speed, high-precision measurement of height and width

Now you can perform whole-lot profile measurement on a range of production lines to ensure quality control of parts and materials. Offering superb high-speed performance and value for money, the FASTUS LS series handles high-precision 2D measurement applications that are not possible with spot-beam laser displacement sensors. The LS series is a new-generation profile measurement sensor that opens up a new category in the field of component measurement.

Repeatability	Resolution
Height (Z axis) <b>2 <math>\mu\text{m}</math></b>	Width (X axis) <b>25 <math>\mu\text{m}</math></b>
Linearity	Sampling period
<b><math>\pm 0.1\%</math> of F.S.</b>	Max. speed <b>0.5 ms</b>
	Total sampling period <b>5 ms</b>

## Proprietary system delivers high-speed, compact size, and low price

Employing a mathematical operation known as a projection transformation, which converts a captured image into distance, allows both height and width to be measured with a high degree of precision. Moreover, the use of a proprietary method in which the projection transformation is performed after triangulation—unlike competitors' systems, which performs the projection transformation on every pixel—makes it possible to significantly compress throughput and achieve high-speed measurement. The processing unit has also been kept small, to produce a compact, low-cost product.

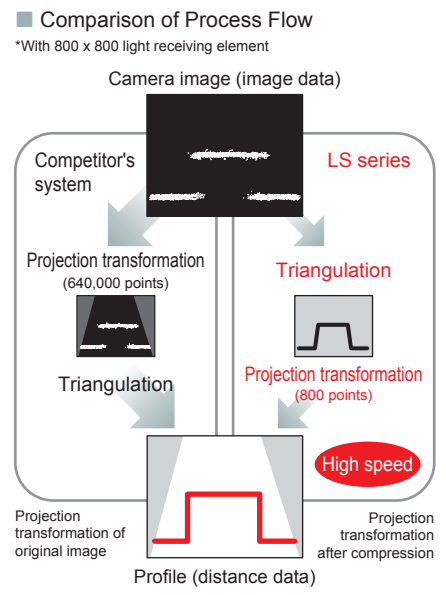

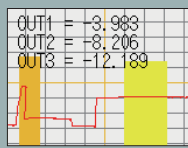
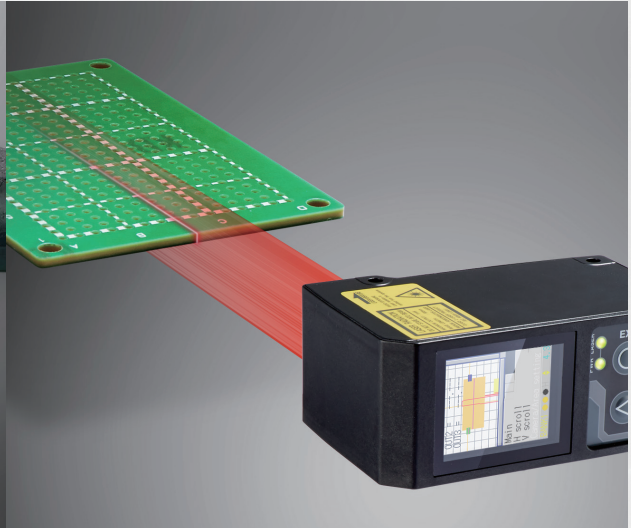
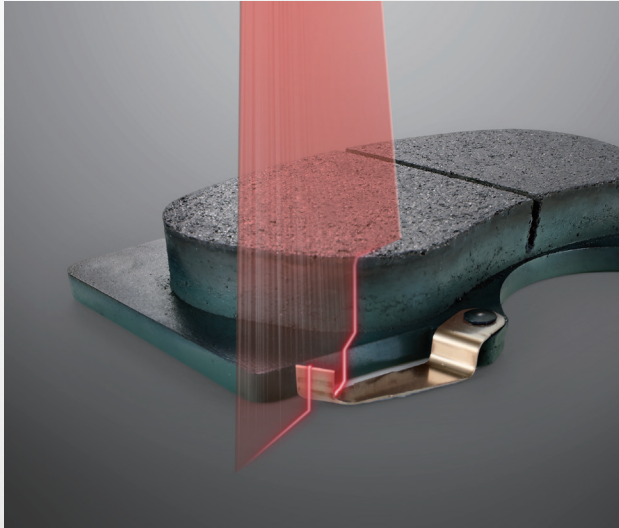

### Measurement of brake pad component height

Measures the position (height) of the end of the pad wear indicator (PWI), a metal part that indicates brake wear, relative to the brake surface.

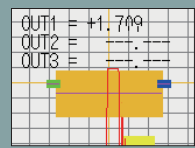

### Detection of double feeding of boards

Compared to previous systems in which a displacement sensor was installed above and below the boards to measure thickness, a single LS series unit can measure from the side, providing easy installation and line design.

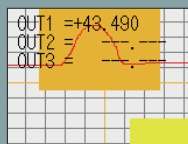
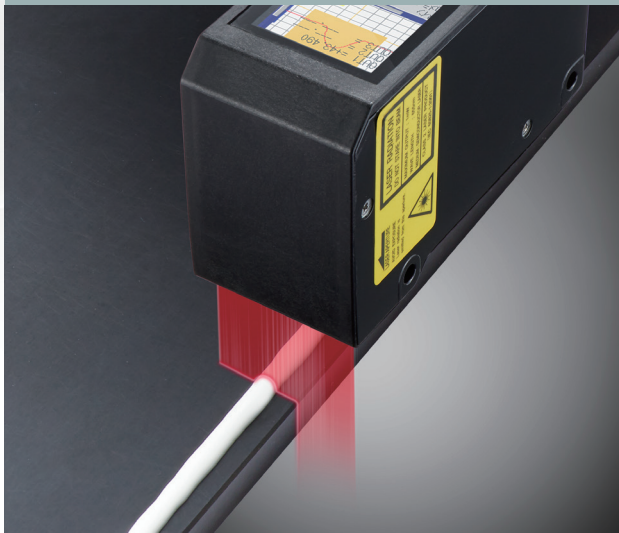

### Inspection of application position/amount of sealant

By measuring sealant width and height directly after application, feedback regarding the appropriate amount and position can be provided immediately.

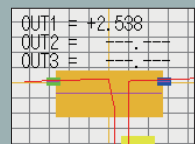

### Inspection of gap/level difference between automobile doors

Provides quick, non-contact measurement of gap and level differences between door and chassis to check precision of automobile door installation.

## Easy Setup

The LS series can be configured in four easy steps: imaging, profile, area measurement and calculation, and result judgment and output.

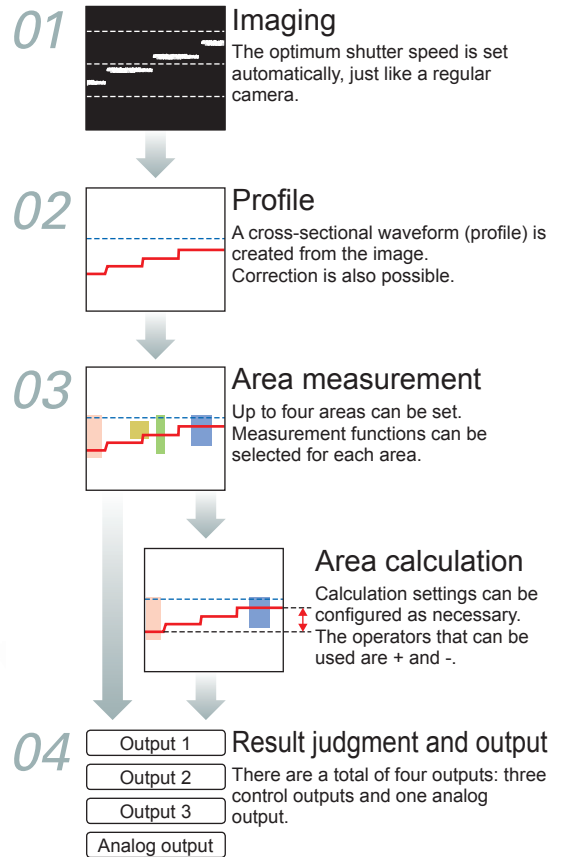

## Diverse Range of Measurement Functions

### Height

Allows measurement of average, peak, and bottom heights. The sensor outputs the average, maximum, and minimum values for the profile within the area.

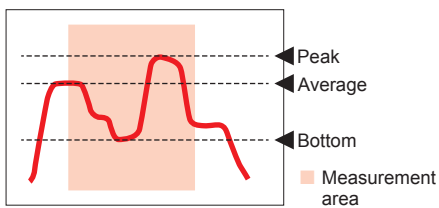

### Position

Allows measurement of peak, bottom, and edge positions.

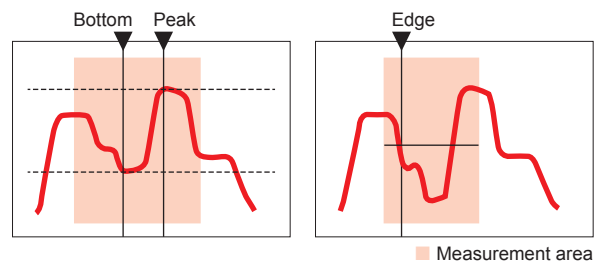

### Width

Allows measurement of width of gaps and differences in level. The sensor detects the width of the profile at the center line of the area in the height direction.

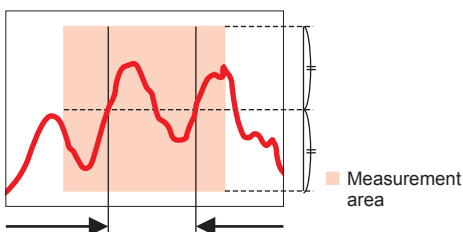

### Edge count

Counts the number of times the profile crosses the center line of the area in the height direction. This function can be used for applications such as counting the number of pins.

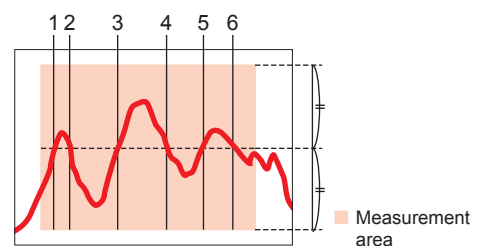

# Functions for Stable, High-precision Measurement

## Auto function

Simply set the workpiece and click "Auto Adjust" to automatically select the optimum shutter speed to suit the amount of light received from the workpiece.

Auto Adjust



## Profile correction function

The LS series is equipped with a profile correction function that corrects the positional displacement of the workpiece relative to a registered master image in terms of height, position, and tilt. Profile correction is effective on production lines where workpieces do not remain still.

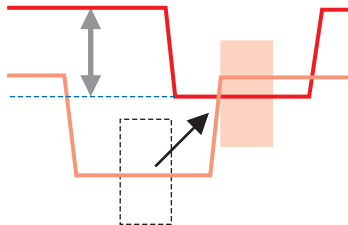

## Four camera modes

The LS series incorporates four camera modes for stable imaging: a standard, high resolution mode; high speed mode, which captures images at four times the standard speed; high dynamic range (HDR) mode, which increases the range of brightness; and noise reduction (NR) mode.



## HDR mode (High Dynamic Range)



HDR mode creates a composite image from two images taken with different shutter times. This function is useful for workpieces with areas of high contrast such as mirrored metal surfaces.

## NR mode (Noise Reduction)

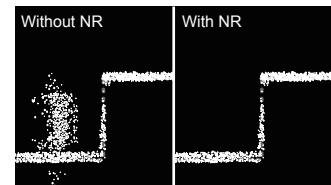

NR mode creates a composite image by amplifying an image of the bright areas and combining it with an image of the dark areas. This feature reduces noise such as ambient light.

## Tilt (°)

Creates a straight line approximating the profile, and then measures the tilt of this line. (Unit: °) This function measures and calculates the angle of both sides of gaps and protrusions.

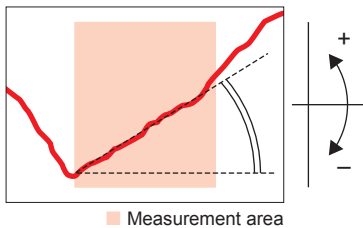

## Size (mm<sup>2</sup>)

Calculates the area between the specified side of the measurement area and the profile. Selecting "↑" measures the cross-sectional area of protrusions, while selecting "↓" measures the cross-sectional area of concave sections.

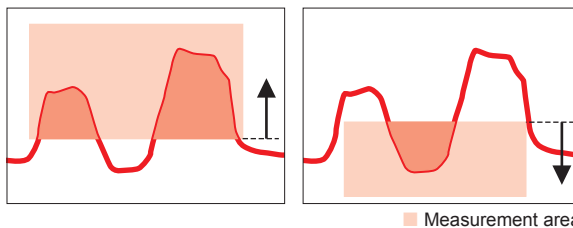

## Length

Measures the length of the profile. The value is the same even if the workpiece is misaligned, so this function can be used without position correction.

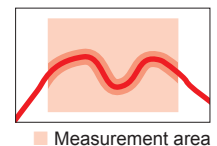

## Diameter

Measures the diameter of the approximate curve determined from the measured values. This function can be used to calculate the diameter of cylinders, protrusions, and gaps.

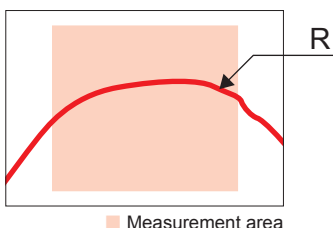

## Area calculation function provides a wider variety of measurement capabilities

**Example of level difference measurement**  
By measuring the height of the upper and lower surfaces of a step in two measurement areas and subtracting one from the other, it is possible to measure the difference in level. This allows you to ignore small areas of unevenness and variation, and enables more stable measurement compared to a displacement sensor.

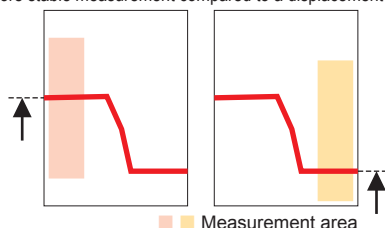

**Example of angle measurement**  
By measuring both angles of a feature in two measurement areas and subtracting one from the other, it is possible to measure the angle. This lets you accurately measure the outer angle of gaps and protrusions.

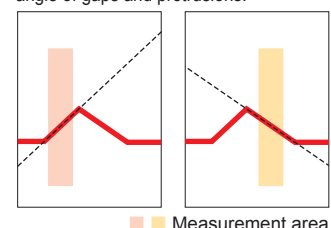

# Easily Configurable PC Software

## LS-Navigator (included as standard)

As standard, the LS series comes with software that lets you easily configure settings from a PC.

- Easy configuration of mask and measurement area settings
- All settings can be configured via RS-485 communication
- Profiles can also be output with high precision
- No need for expensive purpose-built displays

\* Requires separate PC connection cable (optional).  
 \* Window appearance and layout is subject to change.

**CD-ROM included**  
 Software can also be downloaded from website.

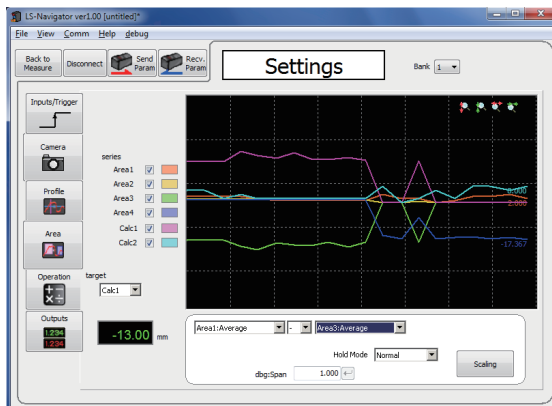

### Calculation settings

You can set up two calculation formulas by choosing "Calc1" and "Calc2".

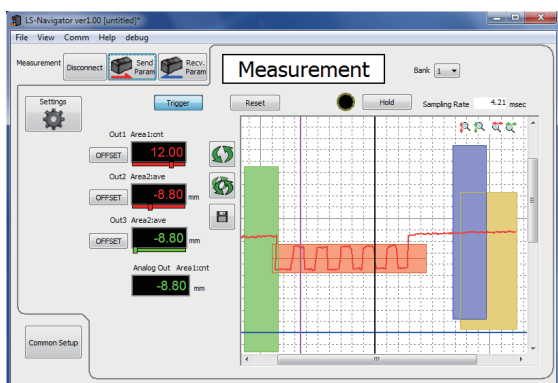

### Main screen

The main screen lets you check measurement results and profiles. You can also check hold and trigger operation from this screen.

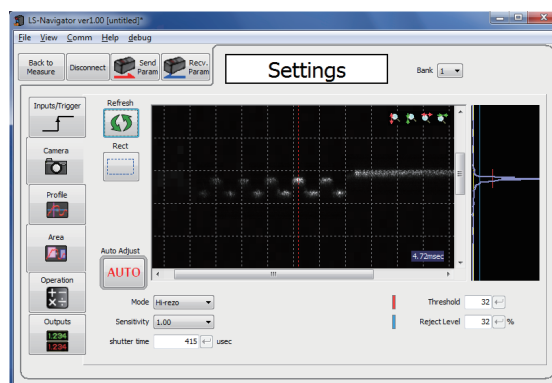

### Measurement screen

Settings screens are displayed as categories in the tabs on the left of the screen. Settings can be configured by selecting these tabs in order from top to bottom.

# Options (Cables)

These cables are not included as standard. Purchase separately as needed.



### Main cable

Cable for power supply, I/O, and analog output.

- 2 m STL-0H12-G02M
- 5 m STL-0H12-G05M
- 10 m STL-0H12-G10M

Specifications: ø6 12 pins x 0.2 mm<sup>2</sup>



### PC connection cable (USB)

Connects sensor to PC when using PC software.  
 RS-485-to-USB converter cable.

- 1.8 m DSL-DH06-G1M8



### RS-485 communication cable (discrete wire)

Discrete wire cable for RS-485 communication.

- 2 m DOL-SH06-G02M
- 5 m DOL-SH06-G05M
- 10 m DOL-SH06-G10M

# Measurement Range

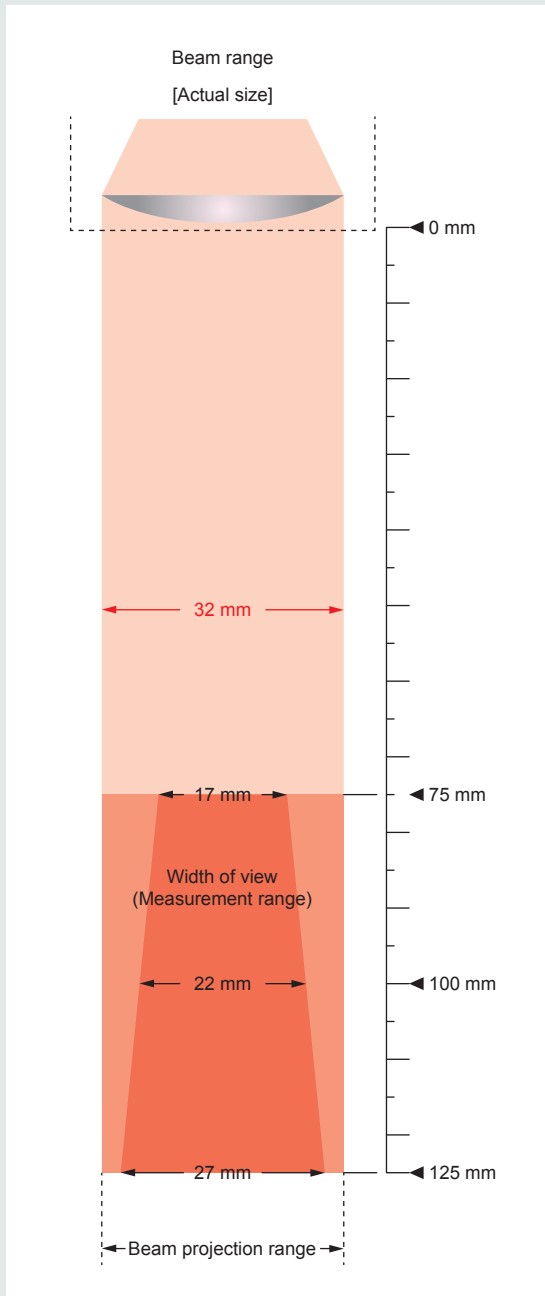

# Dimensions (mm)

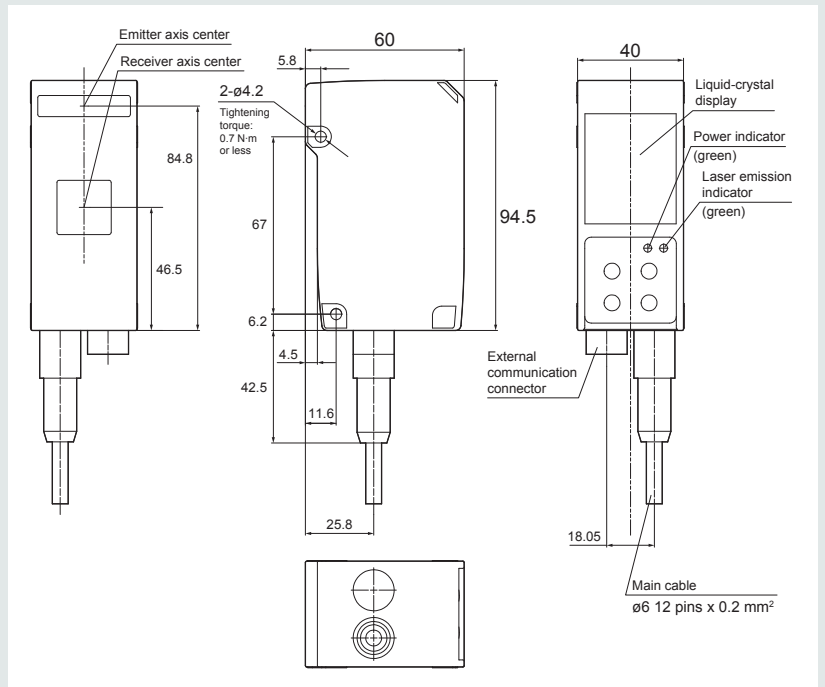

# I/O Circuit Diagram

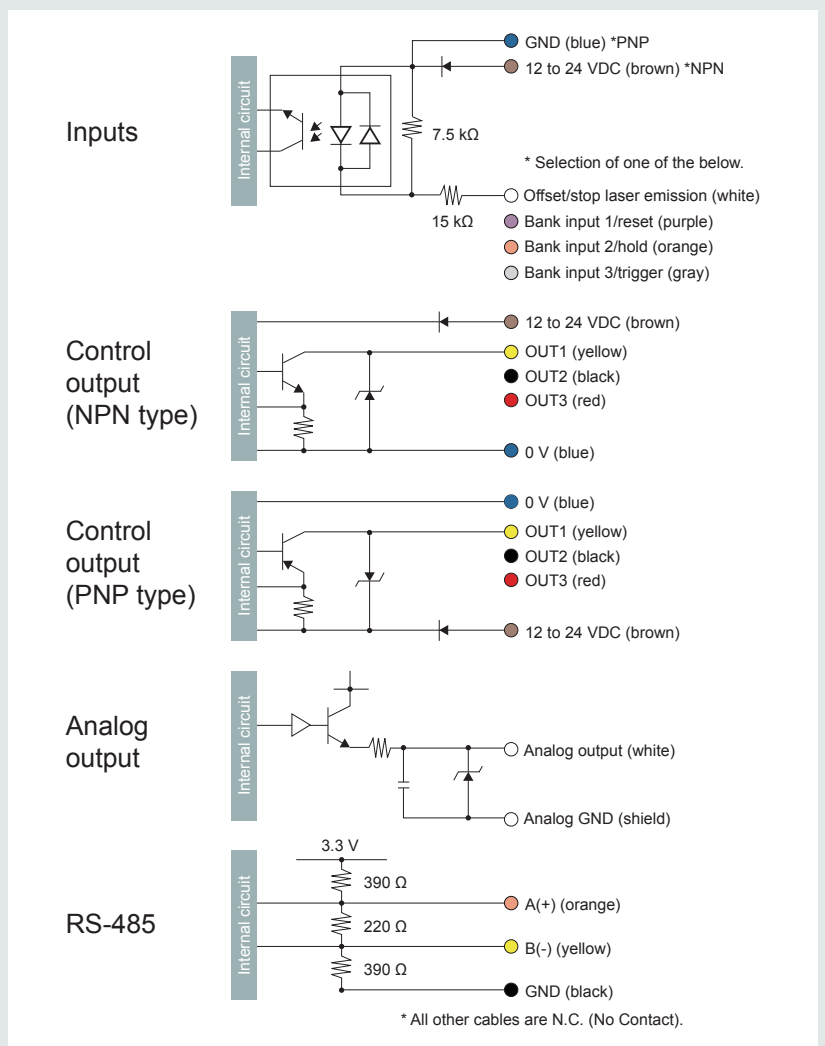

# Z Axis Material Linearity (Typical Value)

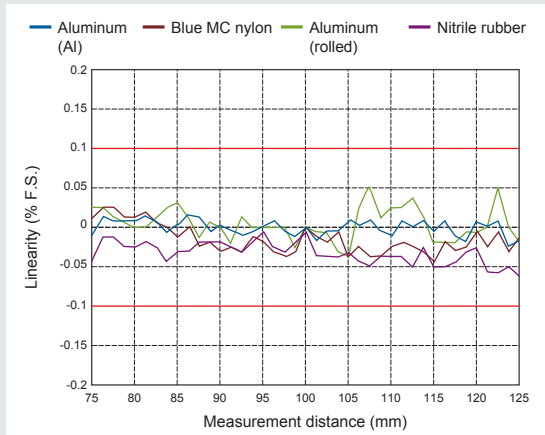

## ■ Specifications

Model		LS-100CN
Measurement range		100 ± 25 mm
Width of view (at measuring distance)		17 mm (at 75 mm) - 27 mm (at 125 mm)
Light source		Red laser, wavelength: 655 nm, max. output: 1 mW
Laser class	IEC/JIS	Class 2
	FDA	CLASS II
Spot size*1		0.3 × 32 mm
Linearity	Z axis	±50 μm (±0.1% of F.S.)
Repeatability*2	Z axis	2 μm
Resolution*3	X axis	25 μm
Sampling period		Typical value: 5 ms (when measuring the whole view in "Hi-res" mode), max. speed: 0.5 ms
Display		Dot matrix display
Indicators		Power indicator (green), laser emission indicator (green)
External input		Selectable from bank, trigger, hold, reset, laser emission stop, and offset
Control output		3 NPN open collector outputs, max. 100 mA/30 VDC (max. residual voltage: 1.8 V)
Analog output		4 to 20 mA, out of measurement range: 24 mA (max. load impedance: 300 Ω)
Communication I/F		RS-485 half duplex (9.6 kbps to 4.0 Mbps)
Temperature drift (typical example)		0.05% of F.S./°C
Power supply voltage		12 to 24 VDC (+10%, -5%, including ripple)
Current consumption*4		Max. 180 mA
Protection category		IP67
Operating temperature/humidity		-10 to +40°C/35 to 85%RH (no condensation or freezing)
Storage temperature/humidity		-20 to +60°C/35 to 85%RH (no condensation or freezing)
Operating illuminance		Sunlight: 10000 lx or less, high-frequency lamp: 3000 lx or less
Vibration resistance		10 to 55 Hz; double amplitude 1.5 mm; 2 hours in each of the X, Y, and Z directions
Shock resistance		Approximately 50 G (500 m/s <sup>2</sup> ), 3 times in each of the X, Y, and Z directions
Material		Housing: die-cast zinc and PC, laser emitter and receiver covers: glass
Weight		Approximately 300 g

● PNP output model is LS-100CP.

\*1 Defined with center strength  $1/e^2$  (13.5%) at the center of measurement range. The sensor may be affected when leak light other than that of the specified spot size is present and when there is a highly reflective object close to the detection area.

\*2 Average height measurement of a white workpiece with a center width of 5 mm, smoothing performed 8 times, moving average performed 32 times (with the default settings)

\*3 With a measurement distance of 75 mm

\*4 Power supply voltage: 24 VDC not including the control output load current and including the analog output

## ■ Warnings



### Warnings

Never look directly into a laser beam or point a laser beam at another person's eyes. Doing so may cause eye damage and may be harmful to health.

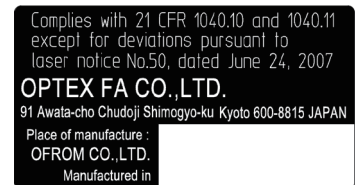
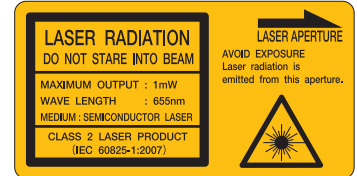
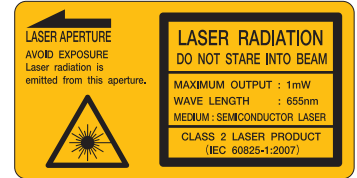

### Attention: Not to be Used for Personnel Protection.

Never use these products as sensing devices for personnel protection. Doing so could lead to serious injury or death. These sensors do not include the self-checking redundant circuitry necessary to allow their use in personnel safety applications. A sensor failure or malfunction can cause either an energized or de-energized sensor output condition. Please consult our distributors about safety products which meet OSHA, ANSI and IEC standards for personnel protection.

- Specifications are subject to change without prior notice.
- Specifications and technical information not mentioned here are written in Instruction Manual. Or visit our website for details.
- All the warnings and cautions to know prior to use are given in Instruction Manual.



**OPTEX FA CO., LTD.**

600-8815 Kyoto, Shimogyo, Chudoji Awata 91, Japan  
TEL. +81-(0)75-325-1314 FAX. +81-(0)75-325-2921  
<http://www.optex-fa.com>