

Dimensional Drawing

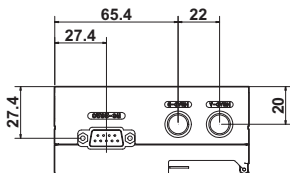

Option: Extension cable to connect the sensor head

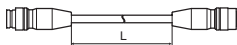

Length(L)	Cable type
2m	CD4CN-S-ROBOT
5m	CD4CN-5S-ROBOT

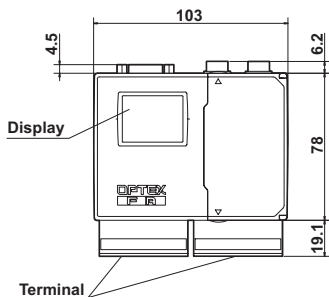

Unit: mm

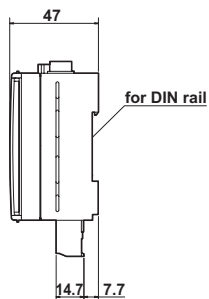

Package Descriptions

- Amplifier Main Unit
- Terminal Board x 2 pcs.
- Instruction Manual (Amplifier)
- Instruction Manual (Communication Version)

P-P (Peak to Peak)

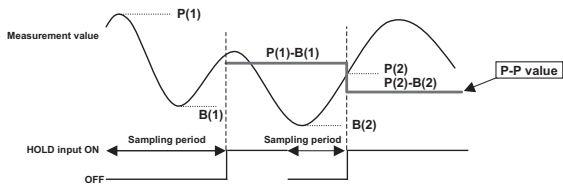

Auto peak

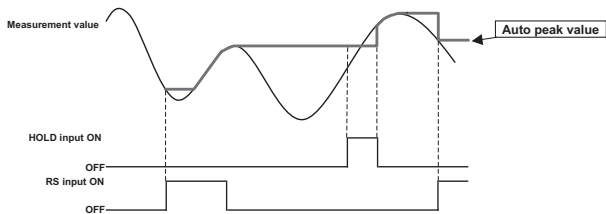

Auto bottom

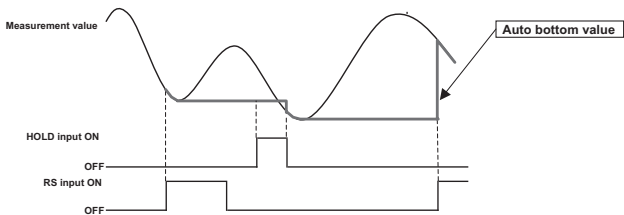

Hold Function Timing Diagram

Sample holding

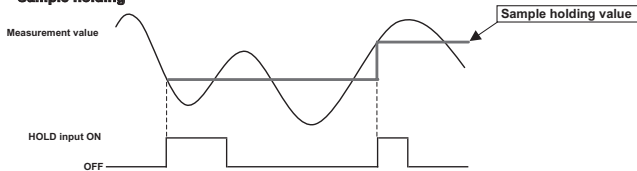

Peak holding

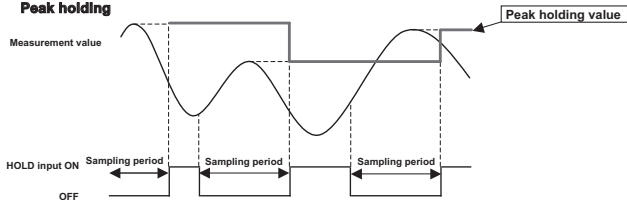

Bottom holding

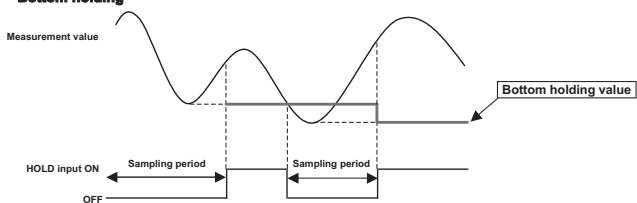

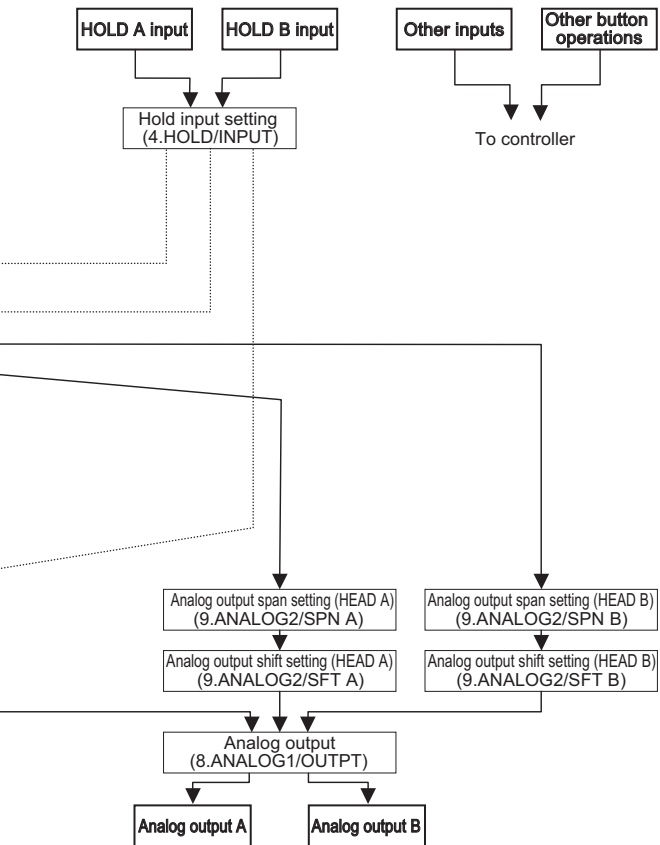

APPENDIX

Function Block Diagram

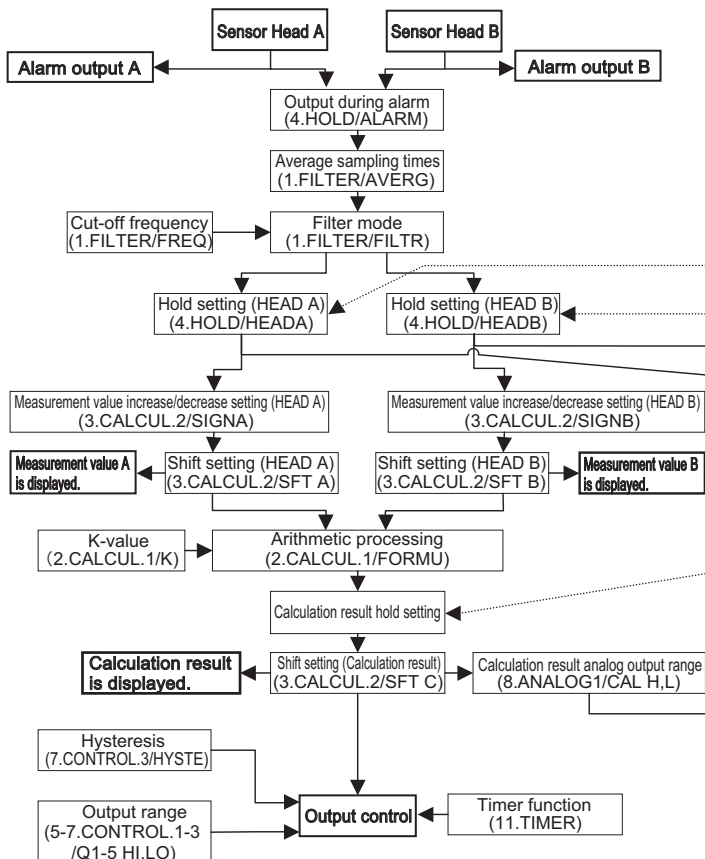

TERMINAL BOARD WIRING

1. Peel the cable coating to expose the cable core by 8 to 9 mm.

When using shield cable, twist so that the core diameter is less than $\text{Ø}1.2$ mm.

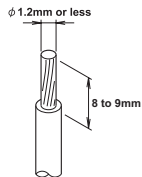

Peel the cable coating.

2. Press down the lever of the terminal until it is locked using a flathead screwdriver. Then insert the cable core until it is securely seated.

Insert the cable.

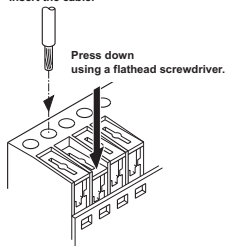

3. Press up the lever by finger until it is secured (sounds click).

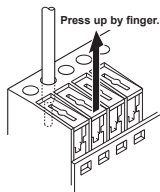





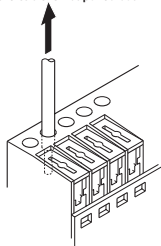

4. Pull the cable softly to ensure that the lever is locked and the cable is not pulled out.

Ensure that the cable core does not come out.

Ensure the cable is not pulled out.



Functions and Settings(3/3)

Function (Press   to select.)	Setting Item (Press   to select.)	Content (Press   to change.)	Initial setting (Value in () is for CDA4-L bank)	Selectable for each bank
13 BANK (Memory bank function)	BANK (Bank selection)	Selects the bank number(0 to 7). The setting is automatically activated with Bank selection button or Bank input terminal. The bank called up at power on is: - The latest bank selected by the button when no bank input terminal is connected - The bank selected by the input terminal when one or more input terminal is connected.	0	-
14 RS232C (RS232C function)	BAUD (Baud rate setting)	Set in accordance with the baud rate of the device to be connected. [bps]	38400	
	DATA (Data length setting)	Set in accordance with the data length of the device to be connected. [bit]	8	
	PARITY (Parity check setting)	Set in accordance with the parity check setting of the device to be connected. NONE/EVEN/ODD (None / Even number / Odd number)	NONE	

*0

When using Average sampling time, set Filter mode "off."

When using Filter mode, set Average sampling time "off."

*1

When the OUTPT setting of ANALOG1 function (No.8) is "A""B" and the measurement value of Sensor Head A(or B) is output as analog signal, the analog output level (reference level) is 0 V (12 mA) with no displacement change of workpiece. When the OUTPT setting is [] [CAL] and the calculation result value is output, the reference level depends on the CAL H/L setting of ANALOG1 function.

*2

25 mm type: 24.0000 mm

30 mm type: 25.000 mm

85 mm type: 65.000 mm

350 mm type: 250.000 mm

*3

When the OUTPT setting of ANALOG1 function (No.8) is "A""B" and the measurement value of Sensor Head A(or B) is output as analog signal, the analog output level is -5 V (4 mA) with P-P value "0." When the OUTPT setting is [] [CAL] and the calculation result value is output, the output level depends on the CAL H/L setting

of ANALOG1 function.

*4

The output range is set independently for each of the five(5) output controls. Select the settings as follows to set sequential output such as H/H/GO/LO/IL output. When the outputs are Q1=HH, Q2=HI, Q3=GO, Q4=LO and Q5=LL, for example, set the values Q1 LO=Q2 HI, Q2 LO=Q3 HI, Q3 LO=Q4 HI, Q4 LO=Q5 HI. Then add the HYSTE setting value to the values of Q2 to Q5.

*5

When the sensitivity setting is AUTO, the output control automatically changes from MIN to MAX depending on the workpiece. Since two(2) sampling cycles are required to change one(1) step of sensitivity setting, total 2 ms (2 sampling cycles x 10 steps) is required to shift from MIN to MAX.

The unit may fail in detection while the sensitivity is being shifted.

When the sensitivity setting is fixed (set to other than AUTO), the sensitivity remains constant but may fail in detection due to poor

sensitivity level when the displacement of workpiece largely changes.

When the sensitivity setting is fixed.

<< For CDA4 >>

set the output control to be "the lowest detection sensitivity level

+4" (if the control setting is over 9, set to MAX).

<< For CDA4-L >>

set to the sensitivity exceeding the threshold in all detected works

on the light receiving waveform monitor screen.







Set the sensor head setting to MEASURE after setting.

Functions and Settings(2/3)

Function (Press to select.)	Setting Item (Press to select.)	Content (Press to change.)	Initial setting Value n is for CD4A+.	Selectable for each bank		
4 HOLD (Hold function)	INPUT (Hold input setting)	Selects whether or not the Hold function is activated to Sensor Heads A/B measurement values and calculation result values (Cannot activated to both types of values). [A]B : HOLD A input = HEAD A hold input HOLD B input = HEAD B hold input []CAL: HOLD B input = Calculation result hold input (HOLD A input is deactivated.)	A,B			
	ALARM (Output during alarm)	Selects the status of measurement value when the sensor head fails in proper measurement. HOLD : Holds and outputs the value that is measured just before the failure. Hold function turns off when the sensor head starts normal operation. CLAMP: Sets the measurement value and analog input to their maximum values.	CLAMP			
5 CONTROL 1,2,3 6 7 (Output control (judgment) function)	Q1 to 5 HI/ LO (Output range)	Selects the upper / lower limit for the five(5) output controls. (Output control function is used for calculation result values. When using only either of Sensor Head A or B, select FORMU setting to A or B. -<< For CD4A >> -9999.999 to +9999.999 [mm] (You can use the digit position button.)(*4) -<< For CD4A-L >> -9999.999 to +9999.999 [mm] (You can use the digit position button.)(*4)	Q1 HI -9.000 (-0.6000) Q1 LO -9.000 (-0.4000) Q2 HI -92.000 (-0.4000) Q2 LO -1.000 (-0.2000) Q3 HI +1.000 (-0.2000) Q3 LO -1.000 (-0.2000) Q4 HI -1.000 (-0.2000) Q4 LO -2.000 (-0.4000) Q5 HI -2.000 (-0.4000) Q5 LO -3.000 (-0.6000)			
		Adjusts the hysteresis for output control. -<< For CD4A >> 0 to +9999.999 [mm] (You can use the digit position button.) -<< For CD4A-L >> 0 to +999.9999 [mm] (You can use the digit position button.)	HYSTE (Hysteresis)	0.100 (0.0200)		
		Specifies the analog output range of calculation result values and outputs as analog output. CAL H: upper limit, CAL L: lower limit. -<< For CD4A >> -9999.999 to +9999.999 [mm] (You can use the digit position button.) -<< For CD4A-L >> -999.9999 to +999.9999 [mm] (You can use the digit position button.) (Select [] CAL) in the OUTPT setting, ANALOG B terminal is allotted to the analog output of calculation result. ANALOG B terminal is allotted to the analog output of calculation results.)	CAL HL (Calculation result analog output range)	CAL H +5.000 (+1.0000) CAL L -5.000 (-1.0000)		
		ANALOG1 (Analog output function 1)	Selects whether or not the analog output is applied to the measurement values and calculation result values of Sensor Heads A/B. (Simultaneous output is not available.)	OUTPT		

4	<p>HOLD (Hold function)</p>	<p>HOLD A(B) input and HOLD RST input allow the following types of measurement. (Set the INPUT setting to A,B in the same display)</p> <p>OFF : Normal mode. (When HOLD A(or B) input is set to ON in OFF mode, the sensor head A(or B) stops laser emission.</p> <p>PEAK : Holds and outputs the maximum value during measurement. The unit samples the value from the end of HOLD A(or B) input to the start of next input. The measurement value is output when HOLD A(or B) input is ON.</p> <p>BOTTOM : Holds and outputs the minimum value during measurement. The unit samples the value from the end of HOLD A(or B) input to the start of next input. The measurement value is output when HOLD A(or B) input is ON.</p> <p>P-P : Holds and outputs the maximum and minimum values during measurement. The unit samples the value from the end of HOLD A(or B) input to the start of next input. The measurement value is the sum of the measurement value and the minimum value in the measurement range of Sensor Head A(or B)(*2), you can obtain the P-P value by deducting the value using Shift setting (*3).</p> <p>AUTOPEAK : Holds and outputs the maximum value after HOLD RST input starts. The maximum value is fixed when HOLD A (or B) input is ON.</p> <p>AUTOBOTOM: Holds and outputs the minimum value after HOLD RST input starts. The minimum value is fixed when HOLD A (or B) input is ON.</p> <p>Using Hold B input or HDLD RST input to calculation result allows the following types of measurement. (To use this function, INPUT setting in you country should be change to [](CAL1))</p> <p>OFF : Normal setting</p> <p>SAMPLE PEAK : Holds and outputs the spot value of HOLD B input in real time. Holds and outputs the maximum value during measurement. The unit samples the value from the end of HOLD B input to the start of HOLD A input. The measurement value is output when HOLD B input is ON.</p> <p>BOTTOM : Holds and outputs the minimum value during measurement. The unit samples the value from the end of HOLD B input to the start of HOLD B input. The measurement value is output when HOLD B input is ON.</p> <p>P-P : Holds and outputs the maximum and minimum values during measurement. The unit samples the value from the end of HOLD B input to the start of HOLD B input to the start of HOLD B input. The measurement value is output when HOLD B input is ON.</p> <p>AUTOPEAK : Holds and outputs the maximum value after HOLD RST input starts. The maximum value is fixed when HOLD B input is received.</p> <p>AUTOBOTOM: Holds and outputs the minimum value after HOLD RST input starts. The minimum value is fixed when HOLD B input is received. The maximum value is fixed when HOLD B input is received.</p>	<p>OFF</p> <p>○</p>
	<p>HEAD A/B [Hold setting (HEAD A/B)]</p> <p>CALCU [Hold setting (Calculation result)]</p>	<p>OFF</p> <p>○</p>	

Functions and Settings(1/3)

Function (Press   to select.)	Setting Item (Press   to select.)	Content (Press   to change.)	Initial setting Value in () is for CD4A-L	Selectable for each bank
1	FILTER (Filter function)	<p>Selects the average number of the measurement value. Select the larger value setting to ignore sudden displacement changes, and select the smaller value setting to ensure a quick response.</p> <p>OFF 4/ 16/ 64/ 256/ 1024/ 4096</p> <p>OFF: Normal mode HIPASS : ignores slow changes to accurately detect joint parts etc. (*1) LOPASS : ignores rapid changes and detects slow changes only.</p>	256	○
	FILTR(*0) (Filter mode)	OFF : Normal mode	OFF	○
	FREQ (Cut-off frequency)	<p>Selects the cut-off frequency of filter. Left: HIPASS frequency, RIGHT: LOPASS frequency.</p> <p>650/2000, 350/800, 200/400, 100/200, 50/100, 25/50, 15/20, 10/10 (Hz)</p> <p>Selects the arithmetic processing formula. The result appears on RUN display.</p> <p>A, B, A+B, A-B, -A-B, K+A+B, K+A-B, K+A-B, K+A, K+B</p>	650/2000	○
2	FORMU (Arithmetic processing)	Selects K-value of the selected formula.	A	○
	CALCUL.1 (Calculation function 1)	<p><< For CD4A >> -9999.999 to +9999.999 [mm] (You can use the digit position button.) << For CD4A-L >> -999.9999 to +999.9999 [mm] (You can use the digit position button.)</p>	0.000 (0.0000)	○
3	SIGNA/B (Measurement value increase/decrease setting (HEAD A/B))	<p>Selects the relation between the distance to workpiece and the increase/decrease of measurement value. SIGNA: Sensor Head A, SIGNB: Sensor Head B.</p> <p>FAR SIDE+ : The measurement value increases as the distance to workpiece becomes longer (Normal setting).</p> <p>NEAR SIDE+: The measurement value increases as the distance to workpiece becomes shorter. This is the reverse setting of FAR SIDE+.</p>	FAR SIDE+	○
	SFT A/B (Shift setting (HEAD A/B))	<p>Adds/reduces a specified value to/from the measurement value (displayed value). The setting is automatically activated with Zero reset button A(or B) and Zero reset input A(or B).</p> <p><< For CD4A >> -9999.999 to +9999.999 [mm] (You can use the digit position button.) << For CD4A-L >> -999.99999 to +999.99999 [mm] (You can use the digit position button.)</p>	0.000 (0.0000)	○
	SFT C (Shift setting (Calculation result))	<p>Adds/reduces a specified value to/from the calculation value (displayed value). The setting is automatically activated by simultaneous pressing of Zero reset buttons A and B, or simultaneous Zero reset input from sensors A and B.</p> <p><< For CD4A >> -9999.999 to +9999.999 [mm] (You can use the digit position button.) << For CD4A-L >> -999.99999 to +999.99999 [mm] (You can use the digit position button.)</p>	0.000 (0.0000)	○

Light Receiving Waveform Monitor

You can monitor the light receiving waveform on the light receiving element.
<< CD4A-L only >>

Setting

Set the MODE of 10. HEAD to !IMAGE A (for Sensor Head A), or to !IMAGE B (for Sensor Head B), and set to the RUN mode using the SET/RUN button.

The screen changes to the normal RUN screen to display the light receiving waveform on the light receiving element.

Screen Description

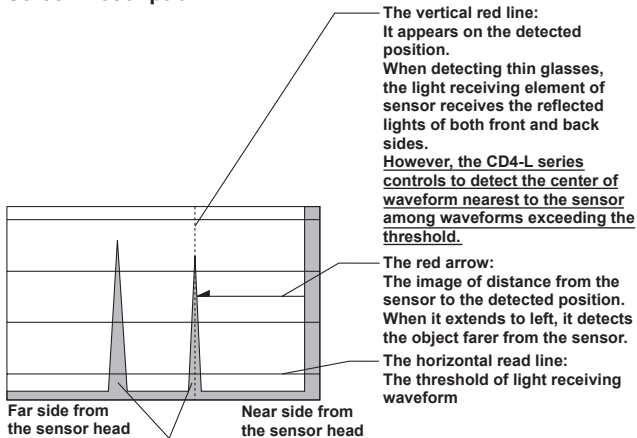

The blue waveform is the reflected light from the object.
The upper the line extends, the stronger the reflected light is.

Note

- While this screen is displayed, all output of CD4A-L stop updating. Be sure to set MODE of 10.HEAD to MEASURE after checking the waveform.
(Re-turning on the power automatically sets to the MEASURE mode.)
- Due to the speed of liquid crystal image process, the waveform to the moving object cannot be imaged accurately.
Therefore, check the waveform with the object stopped.

Setup Procedure

1. Press the display mode button (SET/RUN) to switch to Setup display.

```
A =  
B =  
CAL=  
JDG= 1--■--5  
BNK= 0  
LSR= A ON B OFF
```

2. Press the bank button (BANK) to select the bank number that you want to work with.

```
SET/RUN ↓ (BANK)
```

```
1. FILTER B 0 ←  
AVRG = 256  
FILTR = OFF  
FREQ =650/2000
```

3. Press the cursor buttons (RIGHT/LEFT) to select the function.
4. Press the cursor buttons (UP/DOWN) to select the setting item.
5. Press the cursor buttons (RIGHT/LEFT) to change the setting.



You can use the digit position button to easily set the values.

Press the cursor buttons (RIGHT/LEFT) to change the digit position.

Press the digit position button again to return to the normal selection mode.

6. Press the display mode button (SET/RUN) to switch to RUN display.

Select the function.

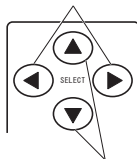

Select the setting item.



Select the setting.

SETTINGS

Displacement Sensor CD4 Functions. Refer to page 16, "Functions and Settings".

1. Filter function
- 2-3. Calculation function
4. Hold function
- 5-7. Output control (judgment) function
- 8-9. Analog output function
10. Sensor head sensitivity control function
(for CD4A-L, Sensor head function)
11. Timer function
12. Memory function
13. Memory bank function
14. RS232C function

Setup Display

Press the display mode button [SET/RUN] to select the Setup display, and press the cursor buttons to select the settings.

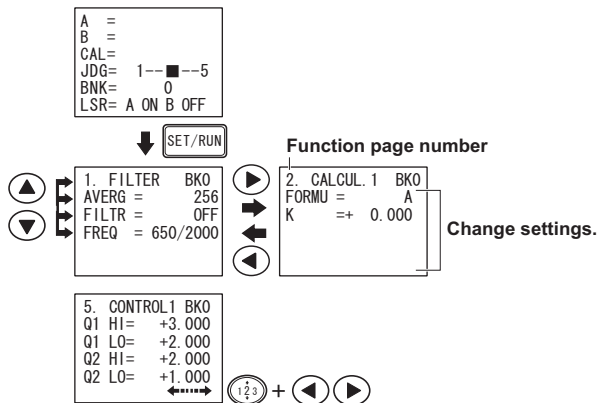

You can change the digit position of each value using the digit position button.

When either of Sensor Head A or B is 350 mm type, the calculation result value is displayed in units of $10\ \mu\text{m}$ (to two decimal places).

<< For CD4A-L >>

Dedicated for the sensor head type 25mm: Both the measurement value and the calculation result value are displayed in units of $0.1\ \mu\text{m}$ (to four decimal places).

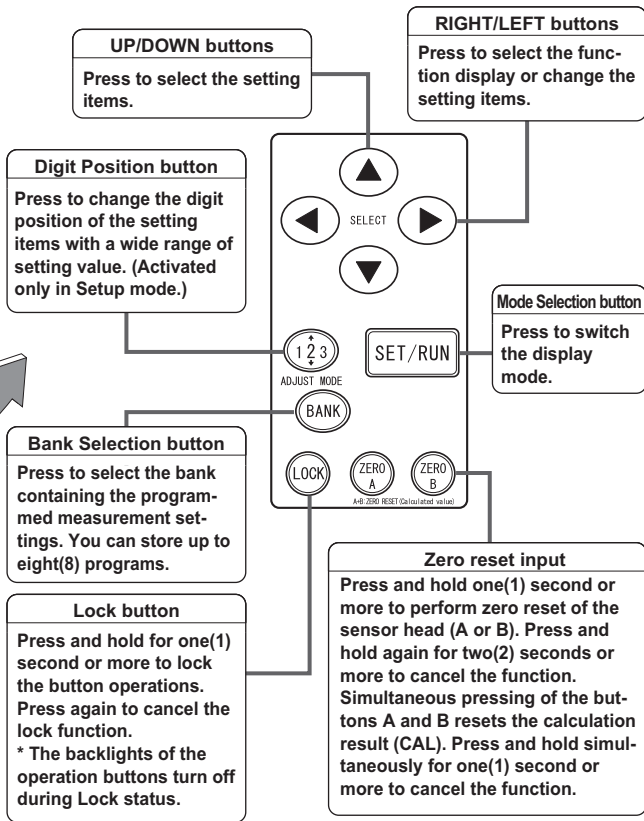

Digit number of measurement value

<< For CD4A >>

Sensor head type 30 mm or 85 mm: 1 μm (to three decimal places) display for both of measurement value and calculation result value.

Sensor head type 350 mm: 10 μm (to two decimal places) display for measurement value.

BASIC INFORMATION BEFORE USE

Parts Identifications of Amplifier

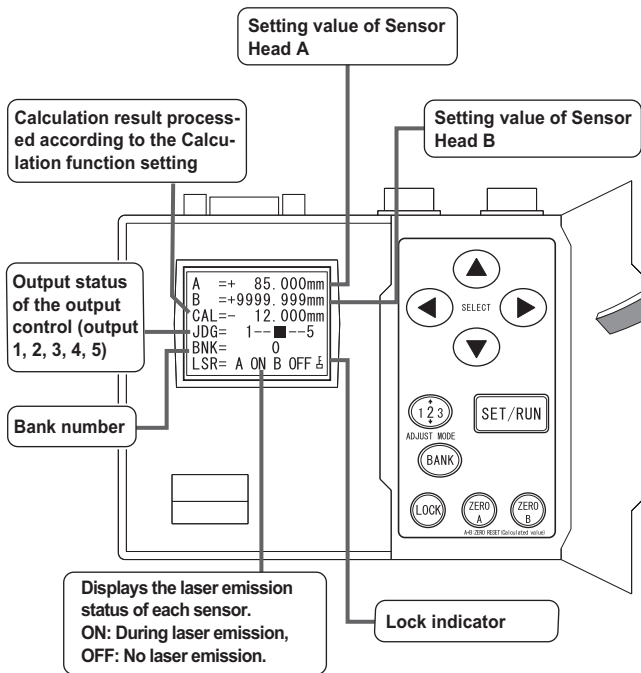

Color of measurement value

- Blue The spot value in real time.
- Black The value held by the hold function.
- Red The sensor head is incapable of measurement.

Input/Output Diagram

NPN model bank input
Hold input
Zero reset input

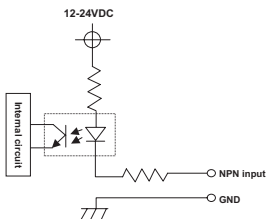

NPN model control output
Alarm output

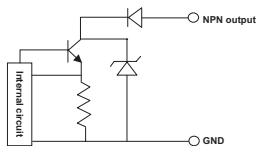

PNP model bank input
Hold input
Zero reset input

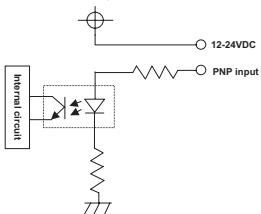

PNP model control output
Alarm output

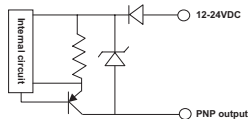

Analog output (A/E)

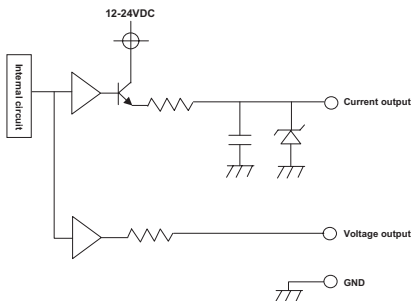

Specifications

Model		CD4A-N, CD4A-LN	CD4A-P, CD4A-LP
		NPN output type	PNP output type
Number of connected sensor heads		Max. 2 pcs	
Sampling frequency		100 μ s	
Supply voltage		12 to 24 V, DC \pm 10 %	
Power consumption		270 mA/24 V(When connected with 2 sensor heads. Including analog current output)	
Temperature drift		\pm 0.01% F.S./ $^{\circ}$ C	
Analog output	ANG(V)[A],[B]	Voltage output \pm 5 V/F.S. (Output impedance 100 Ω , resolution 1 mV)	
	ANG(mA)[A],[B]	Current output 4 to 20 mA/F.S. (Load impedance Max. 300 Ω , resolution 1.5 μ A)	
Alarm output	ALM A,	NPN open collector	PNP open collector
	ALM B	Max. 100 mA / DC 24 V (residual voltage Max. 1.8 V) Turns ON when the sensor head fails in measurement.	
Control output	JDGE 1 to 5	NPN open collector	PNP open collector
		Max. 100 mA / DC 24 V (residual voltage Max. 1.8 V) HI/LO setting for each line and Hysteresis setting are available.	
Bank input	BANK 0 to 2	ON when connected to GND	ON when connected to 12 to 24 V
Hold input	HOLD A, HOLD B, HOLD RST	8 banks selectable ON when connected to GND ON when connected to 12 to 24 V Laser off or measurement value holding (selectable in the menu)	
Zero reset input	ZERO A, ZERO B	ON when connected to GND ON when connected to 12 to 24 V Zero reset of Head A measurement value / Head B measurement value / Calculation value is available.	
Optional features		Average sampling times, Filter mode (Cut-off frequency), Calculation, Hold setting, Output during alarm, Output control (Hysteresis),Analog output, Sensor head sensitivity control, Timer function, Memory function, Memory bank function, Auto zero reset	
Display type		LCD display	
Protection category		IP20	
Operating temperature		-10 to +45 $^{\circ}$ C (Non-condensing) / For storage: -20 to +60 $^{\circ}$ C	
Operating humidity		35 to 85 % RH / For storage: 35 to 85 % RH	
Vibration resistance		10 to 55 Hz, Double amplitude 1.5mm, 2 h for XYZ axes	
Shock resistance		20 G (196m/s ²)	
Material		Chassis: Polycarbonate, Terminal board: Nylon 66	
Weight		240 g (including terminal board)	

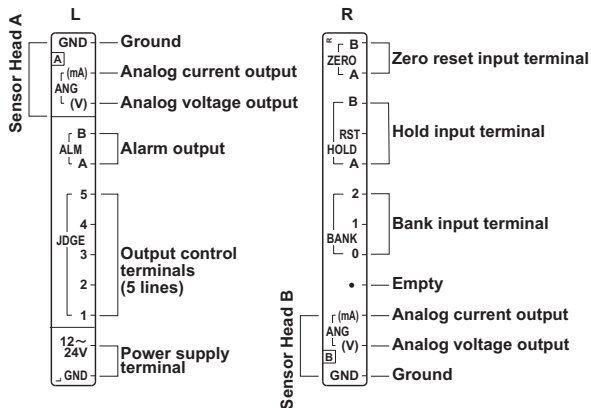

Zero reset input

Zero reset of single sensor (either A or B) is activated with input of 10 ms or more, and deactivated with 500 ms or more.

Zero reset of calculation result is activated with simultaneous input from sensors A and B, and deactivated with simultaneous input of 500 ms or more. (For "simultaneous" input, the time difference between sensor A and B inputs should be within 10 ms.)

Bank selection input

Bank No.	Bank 2 input	Bank 1 input	Bank 0 input
0	OFF	OFF	OFF
1	OFF	OFF	ON
2	OFF	ON	OFF
3	OFF	ON	ON
4	ON	OFF	OFF
5	ON	OFF	ON
6	ON	ON	OFF
7	ON	ON	ON

Combination of Amplifier and Sensor Head

Amplifier	Sensor Head
CD4A-N	CD4-30 CD4-350
CD4A-P	CD4-85
CD4A-LN CD4A-LP	CD4-L25

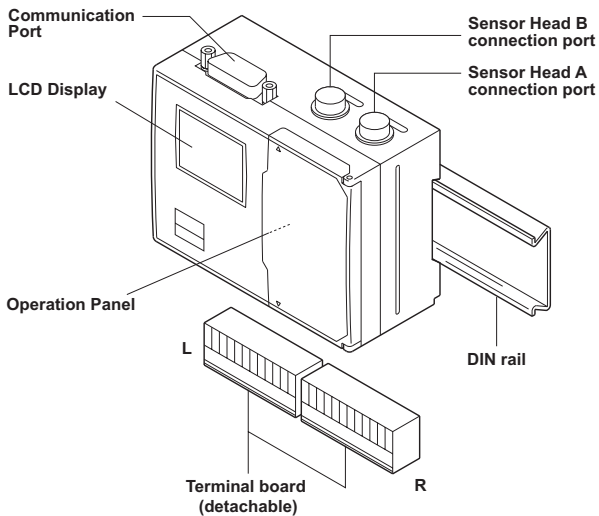

Cautions for Laser Product

The sensor-head light source of the displacement sensor CD4 series is Class 2(II) Red Laser Diode, and compliant with JIS C6802/IEC/FDA laser safety standard Class 2(II). (CD4-L25 is compliant with JIS C6802/IEC Class 1.) Do not stare into direct laser beam or reflected beam by mirror.

Model	CD4-L25	CD4-30	CD4-85	CD4-350
Wavelength	650nm			
Output	390 μ W	1mW		
Pulse width	100 μ s			



- When incorporating the unit into your product, provide an enduser with information that it is laser product and should be properly operated.

- Use the service voltage specified in the specifications.
- Do not touch the main unit and cable with wet hands. It may cause electric shock.
- Use only the special sensor head.
- Do not connect/disconnect the sensor head connector, terminal board or wiring when the power is on.

Precautions for Installation



- Installing the unit in the following conditions may result in fire, electric shock or product damage.
 - High humidity
 - High temperature due to a direct sunlight, etc.
 - Much dust
 - Poor ventilation
 - Static electricity
 - Corrosive gas or flammable gas
 - Exposure to water, oil, or chemicals
 - Direct exposure to vibration or impact
- Do not apply electricity during wiring. Ensure that the analog output does not contact with other wiring.



- Avoid parallel wiring and placing in the same piping with high-voltage cable or power transmission cable, since they may cause noise resulting in malfunction. Keep the power and signal cords in short length.
- Do not pull or apply impact forcibly since it may cause product damage.
- When using switching regulator for power supply, ensure grounding the frame ground terminal.
- Wait for approximately 5 minutes as warming-up time after turning the power on.

SAFETY PRECAUTIONS

Carefully read and understand the safety precautions before operation. They provide the important information to protect your health and property. Strictly follow this instruction manual, and do not apply any other installing/operating procedure which is not described in this manual.

Meanings of Safety Symbols



Indicates a possible hazard that may result in death or serious injury if the product is used without observing the stated instructions.



Indicates a possible hazard that may result in personal injury or property damage if the product is used without observing the stated instructions.

Mandatory Requirements



- Do not disassemble or modify the product since it is not designed to automatically stop the laser emission when open. Disassembling or modifying at customer's end may cause personal injury, fire or electric shock.
- If smoke or abnormal smell occurs, stop operation and turn power supply off. If the problem requires a repair, contact to the sales office or store where you purchased the product.
- This product cannot be used as a safety device to protect human body.

FOREWORD

Thank you for purchasing the Displacement Sensor CD4 Series. We hope you are fully satisfied with this product and enjoy its performance. To ensure your satisfaction, please follow the instructions below.

- Carefully read this instruction manual and keep it for future reference.
- If you have any question about the instructions here or a request for replacing the lost instruction manual, contact the sales office or store where you purchased this product.
- The contents in this instruction manual are protected by copyright and all rights are reserved by OPTEX FA CO., LTD. The descriptions and information included in this manual shall not be copied nor reproduced to any other form.



This product cannot be used as a safety device to protect human body.



This products may be listed as articles to be regulated for export such as strategic materials by the Foreign Exchange and Foreign Trade Control Act. Therefore, if you intend to export these, be sure to follow the necessary procedures, such as application for an export permit from the Government.

Warranty

Whereas all of our products are tested in accordance with the strict internal standard, a faulty unit may unexpectedly be distributed. If this is the case with your product, identify its status and contact the sales office or store where you purchased it.

- The warranty period shall be one(1) year after its delivery to the customer.
- If the failure results from a manufacturer's fault, the manufacturer will replace the product (by sending a substitute) without charge except the following cases:
 1. Failure due to any abuse or misuse
 2. Failure due to a cause other than the product
 3. Failure due to unapproved modification or repair
 4. Failure due to acts of God

This warranty is limited to the delivered product only.

This warranty shall not cover the secondary damage caused by the faulty product.



Amplifier Instruction Manual

Displacement Sensor CD4 Series

CD4A-N/CD4A-LN/CD4A-P/CD4A-LP

Laser Type

(Please refer to CD4 Sensor Head CD4-L25, CD4-30, CD4-85 and CD4-350 Instruction Manual for the sensor head)

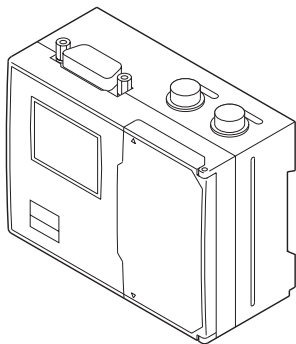

FOREWORD 2

SAFETY PRECAUTIONS 3

Meanings of Safety Symbols ...	3
Mandatory Requirements	3
Precautions for Installation	4
Cautions for Laser Product	5
Specifications	8
Input/Output Diagram	9

BASIC INFORMATION

BEFORE USE 10

Parts Identifications of Amplifier	10
---	----

SETTINGS 13

Setup Display	13
Setup Procedure	14
Light Receiving Waveform Monitor	15
Functions and Settings	16

TERMINAL BOARD WIRING 21

APPENDIX 22

Function Block Diagram	22
Hold Function Timing Diagram.....	24
Dimensional Drawing	26
Package Descriptions	26

Manufactured and sold by :



OPTeX FA CO., LTD.

607-8085 Kyoto, Yamashina, Takehanadonomaecho 46-1, JAPAN
Tel : +81-(0)75-594-8123 Fax : +81-(0)75-594-8124

Website : <http://www.optex-fa.com>