

**COGNEX®**

---

# Checker® 4G™









Quick Start Guide

**CHECKER**

# Table of Contents

Table of Contents . . . . .	3
Checker 4G Accessories . . . . .	4
Checker 4G Overview . . . . .	5
Dimensions, Connectors, Indicators . . . . .	6
Getting Started . . . . .	7
Connecting to Checker . . . . .	8
Checker Network Configuration . . . . .	9
Checker User Interface . . . . .	10
Part Trigger . . . . .	12
Part Finding Sensor . . . . .	13
Presence Sensors . . . . .	14
Measurement Sensors . . . . .	15
Filmstrip Control . . . . .	16
Filmstrip Mode Selector . . . . .	17
Power and I/O Connector . . . . .	18
Power, Trigger, and Output Wiring . . . . .	19
Wiring an External Retrain Line . . . . .	20
Wiring a Job Change Signal . . . . .	21
Wiring an Encoder . . . . .	22
Checker I/O Circuits . . . . .	23
Mounting Checker . . . . .	24
Working Distance and Field of View . . . . .	26
Adjusting Focus . . . . .	27
Changing Lenses . . . . .	28
Installing and Removing Filters and Lights . . . . .	29
Specifications . . . . .	30
Precautions . . . . .	31

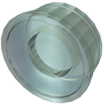
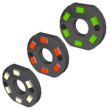
## Checker 4G Accessories

	<p><b>Flying Lead Cable (C3G-CBL-001)</b></p>		<p><b>M12 Ethernet Cable (CCB-84901-1003-05)</b></p>
	<p><b>I/O Extender (CKR-200-CBL-EXT)</b> Power and I/O extension cable (5m).</p>		<p><b>Mounting Bracket (CKR-200-BKT)</b> Provides flexible mounting options for Checker.</p>
	<p><b>Right-Angle Cable (CKR-200-CBL-RT-003)</b> Power and I/O extension cable with low-profile right-angle connector (1m).</p>		<p><b>Lens Kit (CKR-200-LENSKIT)</b> Set of 3.6mm, 8mm, 16mm, and 25mm lenses provide more field of view and working distance options.</p>
	<p><b>Bandpass Filters (CKR-BPnnn)</b> Bandpass filters for both visible and IR wavelengths. <i>nnn</i> indicates band center (470, 525, 590, 635, and 850 nm available).</p>		<p><b>Polarizing Window (CKR-WINDOW-POL)</b> Replacement lens cover with optical polarizer pre-installed.</p>
	<p><b>Illumination Modules (CKR-xxxL-00)</b> Red or green lighting. (CKR-RDRL-00 and CKR-GNRL-00)</p>		<p><b>Repair Kit (CKR-4G-REPAIRKIT)</b> Replacement 5.8mm lens, locking ring, wrench, M12 IP67 plug, lens cover, O-ring, and mounting screws.</p>

## Checker 4G Overview

The Checker 4G sensor provides direct discrete I/O and power connections as well as Ethernet connections to PCs and networked PLCs.

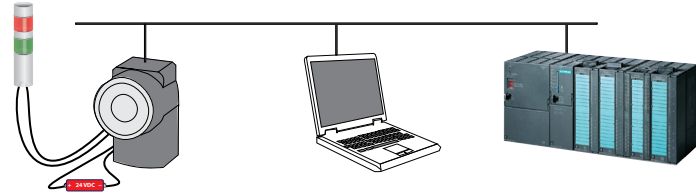

Checker 4G is available in both a high-speed 6000 inspections per minute version (Checker 4G1) and a high-resolution 752 x 480 pixel version (Checker 4G7).

## Dimensions, Connectors, Indicators

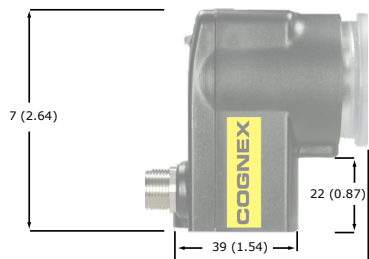

1	Mounting holes (M4 x 4 mm)
2	Focus lock (M3, use 2.5 mm hex key)
3	Lens cover/focus ring
4	Ethernet Traffic Indicator: Green: Link present Yellow: Traffic send/receive
5	Status LED: Blinking Green: Setup mode Green: Run mode part passed Red: Run mode part failed Red/Green Blink: Internal error
6	Ethernet connector with M12 plug
7	Power and I/O connector with M12 plug

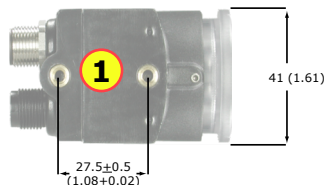

## Getting Started

Step	Using a PC
1. Review PC system requirements	<ul style="list-style-type: none"> <li>Microsoft® Windows XP™ (32 bit), Windows Vista™ (32 bit), or Windows 7™ (32 or 64 bit)</li> <li>128 MB RAM</li> <li>1024 x 768 (96 DPI) or 1280 x 1024 (120 DPI) display</li> <li>Ethernet port</li> </ul>
2. Install Checker PC software	<ol style="list-style-type: none"> <li>Insert CD-ROM.</li> <li>If installer does not start automatically, double-click <i>setup.exe</i>.</li> <li>Follow installer prompts.</li> </ol>
3. Connect Checker 4G to power	Connect Checker 4G to 24 VDC power supply and I/O equipment, as described on page 36. Verify that Checker 4G illumination LEDs are lit.
4. Connect Checker 4G to PC	Connect Checker 4G directly to the PC using an Ethernet cable.
5. Configure Checker	<p>Start the Checker software (select <b>Cognex-&gt;Checker Vision Sensors-&gt;Checker</b> from the Windows <b>Start</b> menu).</p> <ul style="list-style-type: none"> <li>Click <b>Get Connected</b>.</li> <li>Select your Checker 4G and click <b>Connect</b>.</li> </ul> <p>The <b>Checker Configuration</b> dialog lets you configure your Checker:</p> <ul style="list-style-type: none"> <li>In the <b>Set Personality</b> pane, select <b>Presence</b> if you are using this sensor to check presence/absence or appearance. Select <b>Measurement</b> if you are using this sensor to verify part or feature dimensions.</li> <li>If are connecting Checker to a network that does not use DHCP, use the <b>Network Settings</b> pane to specify a static IP address for this Checker.</li> <li>If you are using an encoder, select <b>Encoder</b> in the <b>Set I/O Mode</b> pane.</li> </ul>

# Checker User Interface

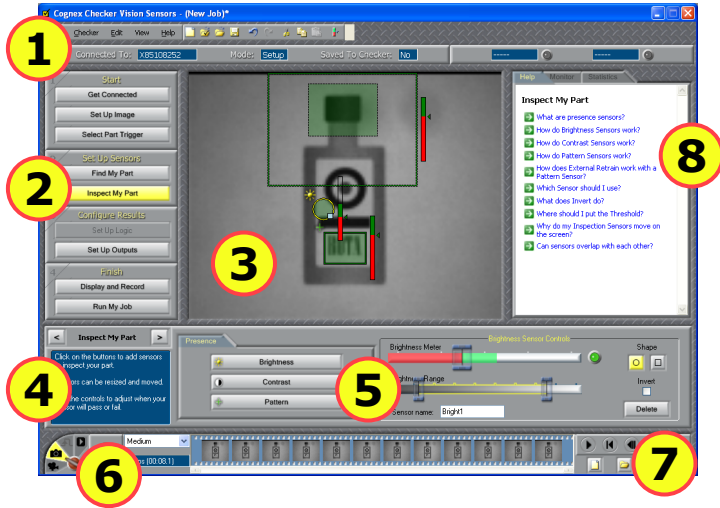

1	Menu bar and status pane. The menu bar lets you open and save jobs and manage Checker personalities and system settings. The status pane shows which Checker is connected, the Job name and if it has been saved, along with results for the most recent image.
2	Checker steps. Click each button in turn to build a Checker application.
3	Image display. Shows live video from Checker or individual images from a Filmstrip.
4	For each Checker step, instructions about what to do next are displayed here.
5	Control pane. The controls and information for each Checker step are displayed here.
6	Filmstrip recording controls: Video, Snapshot, External Trigger, and Playback mode.
7	Filmstrip playback controls (only enabled in Playback mode). Lets you load and display images recorded earlier or on another Checker.
8	Questions and answers related to the current step.

The **Checker User Interface** is PC software that lets you control Checker. You use this program to view Checker images, create and modify Checker Jobs, and to monitor running Checkers.

**Note:** To view or change Checker system configuration, including Personality, I/O Mode, and Network Settings, select **Checker->Configure Checker...** from the menu bar, then select the appropriate configuration option.

# Connecting to Checker

When the **Get Connected** step is selected, the Checker PC software displays all available Checker sensors detected on the *subnet* to which the PC is connected in the **Checkers** list. You can select any of these Checker sensors and click **Connect** to connect.

If you have a Checker sensor connected directly to the Ethernet port on your PC, that Checker is *always* displayed in the **Checkers** list.

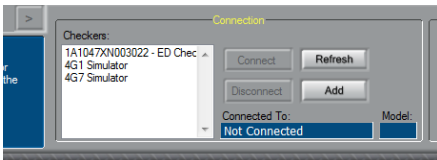

Click **Refresh** to update the list of Checkers. Click **Add** to reconfigure Checkers that do not appear in the list.

## Checker Networking Notes

- Checker sensors are shipped with DHCP enabled by default. If your network does not use DHCP, you must configure your Checker with a static IP address, as described in the next section.
- Checker PC software can *always* connect to a Checker sensor that is connected directly to its Ethernet port, regardless of how the Checker is configured.
- In order to connect to a Checker sensor on a different subnet, you must manually add the Checker based on its IP address, as described in the next section.



## Adding a Checker to the Checkers List

If you are using a network to connect to your Checker sensor and the Checker sensor that you want to connect to is not in the **Checkers** list, refer to the following table:

If...	Try this...
Checker is directly connected to your PC	Make sure that Checker is connected to power and that the green status LED is lit or blinking.
Your network does not have a DHCP server <b>and</b> your Checker and PC are on the same subnet.	Click <b>Add</b> , then select your Checker from the device list and configure it to use a Static IP address.
Your Checker and PC are <b>not</b> on the same subnet.	<ol style="list-style-type: none"><li>1. Temporarily connect your Checker directly to your PC's Ethernet port.</li><li>2. Select your Checker, then click <b>Add</b>. Select <b>Checker-&gt;Configure Checker</b> from the menu bar, then click on <b>Network Settings</b> and uncheck <b>DHCP</b> and enter a valid static IP address.</li><li>3. Reconnect your Checker and PC to the network.</li><li>4. Click <b>Add</b>, then click <b>Add by IP Address...</b> in the resulting dialog box. Enter the static IP address that you configured in Step 2, above.</li></ol> <p>The Checker should now appear in the <b>Checkers</b> list.</p>

# Part Trigger

A *part trigger* tells Checker that a part is ready to be inspected. Checker supports three trigger types.

	<b>Internal Part Trigger:</b> Checker uses its Part Finding Sensor to detect when a part is present and ready to be inspected. You create and configure the Part Finding Sensor by selecting a feature on your part that is always present.
	<b>External Part Trigger:</b> Checker uses an external signal that your equipment supplies to detect when a part is present and ready to be inspected. You use an External Trigger by configuring a device such as a photoelectric sensor, contact switch, or proximity sensor, then connecting it to Checker's Trigger input line.
	<b>Free Running:</b> Checker inspects each and every image that it acquires, not just the images that contain a part or for which an external trigger is received.

## Choosing a Trigger Type

You set the trigger type in the **Select Part Trigger** step on the PC.

In most cases, it is simplest to use the Internal Part Trigger, since no external equipment is required. You create a Part Finding Sensor in the **Find My Part** step on the PC.

If the appearance of your parts is highly variable, or if your line already has a device or sensor that produces a part trigger signal, you can use an External Trigger.

Free Running mode is useful for several types of applications:

- Checking objects that move continuously and which cannot be detected with a Part Finding sensor, such as a moving web of paper or metal.
- Checking parts that move in multiple ways, such as a part that moves into the field of view and then rotates in place.
- Performing continuous inspection of non-moving objects to check for changes in appearance.

# Part Finding Sensor

A *Part Finding Sensor* detects and locates your part in the image. You create a Part Finding Sensor by drawing a box around a feature of part that is present on both good and bad parts.

## Part Finding Sensors and Trigger Types

Part Finding Sensors are used differently for different trigger types.

- With an Internal Trigger, a Part Finding Sensor is *required*. The Part Finding Sensor tells Checker that a part is present.
- With an External Trigger, a Part Finding Sensor is optional. If you do not use a Part Finding Sensor, then the presence or measurement sensors will run in fixed positions. If you use a Part Finding Sensor, then both the Part Finding Sensor and the External Trigger must indicate a part before Checker will check it.
- In Free Running mode, a Part Finding Sensor is optional. If you do not use a Part Finding Sensor, then the presence or measurement sensors will run in fixed positions. If you use a Part Finding Sensor, then the Part Finding Sensor must detect a part in an image before Checker will check it.

In all cases, if a Part Finding Sensor is used, then Checker uses the part's detected location to position the presence or measurement sensors.

## Modifying a Part Finding Sensor

You can change the location where Checker looks for the part by simply moving the Part Finding Sensor search region.

To change *what* a Part Finding Sensor looks for, you must either

- Create a new Part Finding Sensor in Setup mode.
- Use the External Retrain feature in Setup mode or Run mode.

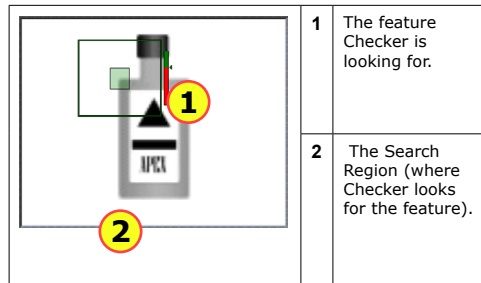

# Presence Sensors

*Presence Sensors* evaluate part of a Checker image to determine if a feature is present or not. Presence sensors support one-click setup; simply click on the feature you want to check to create and configure the sensor in a single step.

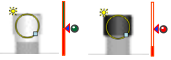
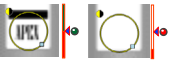
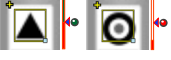
	<b>Brightness Sensor:</b> Use when the feature of a good part is much lighter or much darker than the same feature of a bad part.
	<b>Contrast Sensor:</b> Use when the feature of a good part has more or less distinct dark and light areas than the same feature of a bad part.
	<b>Pattern Sensor:</b> Use when the feature of a good part has the shape you want and the same feature of a bad part does not, or when inconsistent lighting conditions cause Brightness or Contrast sensors to fail.

## Sensor Threshold

The sensor threshold slider sets the level below which a sensor fails and above which a sensor passes. In many cases, the default value works well. If you adjust the slider, set it so that it is mid-way between the level for good parts and bad parts.

If you check **Invert**, the Sensor passes with levels below the threshold and fails with levels above the threshold.

## Modifying a Sensor

To change the location of a sensor, click and drag on the sensor border. To resize a sensor, click and drag on the handle on the sensor border. Checker automatically re-trains a Pattern sensor whenever you move or resize it.

## Advanced Sensor Tuning



Brightness and Contrast Sensors have controls that let you tune the sensors to maximize the reported difference between good and bad parts.

# Measurement Sensors

*Measurement Sensors* evaluate part of a Checker image to determine if a feature is within a specified size range.

Measurement sensors support one-click setup; simply click on the center of the feature you want to measure to create and configure the sensor in a single step.

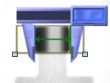
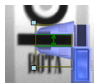
In most cases, there is no need to change the one-click setup sensor. Features that are too large or too small will fail, while features that are the correct size will pass. You use the controls shown below to adjust a measurement sensor.

	<b>Width Sensor:</b> Use to measure the width of a feature with vertical edges.
	<b>Height Sensor:</b> Use to measure the height of a feature with horizontal edges.
	<b>Diameter Sensor:</b> Use to measure the diameter of a circular feature.

## Using the Measurement Sensor Controls

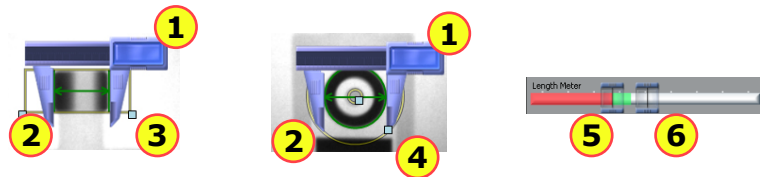

1	<b>Drag bar:</b> Click and drag here to reposition the sensor.
2	<b>Blades:</b> Click and drag here to select different feature edges.
3	<b>Width and Height Sensor Region:</b> Set the region for the feature. Use this to exclude features you don't want to measure.
4	<b>Diameter Sensor Region:</b> Set the inner and outer limits of the search region.
5	<b>Low Threshold:</b> Features smaller than this fail.
6	<b>High Threshold:</b> Features larger than this fail.



## Filmstrip Control

The Filmstrip Control lets you record and play back Checker images.

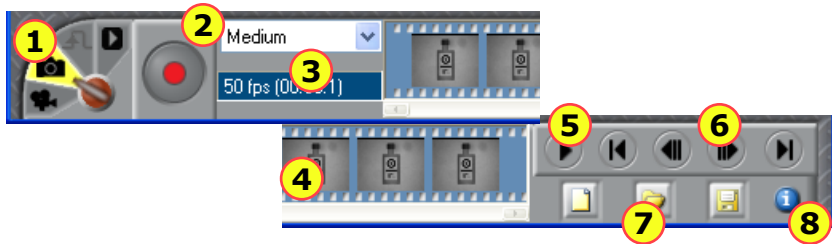

1	Filmstrip mode selector
2	Record button. Click (or press F5) to add an image to the Filmstrip.
3	Recording rate. How many images per second are added to the Filmstrip.
4	Filmstrip display. Click on an image to view it. Blue bars separate images of a single detected part (in Internal Part Trigger mode).
5	Playback button (only enabled in Playback mode). Press to start or stop image playback.
6	Filmstrip navigation buttons. Click the inner buttons to advance or rewind by a single frame. Click the outer buttons to advance or rewind by a single part.
7	Filmstrip clear, load, and save controls.
8	Information button. Hover the cursor here to view information about the selected Filmstrip image.

## Filmstrip Mode Selector

The Filmstrip mode selector controls whether the Filmstrip is recording or playing back images, and if it is recording, when images are recorded to the Filmstrip.



9	Video mode. Pressing trigger button starts or stops continuous image capture to Filmstrip.
10	Snapshot mode. Pressing trigger button adds one image to Filmstrip.
11	External Trigger mode. When an external trigger is received, an image is added.
12	Playback mode.

# Power and I/O Connector

Checker I/O can be configured in software for Job Change or Encoder mode.

Lead Color	Job Change I/O Mode	Encoder I/O Mode	Pin
RED	24 VDC +	24 VDC +	7
BLACK	24 VDC -	24 VDC -	8
VIOLET	RETRAIN	RETRAIN	5
YELLOW	JOB CHANGE	EncoderPhB +	1
WHITE/YELLOW	JOB SELECT	EncoderPhB -	2
BROWN	OUTPUT 2	EncoderPhA +	3
WHITE/BROWN	OUTPUT 3	EncoderPhA -	4
ORANGE	TRIGGER	TRIGGER	10
WHITE/VIOLET	INPUT COMMON	INPUT COMMON	6
BLUE	OUTPUT 0	OUTPUT 0	11
GREY	OUTPUT 1	OUTPUT 1	12
GREEN	OUT COMMON	OUT COMMON	9

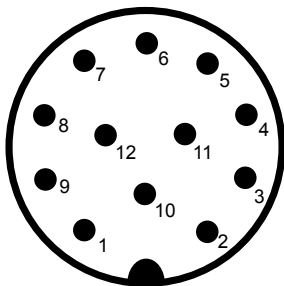

**Note:** Pin numbers for male connector on Checker 4G are shown.

When wiring Checker 4G, observe the following precautions:

- Use a listed power supply with an output rated 24 VDC, at least 250 mA, and marked Class 2, Limited Power Source (LPS). Any other voltage creates a risk of fire or shock and can damage Checker.
- Connect the cable or connector shield to earth ground.
- Pins 1, 2, 3, and 4 may be used for an encoder connection **OR** control Checker's job change function. The configuration that you set for your Checker sensor using the Checker PC software determines how those lines are used.
- To reduce the risk of damage or malfunction, route all cables and wires away from high-voltage power sources.

# Power, Trigger, and Output Wiring

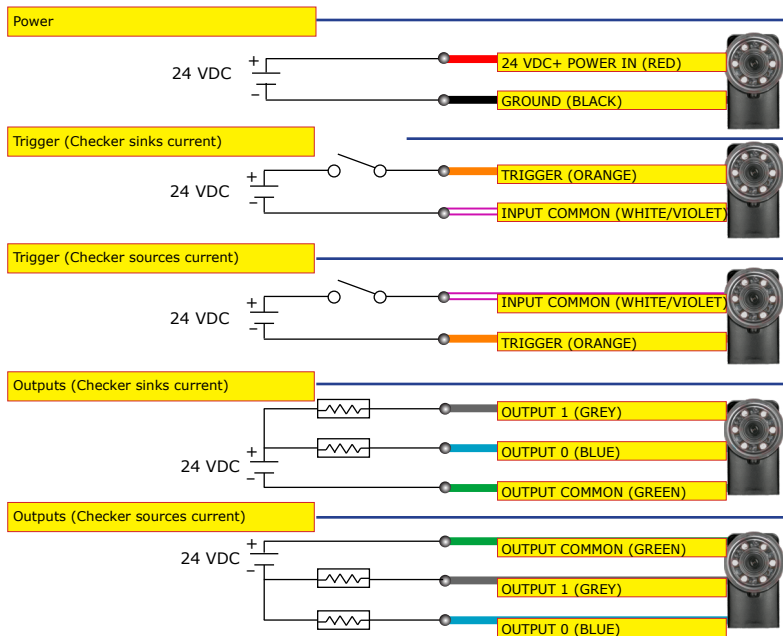

## Wiring an External Retrain Line

You can configure both Part Finding Sensors and Pattern Sensors to be retrainable by checking **External Retrain** in the sensor control panel.

Whenever Checker receives a signal on the RETRAIN line, Checker retrains any retrainable Part Finding Sensors and Pattern Sensors using the part of most recently acquired image that lies within the retrain region.

When External Retrain is enabled for a sensor, the yellow corner markers indicate the region that is used to retrain the Sensor when an External Retrain signal is received. Sensors can be retrained in both Setup mode and in Run mode. In Setup mode, can manually signal an External Retrain by selecting **Checker->Retrain** or pressing F9 on the PC.

Checker indicates that it has successfully retrained by quickly blinking its lights twice. If it could not retrain the part, it blinks its lights slowly three times. You can also configure a Checker output line to signal when an External Retrain succeeds or fails.

	Part finding sensor detects part normally.
	With a new part, the Part Finding Sensor fails.
Apply a pulse (minimum 15 ms) on RETRAIN line.	
	After retraining, Part Finding Sensor now finds new part.

## Wiring a Job Change Signal

Checker 4G has 32 *Job slots*. You can assign saved Checker Jobs to Job slots, then load them while Checker is running by sending job change signals through Checker's input lines.

You can assign a Job saved on a Checker to any Job slot by selecting **Checker->Configure Checker...** on the PC. In the **Job Control** pane, each Job slot, from 0 through 31, has a menu that you use to specify the Job. You can specify the same Job for multiple slots.

To load a Job from a Job slot while Checker is in Run mode, you must apply +24 VDC to the JOB CHANGE line, then send a series of pulses of at least 1 msec on the JOB SELECT line, then remove the voltage from the JOB CHANGE line. Checker counts the pulses received on the JOB SELECT line during the time that JOB CHANGE is held high, then loads the specified job slot.

Checker indicates that a Job Change succeeded by flashing its lights twice quickly. A failed Job Change is indicated by three slow flashes. You can also configure a Checker output line to signal when a Job Change succeeds or fails.

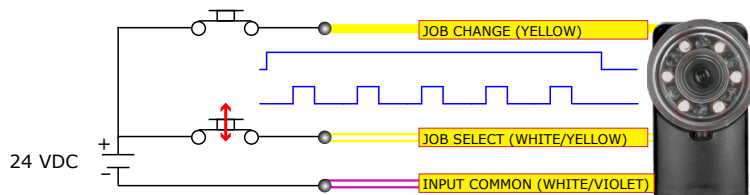

- ▶ The maximum pulse rate is 500 Hz. The minimum pulse width is 1.0 msec. The minimum interval between pulses (falling edge to rising edge) is 1.0 msec. The minimum interval from the rising edge of the JOB CHANGE signal to the rising edge of the first JOB SELECT pulse is 1.0 msec; the minimum interval from the falling edge of the last JOB SELECT pulse to the falling edge of the JOB CHANGE signal is 1.0 msec.

# Wiring an Encoder

If your Checker 4G is configured for encoder input, you can connect both differential and single-ended encoders. Using an encoder allows you to specify input and output delay values in pulse counts instead of real time units.

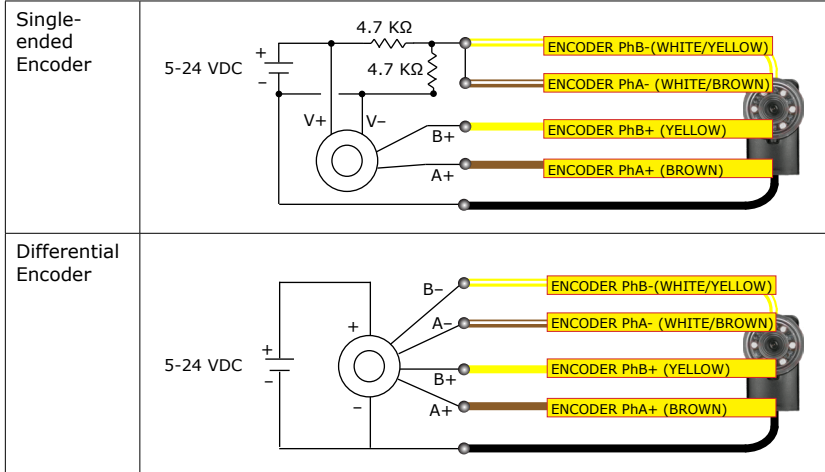

# Checker I/O Circuits

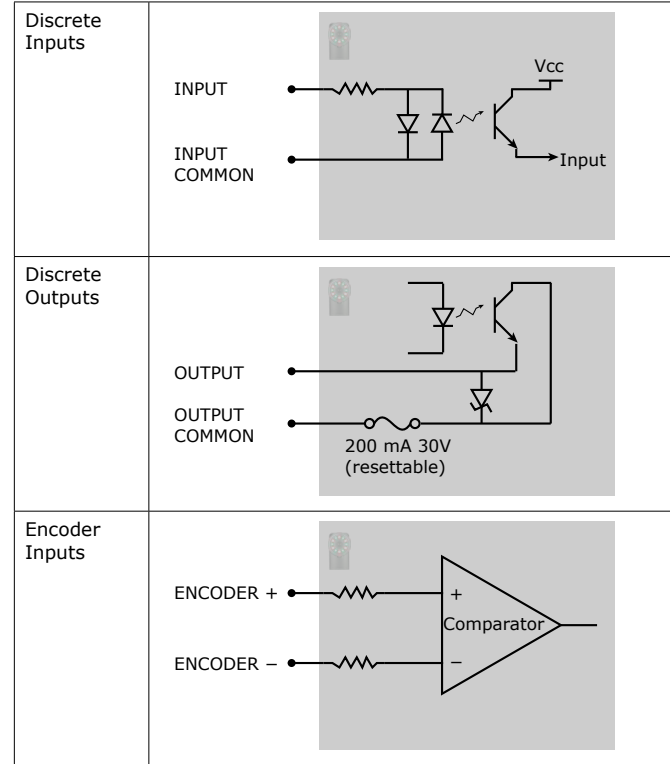

# Mounting Checker

- ▶ **Caution: Do not use a mounting screw with an exposed thread depth of greater than 5mm. Allowing the mounting screw to bottom in the mounting hole can damage Checker.**
- ▶ **Caution: The maximum torque for a mounting screw is 1.8 nM (16 inch-pounds). Exceeding this torque value can damage Checker.**

Mounting Checker at a slight angle can reduce reflections from your part's surfaces, improving performance. Adjust the mounting angle to provide the clearest image of the part features you are checking.

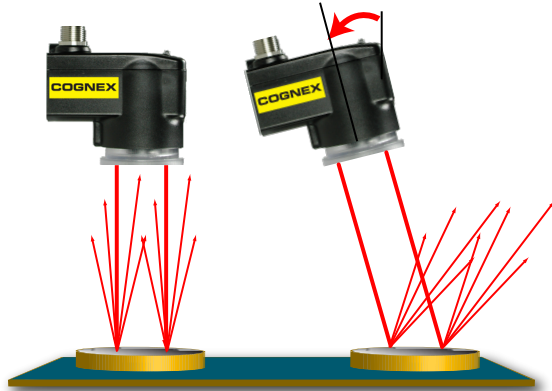

The optional Checker mounting bracket lets you easily position and adjust Checker on your line.

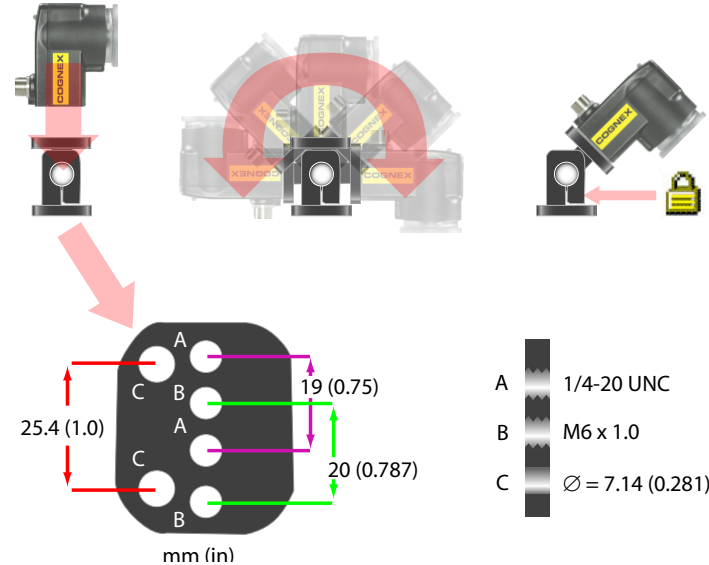

## Working Distance and Field of View

The distance from Checker's lens cover to your part is the working distance; the field of view is what Checker can see at that distance. As the working distance increases, so does the size of the field of view.

These charts show the field of view provided by the standard 5.8mm lens at various working distances, as well as the fields of view provided by the lenses included in the optional Checker Lens Kit (CKR-200-LENSKIT).



Checker 4G1

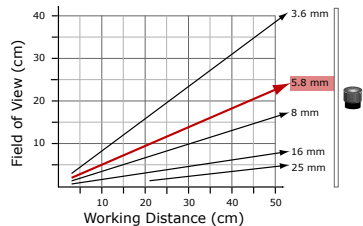

Checker 4G7

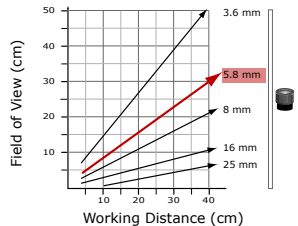
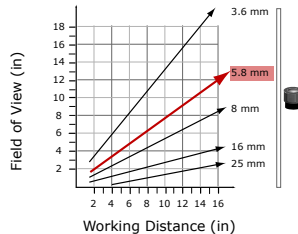

## Adjusting Focus

Adjust focus using the clear ring on Checker. Using the supplied 2.5 mm hex key, you can lock the focus adjustment by tightening the focus lock. The lens cover both seals the front of Checker and lets you adjust the lens focus.



1	Clearer
2	More distant
3	Focus lock

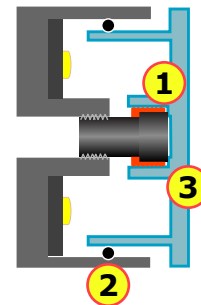

1	Locking nut secures lens to lens cover.
2	Large O-ring seals lens cover to Checker housing.
3	Lens cover rotates lens, adjusting focus.

## Changing Lenses

To remove the Checker lens, follow the steps listed below.

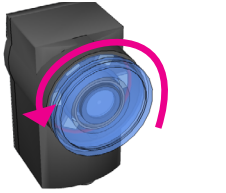
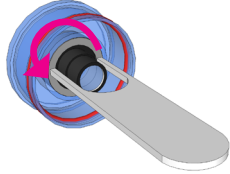
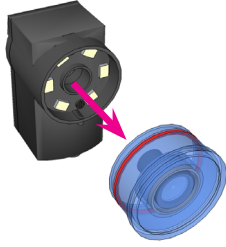
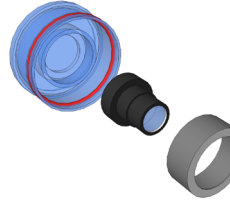

<p>1. Unscrew lens cover. Lens is secured to lens cover by threaded locking ring.</p>		<p>3. Using supplied key, unscrew locking ring from back of cover.</p>	
<p>2. When lens is fully released, remove cover with lens in place.</p>		<p>4. Separate lens from cover and locking nut.</p>	

To install the Checker lens, reverse the order of the steps listed above. Rotate lens cover to adjust Checker focus.

**Note:** Do not overtighten locking ring.

## Installing and Removing Filters and Lights

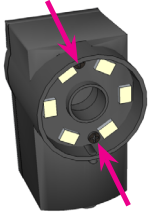
To replace Checker's built-in lighting module, first remove the lens and lens cover, as described in steps 1-2 on the preceding page, then follow the steps listed below.

<p>1. Unscrew and remove the two retaining screws .</p>		<p>Remove the lighting module.</p>	
---	---	------------------------------------	---



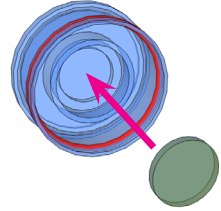
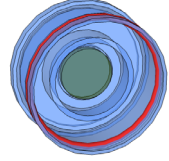

To install the lighting module, reverse the order of the steps listed above. Note that the module is keyed and may only be inserted at one orientation.

To install a filter in Checker, first remove the lens as described in steps 1-4 on the preceding page, then follow the steps listed below:

<p>1. Place the filter in the center of the lens cover.</p>		
---	---	---

Re-install the lens and locking ring, then re-attach the lens and cover to the Checker.

# Specifications

Cable	24AWG, 5 m, M12 connector (power and I/O)
Power requirements	<b>Voltage:</b> +24 VDC (22-26 VDC) <b>Current:</b> 250 mA max
Discrete Inputs	<b>Input ON:</b> > 10 VDC ( $\geq 6$ mA) <b>Input OFF:</b> < 2 VDC ( $\leq 1.5$ mA) <b>Protection:</b> Opto-isolated, polarity-independent
Encoder Inputs	<b>Differential:</b> A+/B+: 5-24V (50 kHz max) A-/B-: Inverted(A+/B+) <b>Single Ended:</b> A+/B+: 5-24V (50 kHz max) A-/B-: VDC = $\frac{1}{2}$ (A+/B+)
Discrete Outputs	<b>Output:</b> Solid state switch <b>Rating:</b> 100 mA, 24 VDC Max <b>Max voltage drop:</b> 3.5 VDC @ 100 mA <b>Max load:</b> 100 mA <b>Protection:</b> Opto-isolated, protected from short circuit, overcurrent, and reverse polarity.
24V power fuse	500 mA, 60 V rated resettable fuse that will recover after an overload is removed. Protects against over voltage and reverse wiring.
Output fuse	200 mA, 30 V rated resettable fuse that will recover after an overload is removed. Protects each output from over current.
Weight	3.5 oz. (100g)
Environmental limits	Operating temperature: 32° to 122°F (0° to 50°C) Storage temperature: -22° to 176°F (-30° to 80°C) Operating humidity: 0% - 90% non-condensing Maximum operating altitude: 4000 meters Protection: IP67 Pollution degree: 2
Shock	80Gs for 5ms on each axis (per IEC 68-2-2)
Vibration	10Gs (10-500Hz) at 100 M/sec <sup>2</sup> / 15mm for 2 hours in each axis (per IEC 68-2-6)
Certification	    

# Precautions

Observe these precautions when installing Checker to reduce the risk of injury or equipment damage:

- **Do not use Checker in applications where an incorrect or absent output signal could cause human injury.**
- Do not stare directly into the Checker LED illumination.
- Checker is intended for indoor use only.
- Do not attempt to adjust Checker's focus when moving parts and/or equipment are present.
- Use a listed power supply with an output rated 24 VDC, at least 250 mA, and marked Class 2, Limited Power Source (LPS). Any other voltage creates a risk of fire or shock and can damage Checker.
- Connect the cable shield to earth ground.
- A Cognex-supplied, IP67-rated M12 Ethernet cable must be fitted to the Ethernet connector for Checker to meet the IP67 protection standard.
- Do not install Checker in locations that expose it to environmental hazards such as excessive heat, humidity, impact, vibration, corrosive substances, flammable substances, or static electricity.
- To reduce the risk of damage or malfunction, route all cables and wires away from high-voltage power sources.
- Do not extend I/O and power cables longer than 30 meters.
- Make sure that the mounting screws do not bottom in the mounting holes; using too long a mounting screw can damage Checker.
- Do not attempt to modify Checker. Modifications will void the warranty.



NOTE: This equipment has been tested and found to comply with the limits for a Class A digital device, pursuant to Part 15 of the FCC Rules. These limits are designed to provide reasonable protection against harmful interference when the equipment is operated in a commercial environment. This equipment generates, uses, and can radiate radio frequency energy and, if not installed and used in accordance with the instruction manual, may cause harmful interference to radio communications. Operation of this equipment in a residential area is likely to cause harmful interference in which case the user will be required to correct the interference at his own expense.

## ITE Certification Notice

Class	User Guide
A	Please note that this equipment has obtained EMC registration for commercial use. In the event that it has been mistakenly sold or purchased, please exchange it for equipment certified for home use.
B	As this equipment has obtained EMC registration for house hold use, it can be used in any area including residential area.

Copyright © 2011 Cognex Corporation All Rights Reserved. This document may not be copied in whole or in part, nor transferred to any other media or language, without the written permission of Cognex Corporation. Cognex, the Cognex logo, Checker, and the Checker logo are trademarks, or registered trademarks, of Cognex Corporation.

This product is covered by one or more of the following US patents and one or more pending US and foreign patents, which, when issued are listed on the Cognex web site at <http://www.cognex.com/patents>.

5583954, 5602937, 5964844, 6215915, 6381375, 6421458, 6931602, 7305114, and 7417803

