

LFR-200-SW/-GR/-BL

Model	LFR-200-SW/-GR/-BL
Voltage	24V DC
Power consumption	11W
Mass	490g
Connector type	3P (1: +, 2: NC, 3: -)

Third Angle Projection Units: mm

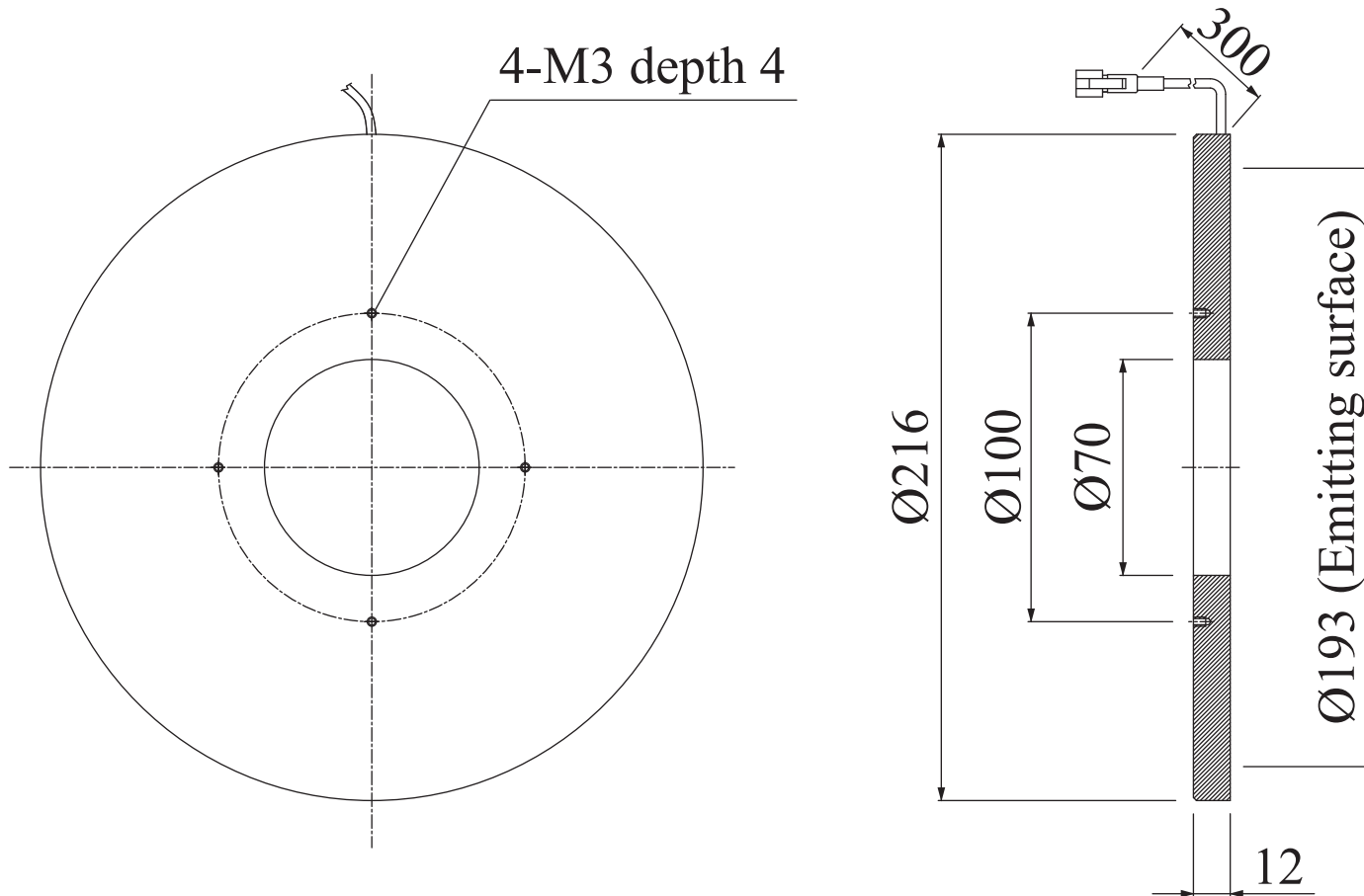



Flat-ring Lights

LFR/LKR Series

Evenly diffused top lighting

Overhead diffuse light eliminates LED glare and shadows for even illumination



Thin flat ring using CCS light conduction

The LEDs are arranged on a flexible board in a straight line, and then wrapped around the perimeter of a light diffusion plate. This channels the light directly from the LEDs into the light diffusion plate.

In addition, a reflective film is applied to the surfaces of the light diffusion plate to refract and scatter the light in a complex way after it is introduced from the emitters. The light will spread evenly through the entire light diffusion plate and produce a very even light distribution.

Patent Pending

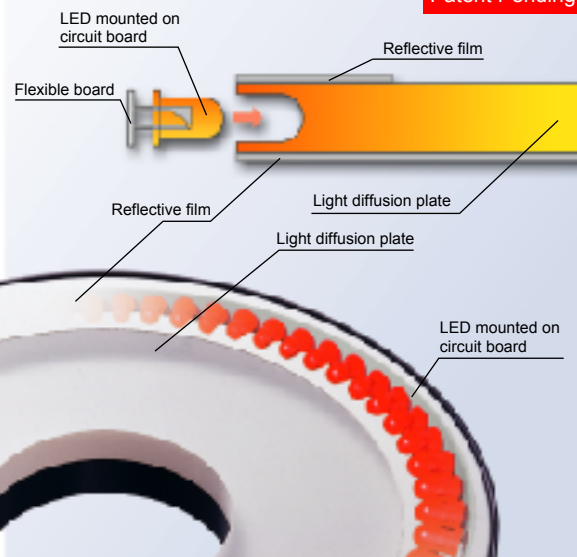

Even illumination without shadows (LKR)

LKR Series. Light shines from the conical emitting surface at all angles, making it possible to evenly illuminate the work without forming shadows.

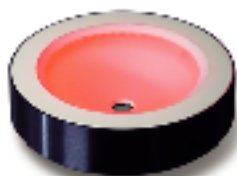

LKR-70-8

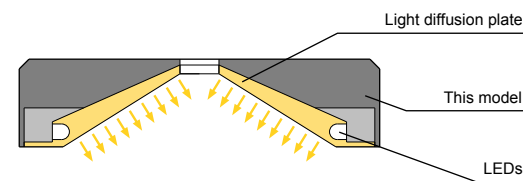

Solder joint inspection for chip components on printed circuit board.
FOV 10mm, LWD 10mm
No hot spots, uniform illumination, only the solder joints stand out in white.
Lighting: LKR-70A

Product Lineup Table

Series	Model Name	Color	Power Consumption	Options	Dimension
LFR	LFR-100	●	12V/3.6W	—	1 □
	LFR-100-SW/-GR/-BL	○/●/●	24V/4.9W	—	—
	LFR-100K	●	12V/3.6W	—	2
	LFR-100K-SW/-GR/-BL	○/●/●	24V/4.9W	—	—
	LFR-130	●	12V/4.5W	—	3
	LFR-130-SW/-GR/-BL	○/●/●	24V/6.1W	—	—
	LFR-130K	●	12V/4.5W	—	4
	LFR-130K-SW/-GR/-BL	○/●/●	24V/6.2W	—	—
	LFR-200	●	12V/7.8W	—	5
	LFR-200-SW/-GR/-BL	○/●/●	24V/11W	—	—
	LFR-250	●	12V/9.0W	—	6
	LFR-250-SW/-GR/-BL	○/●/●	24V/14W	—	—

Series	Model Name	Color	Power Consumption	Options	Dimension
LFR	LFR-330	●	12V/14W	—	7
	LKR-70A	●	12V/3.0W	—	8
LKR	LKR-70A-SW/-GR/-BL	○/●/●	24V/4.1W	—	—
	LKR-70-8	●	12V/3.0W	—	9
	LKR-70-8-SW/-GR/-BL	○/●/●	24V/4.1W	—	—
	LKR-125	●	12V/4.5W	—	10
	LKR-125-SW/-GR/-BL	○/●/●	24V/6.1W	—	—

Dimensions (Unit: mm)

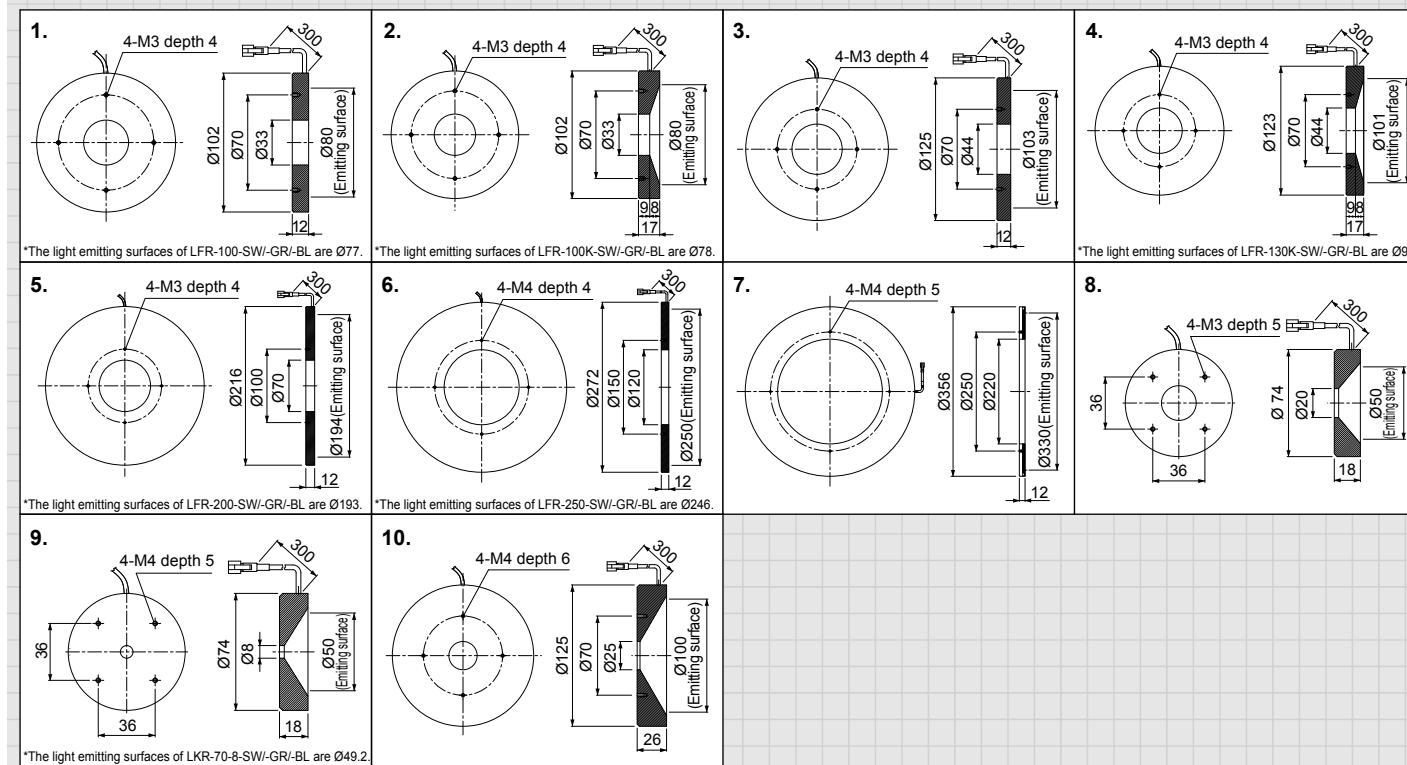

CCD Sensitivity Chart and Brightness Distribution LFR-130

Although the level of brightness is not high, the LFR-130 has excellent uniformity and is capable of astral lighting over a broad range.

CCD intensity vs LWD

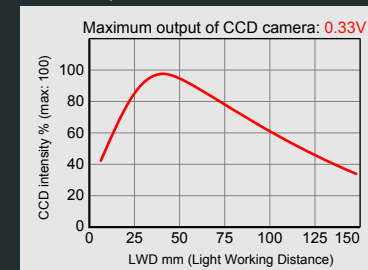

LWD: 50mm

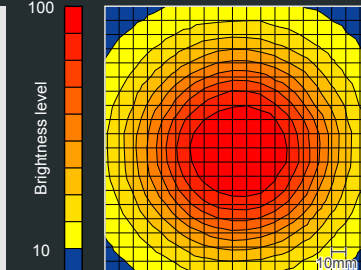

LWD: 100mm

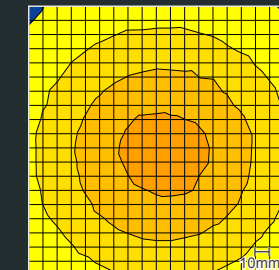

LWD: 150mm

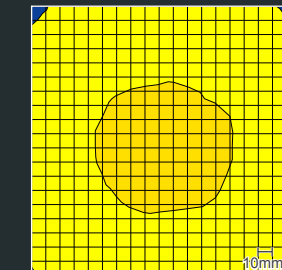

CCD Sensitivity Chart and Brightness Distribution LKR-70A

The center of the light has a conical light-emitting surface to deliver bright and even illumination, allowing the object to be evenly illuminated without producing shadows.

CCD intensity vs LWD

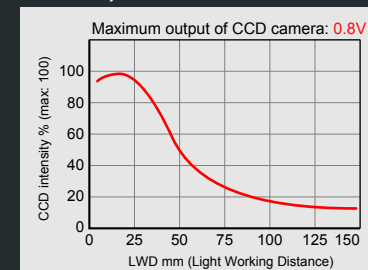

LWD: 10mm

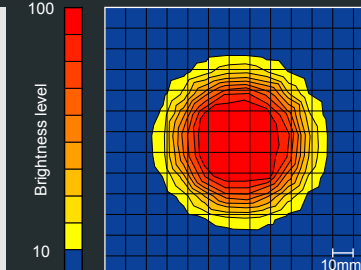

LWD: 15mm

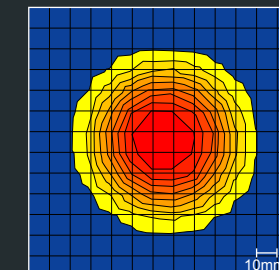

LWD: 20mm

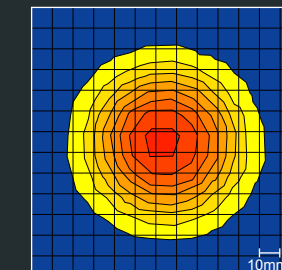

Illumination structure of LFR-100

Light from the LEDs around the periphery of the light diffusion plate is scattered and reflected within the plate to create diffuse light that illuminates from directly overhead.

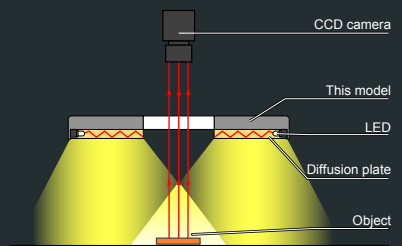

Examples of Flat Ring Illumination Images

Inspecting for nicks on a glass bottle

Normal areas of the bottle appear illuminated as a white ring. Broken parts can be detected as dark spots within the rings.

Light used: LFR-100

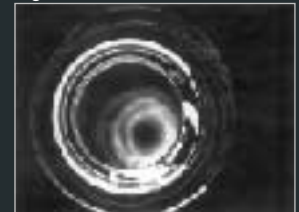

Inspecting characters on a QFP package

The characters are illuminated with good contrast.

Light used: LFR-130

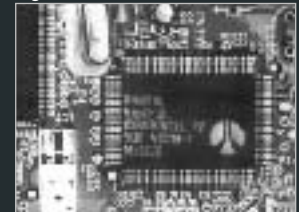

Inspecting of stains on plastic caps

The stains on inside and bottom face of plastic caps can be detected.

Light used: LKR-70A

