

# TRsystems Drill Quality Assurance Product Information BQS



## TR-Electronic – Your Partner in Automation

















TR-Electronic can look back on more than 25 years of success, and is represented worldwide with an export share of more than 40 %. The core business comprises the development and manufacture of industrial angular and position measuring technology, as well as compact drive technology with integrated position control and measurement. The company is divided into three Business Units (BU) and is thus well positioned for further growth in the future.

Products in the **Rotary Encoder Business Unit** with optical or magnetic scanning precisely acquire position in steel production, wind power plants, cranes and ships as well as in explosion-proof versions in painting lines. Miniature versions ensure the correct position in medical technology. SIL3 approved absolute rotary encoders ensure the necessary safety.

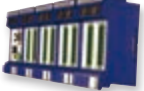
In the **Linear Encoders Business Unit** magnetostrictive position sensors position injection molding machines, for example, or are directly integrated into hydraulic cylinders. Cascadable distance measurement sensors position parting units. With their high precision, glass scales on machine tools ensure precise position. Laser sensors based on phase difference measuring techniques position aisle stackers in warehousing and materials handling technology.

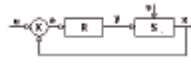
In the **Drives Business Unit** angle sensors are combined with compact drives: no external electronics are required, position, speed and torque controllers, power electronics and absolute rotary encoders are compactly integrated into the drive and thus bring intelligence directly to the drive shaft via the field bus. Compact drives are used for diverse applications in the printing and packaging industry and on palletizers.



| Rotary Encoder                                                                                                                                                                                                                                                                                                                    | Linear Encoder                                                                                                                                                                                                                                                                                                                                                                                                                  | Drives                                                                                                                                                                                                                                                                                                                 | Components                                                                                                                                                                                                                                                                                                     | Engineering                                                                                                                                                                                                        | Unidor                                                                                                                                                                                                                                                                                                                                                                 |
|-----------------------------------------------------------------------------------------------------------------------------------------------------------------------------------------------------------------------------------------------------------------------------------------------------------------------------------|---------------------------------------------------------------------------------------------------------------------------------------------------------------------------------------------------------------------------------------------------------------------------------------------------------------------------------------------------------------------------------------------------------------------------------|------------------------------------------------------------------------------------------------------------------------------------------------------------------------------------------------------------------------------------------------------------------------------------------------------------------------|----------------------------------------------------------------------------------------------------------------------------------------------------------------------------------------------------------------------------------------------------------------------------------------------------------------|--------------------------------------------------------------------------------------------------------------------------------------------------------------------------------------------------------------------|------------------------------------------------------------------------------------------------------------------------------------------------------------------------------------------------------------------------------------------------------------------------------------------------------------------------------------------------------------------------|
| <br>Incremental Encoder<br><br>Absolute Encoder<br><br>Draw Wire Encoder | <br>Magnetostriction<br><br>Glass scale<br><br>TOF laser<br><br>Barcode Positioning | <br>Actuator<br><br>Positioning Drive<br><br>Processing Drive | <br>I/O Module<br><br>Controls<br><br>Industrial-PC | Automation Solutions<br><br>Retrofit<br> | Punching and forming Measurement and control systems<br><br>Sensors<br><br>Process monitoring tools<br> |

The portfolio is supplemented by the affiliated TRsystems with customized controls, industrial PCs, hydraulic controls as well as control units and sensors for punching and forming.

An essential factor for the success of TR-Electronic are the now more than 300 employees who actively help to shape the product portfolio with innovations and successfully implement customer projects. Through its commitment to the regional colleges, TR-Electronic supports the high quality training of young employees and thus guarantees the highest level of innovation and quality at its Trossingen location.

A high degree of vertical integration allows customer-specific requirements to be responded to very quickly. The constantly new requirements on the mechanical design of sensors, on innovative new operating interfaces and new plug connectors result in a rapidly increasing product diversity. With TR-Electronic you have a partner who can fulfil these requirements.

## Content

|                                                                              |   |
|------------------------------------------------------------------------------|---|
| General – Your Partner in Automation                                         | 2 |
| System Case                                                                  | 3 |
| BQS 224 Drill Quality Assurance System – For Drill Quality Assurance System  | 4 |
| BQS 224 Sensor – Equipment and Function, Electromagnetic Compatibility (EMC) | 5 |
| BQS Control I/O – Equipment and Functions                                    | 6 |
| BQS Control I/O – Initial Operation / Terminal Pin Assignment                | 7 |

## System Case

The system case contains all necessary components for a fully functional BQS system. All components from this case are 100 %

harmonized and form one complete unit. You can also order individual components from us at any time by quoting the item number.



### Parts List: System Case (792-10006)

| Description:                    | Item No.:   |
|---------------------------------|-------------|
| Connection cable 2 m            | 620 001 587 |
| Connection cable 5 m (optional) | 62 000 1614 |
| ISR. countersunk screw M4×10    | 27 003 037  |
| Bus connector (optional)        | 62 005 278  |
| Allen wrench SW 1.5             | 49 930 050  |
| USB cable 1 m (firmware update) | 64 070 427  |
| Flash drive (USB 2.0)           | 68 000 019  |

|                                         |            |
|-----------------------------------------|------------|
| BQS Control I/O                         | 792-10005  |
| BQS 224 Sensor                          | 792-10001  |
| Collet chuck BQS drill breakage control | 49 931 006 |
| BQS flange plate 30 × 5 × 50 mm         | 49 931 007 |
| BQS paddle (test needle)                | 49 931 005 |

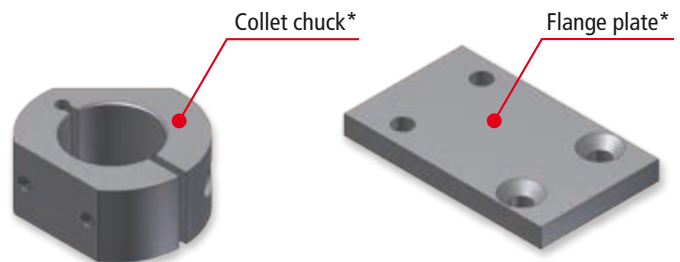

\*Recommended manufacturer's retaining system

## Drill Quality Assurance System

The BQS system will reliably scan your tool or workpiece for presence and scale. It is a sensible addition to any turning and milling machine and/or all machining centres.

When we developed this system, we focused primarily on our customers' requirements. Some of these requirements related to the BQS 224 Sensor, others to the compact BQS Control I/O.

This optimized quality monitoring system offers you a long service life, robustness, impermeability, diversity and reliability right from the beginning.



### Possible Areas of Application:

- \_ Is the tool present?  
Tool presence
- \_ Is the tool complete?  
General breakage monitoring
- \_ Is the tool in the right place?  
Position definition / clamping error detection
- \_ Is there an obstacle between the tool and the workpiece?  
Free space monitoring
- \_ Is the workpiece present?  
Object recognition
- \_ Can the next workpiece be inserted?  
Ejection monitoring
- \_ Can the next cycle be started?  
Process monitoring

### Goals:

- \_ Prevent production loss
- \_ Prevent destruction of tools or parts
- \_ Shorten downtime
- \_ Recognize trends early
- \_ Minimize rejects
- \_ Support manufacturing process
- \_ Eliminate consequential losses

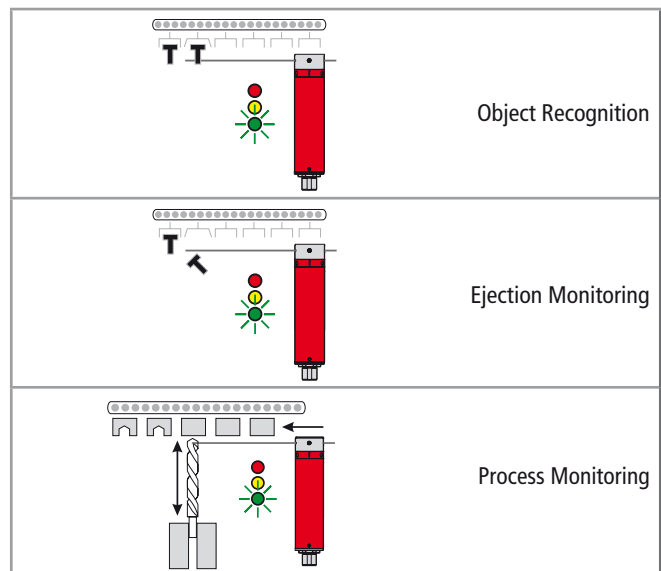
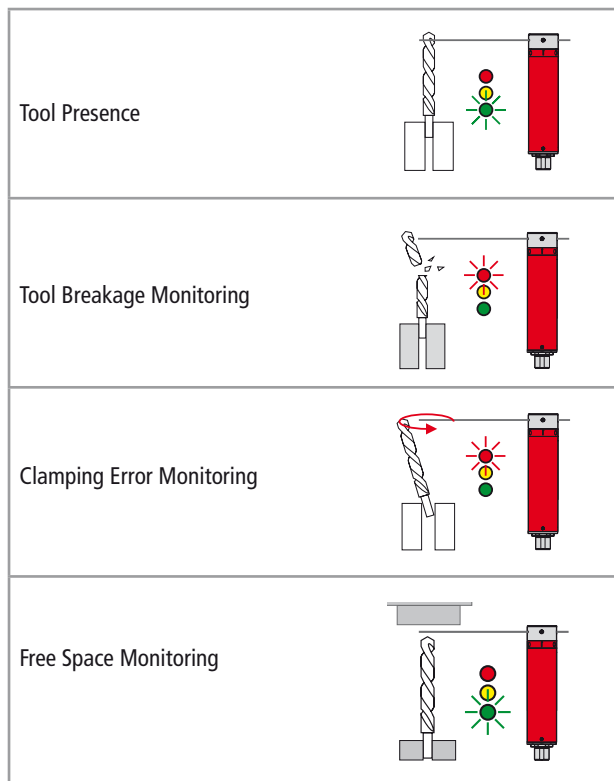

## Quality Assurance

Thanks to a multi-stage sealing system, TRsystems' drill quality control is capable of meeting all the requirements of classic metal processing: emulsions, lubricants, aggressive coolants, respirable dust and chips cannot harm the BQS 224 Sensor. With up to 10 million cycles, the BQS 224 Sensor offers a very long service life. The scanning wand's collet features a diameter of 1.2 mm and can be adjusted to a variable length of 165 mm max.

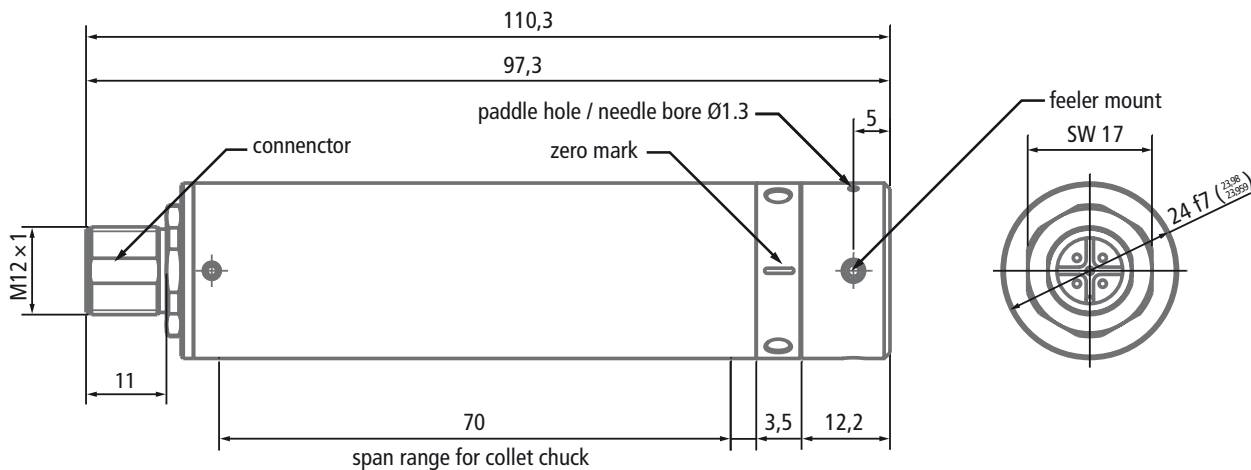
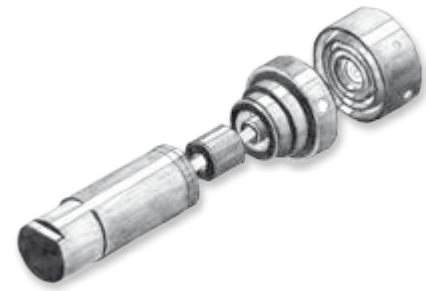

### Technical Data

|                          |                         |
|--------------------------|-------------------------|
| Protection class         | IP 68                   |
| Housing                  | Aluminium (anodized)    |
| Service life             | up to 10 million cycles |
| Scanning angle           | 15° ... 300° both sides |
| Immunity to interference | DIN EN 61000-4-4        |
| Ambient temperature      | 0 ... 80 °C             |

### Characteristics

- + Very long service life (up to 10 million cycles)
- + Multi-stage sealing concept
- + Labyrinth seal with integrated cleaning function
- + Sintered bearing for greater radial accuracy
- + Durable materials (anodized)
- + External markings on stopper
- + Fixed starting position
- + Compact design
- + External diameter only 24 mm
- + Protection class IP 68
- + Service-friendly assembly

### Dimensions

|                             |          |
|-----------------------------|----------|
| Length                      | 236.5 mm |
| Diameter                    | 24 mm    |
| Weight (with tactile probe) | 128.8 g  |

## Electromagnetic Compatibility (EMC)

Applied Standards for BQS 224 Sensor and BQS Control E/A:

|                  |                                                                       |
|------------------|-----------------------------------------------------------------------|
| DIN EN 61000-4-2 | Electrostatic discharge immunity test                                 |
| DIN EN 61000-4-3 | Radiated, radio-frequency, electromagnetic field immunity test        |
| DIN EN 61000-4-4 | Electrical fast transient/burst immunity test                         |
| DIN EN 61000-4-5 | Surge immunity test                                                   |
| DIN EN 61000-4-6 | Immunity to conducted disturbances, induced by radio-frequency fields |

## Equipment and Function

The drive actuation is implemented in a manner that is compatible with the developed control and evaluation unit. The control configuration is intuitive and easy to operate. A clearly arranged front panel shows and describes the individual connections, switches and scanners. The control unit features a USB 2.0 and an Ethernet interface. The USB 2.0 interface allows for quick firmware upgrading.

The Ethernet interface provides the option to install the update or configurations via a web interface. With machines or control units that are difficult to access, this option makes updating a lot easier.

If neither update nor a configuration via the web browser is required, one can easily get by without a PC.

Rotational direction, scan mode, output signal and scanning force can be adjusted via the DIP switch settings. With the dip switch you can determine the scanning area doing the teach-in phase.

### The Firmware Update Function

When keeping the "Teach" button pressed, the control system starts in configuration mode. The update can now easily be installed using the included software. Afterwards, a restart is necessary by disconnection and connecting the operating voltage.

### Mode of Operation

To prevent the BQS 224 Sensor from hitting the test specimen with unbroken force, the sensor can be adjusted to the expected position of the test specimen by using the rotary switch.

Using the start signal of the BQS 224 control I/O, the test needle will be gently accelerated to maximum speed from its 0 position. It will only slow down just before the measuring point. From then on, the sensor needle will scan the taught-in intermediate area as per the previously set mode.

Due to the galvanic isolation, the input signals may also be operated by a more remote control via a separate power supply. The output rating of 12 Watt is dimensioned adequately to control the 24V relay and the vertical gate.

All relevant output signals are simultaneously visualized by LED displays. These displays will remain illuminated while the associated output signals are present. The display duration must not be less than 700 ms. For example, the successful saving of a teach-in position is clearly marked by the OK-LED blinking once.

### Integrated Dual Mode Operation

Another advantage of BQS Control I/O is the dual-mode operation. It enables to properly react to different drill bit sizes. During operation, the scanning intensity can be switched by pressing dip switch No. 4.

### Examples, Showing Free-Space Monitoring (Range of movements 180°)

Mode 1 – small drills and fine scanning

The scanning speed in Mode 1 is lower than in Mode 2. Therefore, we have an increased precision in scanning. This mode is perfectly suitable for drill bit sizes less 3 mm.

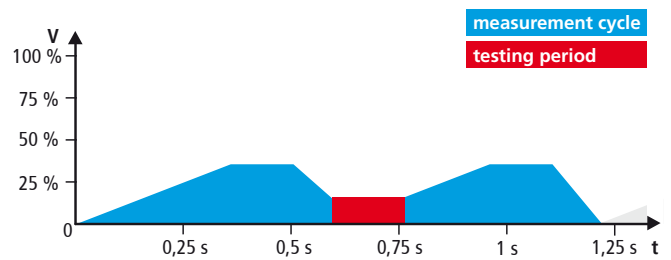

Mode 2 – quick clock cycles

In Mode 2, the scanning speed is significantly higher. This results in shorter cycle times and is particularly suitable for drills bit sizes of 3 mm and up.

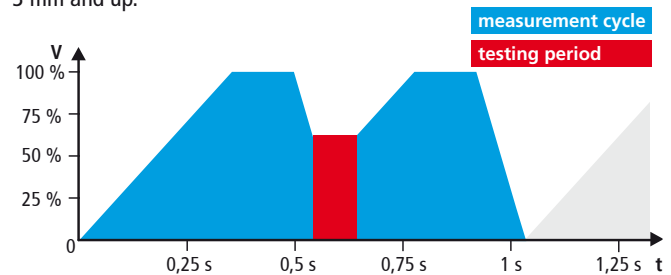

### Your Benefits

- + Integrated dual mode operation
- + Simple handling
- + Compact design
- + DIN rail mounting collet
- + Cable break-detection
- + USB 2.0 – upgradable
- + LED Display Power, OK, KO, Error
- + 4 digital inputs
- + 4 digital I/O (programmable)
- + 12 W switching power
- + Outputs are short-circuit-proof



### Technical Data

|                          |                                                              |
|--------------------------|--------------------------------------------------------------|
| Interfaces               | 4 inputs and outputs; USB 2.0; RJ45                          |
| Mode 1<br>Mode 2         | For small drills and fine scanning<br>For quick clock cycles |
| Scanning Angle           | 15° ... 300°                                                 |
| Immunity to Interference | DIN EN 61000-6-2<br>DIN EN 61000-6-4                         |
| Operating Temperature    | 0 ... 50 °C                                                  |

### Dimensions

|        |          |
|--------|----------|
| Length | 113.6 mm |
| Width  | 22.6 mm  |
| Height | 99 mm    |
| Weight | 133.8 g  |

## BQS Control I/O – Initial Operation

### Installation – Quite Simple without PC!

\_ Now connect the sensor to X5/1-5:

- 1 = grey
- 2 = brown
- 3 = white
- 4 = blue
- 5 = black

\_ First of all, the power supply has to be connected to X4/1 GND and X4/2 +24 VDC.

\_ PWR-LED on.

The digital inputs and outputs at X6 are galvanically isolated. If you don't want to operate the control inputs via another power source, you'll have to bridge to X6/3 GND\_Ext and X4/1.

### Test Start

\_ Connect your machine signal for the test process to X6/5.

\_ Connect the signal for the automatic teach-in process via the machine control to X6/4.

\_ Connect the outputs from which you want to read feedback as desired, X7/5 for OK, X7/4 for KO or X7/1 for Error.

This concludes the installation. Now, the control needs to be configured.

### Configuration

First of all, the DIP switches need to be set.

1. Left-hand/right-hand sensor rotation
2. Object/free space monitoring
3. Inverting the output signal
4. Mode 1: for small drills and fine scanning  
Mode 2: for quick clock cycles

### Putting into Operation

If these steps have been completed, the preparations for the teach-in process can begin. Using the rotary control switch to choose a sufficiently large range of movement. It is important to select an angle no larger than the observed area so the associated cycle of movement will be carried out properly.

The teach-in process can now be started. To do so, push the "TEACH IN" button (yellow) and observe the OK LED. It will blink twice in rapid succession once the teach-in process has been completed successfully and the position has been saved.

Now, only the PWR-LED is illuminated, and the scanning operation may be started.

As soon as the X6/5 input receives a digital high signal (+24V DC), the sensor will gently accelerate to maximum speed from its 0 position. Once the tolerance window has been reached, the BQS 224 Sensor will slow down and start scanning the tolerance window in a precise manner.

The result will be visualized by the control's LEDs and electronically rendered at the outputs X7/5 for OK, X7/4 for KO or X7/1 for Error.

### BQS Control I/O– Terminal Pin Assignment

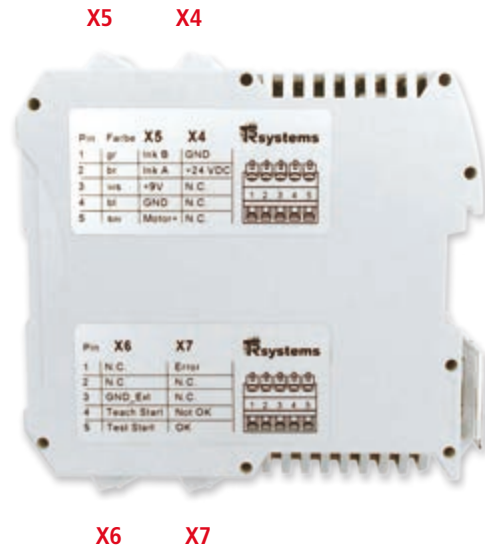

| X5 | Sensor Connection |
|----|-------------------|
| 1  | Grey              |
| 2  | Brown             |
| 3  | White             |
| 4  | Blue              |
| 5  | Black             |

| X4 | Power Supply |
|----|--------------|
| 1  | GND (0V)     |
| 2  | US (+24 VDC) |
| 3  | n.c          |
| 4  | n.c.         |
| 5  | n.c.         |

| X6 | I/O (Galvanically Isolated) |
|----|-----------------------------|
| 1  | n.c.                        |
| 2  | n.c.                        |
| 3  | GND_Ext                     |
| 4  | Teach Start                 |
| 5  | Test Start                  |

| X7 | Switching Outputs |
|----|-------------------|
| 1  | Error             |
| 2  | n.c.              |
| 3  | n.c.              |
| 4  | K.O.              |
| 5  | O.K.              |

### Notes

---

---

---

---

---

---

---

---

---

---

---

---

---

---

---

---

---

---

---

---

---

---

---



Copyright by TR-Electronic. All rights reserved - TRS-V-PP-CB-0001-01 - April 2013

**TRsystems GmbH**  
Eglishalde 16  
D-78647 Trossingen

Tel. +49 (0)7425/228-0  
Fax +49 (0)7425/228-34  
info@trsystems.de

[www.TRsystems.de](http://www.TRsystems.de)