

COGNEX

In-Sight[®] 7600/7800 Series Vision System

Reference Guide

10/10/2017

Version: 5.5.0.62

Legal Notices

The software described in this document is furnished under license, and may be used or copied only in accordance with the terms of such license and with the inclusion of the copyright notice shown on this page. Neither the software, this document, nor any copies thereof may be provided to, or otherwise made available to, anyone other than the licensee. Title to, and ownership of, this software remains with Cognex Corporation or its licensor. Cognex Corporation assumes no responsibility for the use or reliability of its software on equipment that is not supplied by Cognex Corporation. Cognex Corporation makes no warranties, either express or implied, regarding the described software, its merchantability, non-infringement or its fitness for any particular purpose.

The information in this document is subject to change without notice and should not be construed as a commitment by Cognex Corporation. Cognex Corporation is not responsible for any errors that may be present in either this document or the associated software.

Companies, names, and data used in examples herein are fictitious unless otherwise noted. No part of this document may be reproduced or transmitted in any form or by any means, electronic or mechanical, for any purpose, nor transferred to any other media or language without the written permission of Cognex Corporation.

Copyright © 2017. Cognex Corporation. All Rights Reserved.

Portions of the hardware and software provided by Cognex may be covered by one or more U.S. and foreign patents, as well as pending U.S. and foreign patents listed on the Cognex web site at: <http://www.cognex.com/patents>.

The following are registered trademarks of Cognex Corporation:

Cognex, 2DMAX, Advantage, AlignPlus, Assemblyplus, Check it with Checker, Checker, Cognex Vision for Industry, Cognex VSOC, CVL, DataMan, DisplayInspect, DVT, EasyBuilder, Hotbars, IDMax, In-Sight, Laser Killer, MVS-8000, OmniView, PatFind, PatFlex, PatInspect, PatMax, PatQuick, SensorView, SmartView, SmartAdvisor, SmartLearn, UltraLight, Vision Solutions, VisionPro, VisionView



The following are trademarks of Cognex Corporation:

The Cognex logo, 1DMax, 3D-Locate, 3DMax, BGAll, CheckPoint, Cognex VSoC, CVC-1000, FFD, iLearn, In-Sight (design insignia with cross-hairs), In-Sight 2000, InspectEdge, Inspection Designer, MVS, NotchMax, OCRMax, PatMax RedLine, ProofRead, SmartSync, ProfilePlus, SmartDisplay, SmartSystem, SMD4, VisiFlex, Xpand

Other product and company trademarks identified herein are the trademarks of their respective owners.

Regulations/Conformity

Note: For the most up-to-date CE declaration and regulatory conformity information, please refer to the Cognex online support site: <http://www.cognex.com/Support>.

Safety and Regulatory	
Manufacturer	Cognex Corporation One Vision Drive Natick, MA 01760 USA
	In-Sight 7600/7600C: Regulatory Model 1AAB In-Sight 7800/7800C: Regulatory Model 1AAB In-Sight 7801/7801C: Regulatory Model 1AAB In-Sight 7802/7802C: Regulatory Model 1AAB
FCC	FCC Part 15, Class A This device complies with Part 15 of the FCC Rules. Operation is subject to the following two conditions: (1) this device may not cause harmful interference; and (2) this device must accept any interference received, including interference that may cause undesired operation. This equipment generates, uses, and can radiate radio frequency energy and, if not installed and used in accordance with the instruction manual, may cause harmful interference to radio communications. Operation of this equipment in a residential area is likely to cause harmful interference in which case the user will be required to correct the interference at their own expense.
KCC 	In-Sight 7600/7600C: Regulatory Model 1AAB: MSIP-REM-CGX-1AAB In-Sight 7800/7800C: Regulatory Model 1AAB: MSIP-REM-CGX-1AAB In-Sight 7801/7801C: Regulatory Model 1AAB: MSIP-REM-CGX-1AAB In-Sight 7802/7802C: Regulatory Model 1AAB: MSIP-REM-CGX-1AAB
NRTL	TÜV SÜD AM SCC/NRTL OSHA Scheme for UL/CAN 61010-1.
CB	TÜV SÜD AM, IEC/EN 61010-1. CB report available upon request.
EU RoHS	Compliant to the latest applicable Directive.

China RoHS



Part Name 部件名称	Hazardous Substances 有害物质					
	Lead (Pb) 铅	Mercury (Hg) 汞	Cadmium (Cd) 镉	Hexavalent Chromium (Cr (VI)) 六价铬	Polybrominated biphenyls (PBB) 多溴联苯	Polybrominated diphenyl ethers (PBDE) 多溴二苯醚
Regulatory Model 1AAB	X	O	O	O	O	O

This table is prepared in accordance with the provisions of SJ/T 11364.
这个标签是根据SJ/T 11364 的规定准备的。

O: Indicates that said hazardous substance contained in all of the homogeneous materials for this part is below the limit requirement of GB / T26572 - 2011.
表示本部件所有均质材料中含有的有害物质低于GB / T26572 - 2011 的限量要求。

X: Indicates that said hazardous substance contained in at least one of the homogeneous materials used for this part is above the limit requirement of GB / T26572 - 2011.
表示用于本部件的至少一种均质材料中所含的危害物质超过GB / T26572 - 2011 的限制要求。

X: Indicates that said hazardous substance contained in at least one of the homogeneous materials used for this part is above the limit requirement of GB / T26572 - 2011.
表示用于本部件的至少一种均质材料中所含的危害物质超过GB / T26572 - 2011 的限制要求。

表示用于本部件的至少一种均质材料中所含的危害物质超过GB / T26572 - 2011 的限制要求。

For European Community Users

Cognex complies with Directive 2012/19/EU OF THE EUROPEAN PARLIAMENT AND OF THE COUNCIL of 4 July 2012 on waste electrical and electronic equipment (WEEE).

This product has required the extraction and use of natural resources for its production. It may contain hazardous substances that could impact health and the environment, if not properly disposed.

In order to avoid the dissemination of those substances in our environment and to diminish the pressure on the natural resources, we encourage you to use the appropriate take-back systems for product disposal. Those systems will reuse or recycle most of the materials of the product you are disposing in a sound way.



The crossed out wheeled bin symbol informs you that the product should not be disposed of along with municipal waste and invites you to use the appropriate separate take-back systems for product disposal.

If you need more information on the collection, reuse, and recycling systems, please contact your local or regional waste administration.

You may also contact your supplier for more information on the environmental performance of this product.

Precautions

Observe these precautions when installing the Cognex product, to reduce the risk of injury or equipment damage:

- The vision system is intended to be supplied by a UL or NRTL listed power supply with a 24VDC output rated for at least 2A continuous and a maximum short circuit current rating of less than 8A and a maximum power rating of less than 100VA and marked Class 2 or Limited Power Source (LPS). Any other voltage creates a risk of fire or shock and can damage the components. Applicable national and local wiring standards and rules must be followed.
- To reduce the risk of damage or malfunction due to over-voltage, line noise, electrostatic discharge (ESD), power surges, or other irregularities in the power supply, route all cables and wires away from high-voltage power sources.
- Do not install Cognex products where they are directly exposed to environmental hazards such as excessive heat, dust, moisture, humidity, impact, vibration, corrosive substances, flammable substances, or static electricity.
- Do not expose the image sensor to laser light; image sensors can be damaged by direct, or reflected, laser light. If your application requires the use of laser light that may strike the image sensor, a lens filter at the corresponding laser's wavelength is recommended. Contact your local integrator or application engineer for suggestions.
- Changes or modifications not expressly approved by the party responsible for regulatory compliance could void the user's authority to operate the equipment.
- Service loops should be included with all cable connections.
- Cable shielding can be degraded or cables can be damaged or wear out more quickly if a service loop or bend radius is tighter than 10X the cable diameter. The bend radius must begin at least six inches from the connector.
- This device is a business-use (Class A) EMC-compliant device. The seller and user are advised to be aware of this fact. This device is intended for use in areas outside the home.
- This device should be used in accordance with the instructions in this manual.
- All specifications are for reference purpose only and may be changed without notice.

Table of Contents

Legal Notices	2
Regulations/Conformity	3
China RoHS	4
For European Community Users	4
Precautions	5
Table of Contents	6
Symbols	8
Introduction	9
Support	9
Standard Components	9
Accessories	10
In-Sight Lenses, Lens Covers and Lights	10
DataMan Lenses, Lens Covers and Lights	15
External Lights	17
Cables	18
Mounting Brackets	19
I/O Modules	19
Connectors and Indicators	20
Installation	21
Install the Lens and Lighting	21
Install the C-Mount Lens and Lens Cover Accessory	21
Install the C-Mount Lens and Illumination Accessory	23
Install the Autofocus Accessory and Illumination Accessory	28
Install the In-Sight S-Mount/M12 Manual Focus Lens	33
Mount the Vision System	35
Install the Mounting Bracket (ISB-7000-7K)	36
Install the Mounting Bracket (ISB-7000-5K)	37
Working Distance and Field of View (S-Mount/M12 Lenses)	38
Connect the External Light Cable (Optional)	40
Connect the Ethernet Cable	40
Connect the Breakout Cable	41
Connect the CIO-MICRO I/O Module (Optional)	42
Connect the CIO-1400 I/O Expansion Module (Optional)	45
Replace the SD Card (Optional)	47
Replace the LED Ring Light (Optional)	48
Replace the M12 Autofocus Lens (Optional)	52
Remove the Illumination Accessory PCB	58
Specifications	60
Vision System Specifications	60
Acquisition Trigger	63
General-Purpose Inputs	64
High-Speed Outputs	65
High-Speed Output Wiring	66
External Light Connector	67

Ethernet Cable	68
Breakout Cable	69
I/O Module Cable	70
Vision System Dimensions	71
Vision System Dimensions with Standard Lens Cover (COV-7000-CMNT)	72
Vision System Dimensions with Extended Lens Cover (COV-7000-CMNT-EX)	73
Vision System Dimensions with Illumination and Lens Cover (ISLM-7000-WHI)	74
Mounting Bracket Dimensions (ISB-7000-7K)	75
Mounting Bracket Dimensions (ISB-7000-5K)	76
Vision System C-Mount Lens Clearance Dimensions	77
Cleaning/Maintenance	78
Clean the Vision System Housing	78
Clean the Vision System Image Sensor Window	78

Symbols

The following symbols indicate safety precautions and supplemental information.

 **WARNING:** This symbol indicates the presence of a hazard that could result in death, serious personal injury or electrical shock.

 **CAUTION:** This symbol indicates the presence of a hazard that could result in property damage.

 **Note:** Notes provide supplemental information about a subject.

 **Tip:** Tips provide helpful suggestions and shortcuts that may not otherwise be apparent.

Introduction

The In-Sight[®] vision system is a compact, network-ready, stand-alone machine vision system used for automated inspection, measurement, identification and robot guidance applications on the factory floor. All models can be easily configured remotely over a network using an intuitive user interface.

Support

Many information resources are available to assist you in using the vision system:

- The *In-Sight[®] Explorer Help* and *EasyBuilder Help* files, provided with In-Sight Explorer software.
- On-demand training: <http://www.cognex.com/on-demand-training.aspx>.
- The In-Sight online support site: <http://www.cognex.com/Support/InSight>.

Standard Components

Note:



- Cables are sold separately.
- If any of the standard components appear to be missing or damaged, immediately contact your Cognex Authorized Service Provider (ASP) or Cognex Technical Support.



Component	Description
Vision System	Provides image acquisition, vision processing, job storage, Ethernet connectivity and discrete I/O. The vision system has an 8GB SD card pre-installed.

Accessories

The following components can be purchased separately. For a complete list of options and accessories, contact your local Cognex sales representative.

In-Sight Lenses, Lens Covers and Lights

C-Mount Accessories

Note:

- The following C-Mount lenses are supported with the vision system. If a different lens is used, the following restrictions apply. Refer to [Vision System C-Mount Lens Clearance Dimensions on page 77](#) for more information.



- Maximum thread length is 5.25 mm.
- At infinity focus, the back focal length of the lens cannot be greater than 6.5 mm in length unless the back of the lens is smaller than 14.75 mm diameter.

Standard and Extended C-Mount Lenses and Lens Covers

Note:



- The following C-Mount lenses are supported with the vision system when using the standard lens cover (COV-7000-CMNT) or extended lens cover (COV-7000-CMNT-EX) accessories. If a different lens is used, the following restrictions apply:



- If using the standard lens cover accessory (COV-7000-CMNT), the maximum lens length is 41mm with a bandpass filter, the maximum lens body diameter is 36.5mm and the maximum diameter including locking screws is 47mm.
- If using the extended lens cover accessory (COV-7000-CMNT-EX), the maximum lens length is 62mm with a bandpass filter, the maximum lens body diameter is 36.5mm and the maximum diameter including locking screws is 46.5mm.





CAUTION: If installing a standard or extended C-Mount lens, the illumination accessory (ISLM-7000-WHI) PCB should not be installed to the vision system. Refer to [Remove the Illumination Accessory PCB on page 58](#) for steps to safely remove the PCB and avoid damage to the vision system.

16mm F11 fixed aperture lens (LEC-CFF16-F11)	
16mm F16 fixed aperture lens (LEC-CFF16-F16)	
25mm F11 fixed aperture lens (LEC-CFF25-F11)	
25mm F16 fixed aperture lens (LEC-CFF25-F16)	
35mm F11 fixed aperture lens (LEC-CFF35-F11)	
35mm F16 fixed aperture lens (LEC-CFF35-F16)	
50mm F2-F22 aperture lens (LEC-59873)	
Note: The extended lens cover accessory (COV-7000-CMNT-EX) is required for the 50mm lens.	



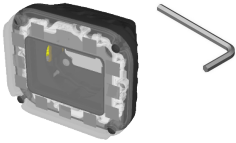
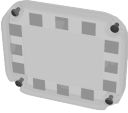

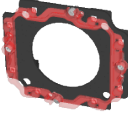
9mm F1.4 aperture lens (LFC-9F1B)	
12.5mm F1.4 aperture lens (LFC-12.5F)	
16mm F1.4 aperture lens (LFC-16F1)	
25mm F1.4 aperture lens (LFC-25F1)	
35mm F1.6 aperture lens (LFC-35F1)	
50mm F1.4 aperture lens (LFC-50F1)	
Note: The extended lens cover accessory (COV-7000-CMNT-EX) is required for the 50mm lens.	
Standard lens cover and lens cover adapter (COV-7000-CMNT)	
Extended lens cover and lens cover adapter (COV-7000-CMNT-EX)	

Illumination Accessory C-Mount Lenses, Lens Covers and Lights

CAUTION: The following C-Mount lenses are supported with the illumination accessory (ISLM-7000-WHI). If using a different C-Mount lens with the illumination accessory, it must be 29.5mm in diameter or smaller. Maximum lens length is 38.5mm without a bandpass filter and 36mm with a bandpass filter. Larger lenses will irretrievably damage the vision system.

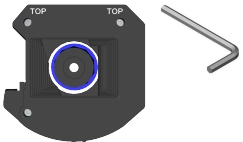
9mm F1.4 aperture lens (LFC-9F1B)	
12.5mm F1.4 aperture lens (LFC-12.5F)	
16mm F1.4 aperture lens (LFC-16F1)	
25mm F1.4 aperture lens (LFC-25F1)	
35mm F1.6 aperture lens (LFC-35F1)	
50mm F1.4 aperture lens (LFC-50F1)	
Illumination with white LED ring light, lens cover and hex wrench (ISLM-7000-WHI)	
Clear illumination lens cover (COV-7000-CLR)	
Polarized lens cover (COV-7000-PL-FULL)	
Note: When installing the lens cover, pull the red tab to remove the protective film.	
Red LED ring light (ISL-7000-RD)	
IR LED ring light (ISL-7000-IR)	
Blue LED ring light (ISL-7000-BL)	
White LED ring light (ISL-7000-WHI)	
Red bandpass filter (ISF-7000-RDBP605) used with the corresponding red LED ring light (ISL-7000-RD)	
IR bandpass filter (ISF-7000-IRBP815) used with the corresponding IR LED ring light (ISL-7000-IR)	
Blue bandpass filter (ISF-7000-BLBP435) used with the corresponding blue LED ring light (ISL-7000-BL)	

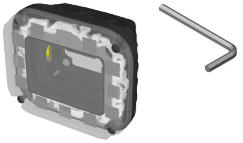
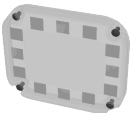
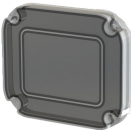
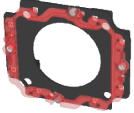
S-Mount/M12 Autofocus Accessories

Autofocus module with 8mm lens (ISAF-7000-8mm)	
Lens removal tool with replacement lens nuts (ISAF-7000-TOOL)	
6mm M12 lens (LM12-06-01)	
8mm M12 lens (LM12-08-01-F2.2)	
12mm M12 lens (LM12-12-01-F2.3)	
16mm M12 lens (LM12-16-01)	
25mm M12 lens (LM12-25-01)	
Illumination with white LED ring light, lens cover and hex wrench (ISLM-7000-WHI)	
Clear illumination lens cover (COV-7000-CLR)	
Polarized lens cover (COV-7000-PL-FULL)	
Note: When installing the lens cover, pull the red tab to remove the protective film.	
Red LED ring light (ISL-7000-RD)	
IR LED ring light (ISL-7000-IR)	
Blue LED ring light (ISL-7000-BL)	
White LED ring light (ISL-7000-WHI)	
Red bandpass filter (ISF-7000-RDBP605) used with the corresponding red LED ring light (ISL-7000-RD)	
IR bandpass filter (ISF-7000-IRBP815) used with the corresponding IR LED ring light (ISL-7000-IR)	
Blue bandpass filter (ISF-7000-BLBP435) used with the corresponding blue LED ring light (ISL-7000-BL)	

S-Mount/M12 Manual Focus Accessories

Note:

- The DataMan clear lens cover accessory (DM300-CLCOV) is supported with In-Sight S-Mount/M12 manual focus lenses and provides IP65 rating. For more information, refer to [DataMan Lenses, Lens Covers and Lights on page 15](#).



- The following S-Mount/M12 lenses are supported with the vision system. If a different lens is used, the following restrictions apply:
 - At infinity focus, the back focal length must be greater than 5.5mm.
 - Close up, the back focal length of the lens cannot be greater than 13mm.

6mm M12 lens (LM12-06-01)	
8mm M12 lens (LM12-08-01-F2.2)	
12mm M12 lens (LM12-12-01-F2.3)	
16mm M12 lens (LM12-16-01)	
25mm M12 lens (LM12-25-01)	
S-Mount/M12 adapter, lens locking cone and installation tool (ISLN-7000-SMNT)	
Note: The S-Mount accessory kit (ISLN-7000-SMNT) is required when installing In-Sight S-Mount/M12 manual focus lenses.	





DataMan Lenses, Lens Covers and Lights

The following DataMan accessories are also supported with the In-Sight vision system for S-Mount/M12 manual focus lens configurations. DataMan lenses are only supported with DataMan lens covers and lights.

Note:

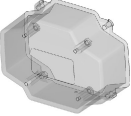
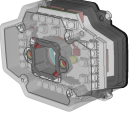
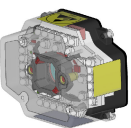

- The following S-Mount/M12 lenses are supported with the vision system. If a different lens is used, the following restrictions apply:
 - At infinity focus, the back focal length must be greater than 5.5 mm.
 - Close up, the back focal length of the lens cannot be greater than 10 mm.

10.3 mm M12 lens with locking (DM300-LENS-10) and 10.3 mm IR M12 lens with locking (DM300-LENS-10-IR)	
16 mm M12 lens with locking (DM300-LENS-16)	
25 mm M12 lens with lens spacer and hex wrench (DM300-LENS-25) (also requires Extension kit)	
Extension kit (DM300-EXT)	
Clear lens cover (DM300-CLCOV)	
Clear lens cover with white LED illumination (DM300-CLCOV-WHI)	
Diffuse lens cover with red LED illumination (DM300-DLCOV-RE)	
Diffuse lens cover with blue LED illumination (DM300-DLCOV-BL)	
Diffuse lens cover with IR LED illumination (DM300-DLCOV-IR)	
Polarized lens cover with red LED illumination (DM300-PLCOV-RE)	
Diffuse lens cover, red illumination (assembled), ESD safe (DM300-DLCOV-RE-ESD)	

Polarized red LED high-powered integrated light, ESD safe (DM360-HPIL-RE-P)	
Non-polarized red LED high-powered integrated light (DM360-HPIL-RE)	

High Power Illuminations

Red narrow (DM30X-HPIA3-625)	
Red wide (DM30X-HPIA3-625-W)	
White narrow (DM30X-HPIA3-WHI)	
White wide (DM30X-HPIA3-WHI-W)	
Blue narrow (DM30X-HPIA3-470)	
Blue wide (DM30X-HPIA3-470-W)	
Infrared narrow (DM30X-HPIA3-IR)	
Infrared wide (DM30X-HPIA3-IR-W)	

Note:

- If using the following Cognex high-power lights with a DM30X-HPIA-xxx product ID:









- A spacer kit accessory (DMA-SPKIT-30X-00) is required when using the high power illumination accessory. When the spacer is used, the field of view will be limited for wide-angled lenses.
- A Fair-Rite ferrite (part number 0431167281) must be attached to the External Light cable to reduce emissions.

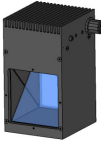

Red narrow (DM30X-HPIA-625)	
Red wide (DM30X-HPIA-625-W)	
Red narrow with polarizer (DM30X-HPIA-625P)	
White narrow (DM30X-HPIA-WHI)	
White wide (DM30X-HPIA-WHI-W)	
Blue narrow (DM30X-HPIA-470)	
Blue wide (DM30X-HPIA-470-W)	
Infrared narrow (DM30X-HPIA-IR)	
Infrared wide (DM30X-HPIA-IR-W)	

External Lights





Note:

- External lights can be connected to the vision system's LIGHT connector using the External Light cable. The vision system supports using either an external light or the illumination accessory (ISLM-7000-WHI), but does not support using both lighting devices simultaneously.
- If using a Cognex IVSL-ODDM-S75, IVSL-YLW2X-xxx, IVSL-YLW300-xxx or IVSL-LX520-xxx external light, a Fair-Rite ferrite (part number 0431167281) must be attached to the External Light cable to reduce emissions.
- If daisy-chaining multiple Cognex IVSL-YLW2X-xxx or IVSL-YLW300-xxx external lights, the lights must be powered externally by a separate power supply. A Cognex control cable (CCB-FOV25-MAL-012) can be used to connect the vision system's LIGHT connector to the external light and a Cognex power cable (IVSL-5PM12-5) can be used to connect the light to the separate power supply. Only the power and ground wires from the Cognex power cable (IVSL-5PM12-5) should be connected to the remote power supply.
- If using a Cognex IVSL-LX520-xxx external light, the lights must be powered externally by a separate power supply. A Cognex control cable (CCB-FOV25-MAL-012) can be used to connect the vision system's LIGHT connector to the external light and a Cognex power cable (IVSL-5PM12-5) can be used to connect the light to the separate power supply. Only the power and ground wires from the Cognex power cable (IVSL-5PM12-5) should be connected to the remote power supply. The following power cables must not be used with IVSL-LX520-xxx external lights: IVSL-5PM12-J300, IVSL-5PM12-J500 and IVS-5PM12-J1000, IVSL-5PM12-J2000.

Ring light (CLRR-R7030G1CLR)	
Back light (CLRB-F100100G1)	
Coaxial Dual on Access Light (DOAL) (CLRO-K5050G1)	
Spot light (CLRS-P14G1)	
Dark-field light (CLRD-D120G1)	
Brick light, narrow blue (IVSL-ODDM-S75-470)	
Brick light, narrow red (IVSL-ODDM-S75-625)	
Brick light, narrow white (IVSL-ODDM-S75-WHI)	

Bar light, wide red (IVSL-YLW2X-625)	
Bar light, narrow red, linear polarizer (IVSL-YLW2X-625P)	
Bar light, narrow infrared (IVSL-YLW2X-850)	
Bar light, narrow blue (IVSL-YLW300-470)	
Bar light, wide blue (IVSL-YLW300-470 W)	
Bar light, narrow red (IVSL-YLW300-625)	
Bar light, wide red (IVSL-YLW300-625 W)	
Bar light, narrow white (IVSL-YLW300-WHI)	
Bar light, wide white (IVSL-YLW300-WHI W)	
Bar light, blue (IVSL-LX520-470)	
Bar light, red (IVSL-LX520-625)	
Bar light, linear polarizer (IVSL-LX520-LP)	



Cables

Breakout cable, M12-12, 5m (CCBL-05-01)	
Breakout cable, M12-12 (CCBPWRIO- xx) (straight, xx specifies length: 5m, 10m, 15m)	
Breakout cable, M12-12 (CCB-PWRIO-xxR) (angled, xx specifies length: 5m, 10m, 15m)	
Ethernet M12 to RJ-45 cable (CCB-84901-2001-xx) (xx specifies length: 2m, 5m, 10m, 15m, 30m)	
External Light cable (CCB-M12LTF-xx) (xx specifies length: 0.5m, 1m, 2m, 5m)	
External Light cable (IVSL-5PM12-J300, IVSL-5PM12-J500, IVSL-5PM12-J1000 and IVSL-5PM12-J2000)	
I/O Module cable M12-12 to DB15 (CCB-PWRIO-MOD-xx) (xx specifies length: 2m, 5m)	

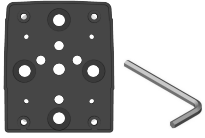
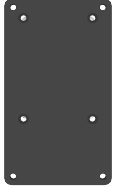
Mounting Brackets

<p>Mounting bracket with M3x4 socket head screws and hex wrench (ISB-7000-7K). Also has 1/4 - 20, M6 and flathead mounting holes. Mounting holes compatible with the In-Sight 7000 series vision system.</p>	
<p>Mounting bracket with Phillips flat head M3 screws and M4x4 screws (ISB-7000-5K). Mounting holes compatible with the In-Sight 5000 series vision system.</p>	

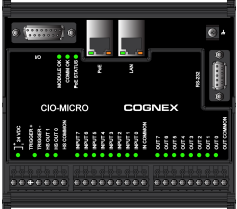
I/O Modules

<p>In-Sight CIO-MICRO I/O Module (CIO-MICRO-00)</p>	
<p>In-Sight 1400 I/O Expansion Module (CIO-1400)</p>	

Connectors and Indicators

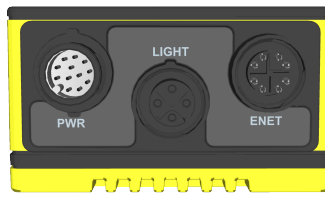

Connector	Function
PWR Connector	Connects the Breakout cable, which provides connections to an external power supply, the acquisition trigger input, general-purpose inputs, high-speed outputs, and RS-232 serial communications. For more information, refer to Breakout Cable on page 69 . Alternately, this connector is used to attach the I/O Module cable to a compatible In-Sight I/O module, which adds general-purpose discrete I/O. For more information, refer to I/O Module Cable on page 70 .
LIGHT Connector	Connects the vision system to an external lighting device. For more information, refer to External Light Cable on page 1 .
ENET Connector	Connects the Ethernet cable, which provides 10/100/1000 Ethernet connectivity. For more information, refer to Ethernet Cable on page 68 .



Indicator	Function
	Focus Metric LEDs Indicates the image focus score (0 - 10) while in Live Video Mode within In-Sight Explorer.
	TRIG Button Manually triggers an image acquisition when the vision system is either: <ul style="list-style-type: none"> Online within In-Sight Explorer and the acquisition Trigger parameter is set to Manual. Offline within In-Sight Explorer.
	Power LED The green LED illuminates to indicate that the vision system is powered on.
	SD Card Status LED <ul style="list-style-type: none"> Off: SD card is not inserted. Green: SD card is present and it is safe to remove the SD card after removing power from the vision system. Yellow: The SD card is present, but it is not safe to remove it.
	Pass/Fail LED and Indicator Ring Green or red when active. User configurable.
	Network LED The yellow LED flashes to indicate network activity.
	Error LED Red when active. User configurable.
	TUNE Button Used as an Event Trigger within In-Sight Explorer to force a cell containing an Event structure to run when the TUNE button is pressed.

Installation

This section describes the connection of the vision system to its standard components and accessories. For a complete list of options and accessories, contact your Cognex sales representative.

 **Note:** Cables are sold separately.

 **CAUTION:** All cable connectors are “keyed” to fit the connectors on the vision system; do not force the connections or damage may occur.

Install the Lens and Lighting

You can choose between a variety of different C-Mount and S-Mount/M12 lenses and lens covers to install to the vision system. Refer to [In-Sight Lenses, Lens Covers and Lights on page 10](#) and [DataMan Lenses, Lens Covers and Lights on page 15](#) for a complete list of options and accessories.

Install the C-Mount Lens and Lens Cover Accessory

Complete the following steps to install a standard or extended C-Mount lens with the standard lens cover (COV-7000-CMNT) or extended lens cover (COV-7000-CMNT-EX) accessories. For a list of supported accessories, refer to [Standard and Extended C-Mount Lenses and Lens Covers on page 10](#).

 **CAUTION:** If installing a standard or extended C-Mount lens, the illumination accessory (ISLM-7000-WHI) PCB should not be installed to the vision system. Refer to [Remove the Illumination Accessory PCB on page 58](#) for steps to safely remove the PCB and avoid damage to the vision system.

1. Remove the rubber faceplate covering the image sensor window, if present.
2. Remove the protective film covering the threaded lens opening, if present.
3. Place the lens cover adapter on the faceplate of the vision system. Insert the four adapter screws and tighten; the maximum torque is 0.26 Nm (37.5 in-oz).
4. Thread the lens into the vision system.

5. Attach the standard lens cover (COV-7000-CMNT) or extended lens cover (COV-7000-CMNT-EX) to the vision system. Rotate the lens cover clockwise approximately seven degrees to lock it.

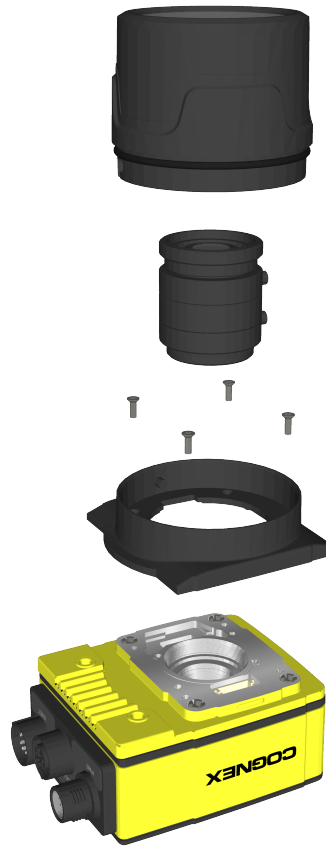

Install the C-Mount Lens and Illumination Accessory

Complete the following steps to install a C-Mount lens and the illumination accessory (ISLM-7000-WHI).

CAUTION:

- Refer to [Illumination Accessory C-Mount Lenses, Lens Covers and Lights on page 12](#) for lenses supported with the illumination accessory (ISLM-7000-WHI). If using a different C-Mount lens with the illumination accessory, it must be 29.5mm in diameter or smaller. Maximum lens length is 38.5mm without a bandpass filter and 36mm with a bandpass filter. Larger lenses will irretrievably damage the vision system.
- Do not hot-plug the illumination accessory; verify the vision system is not receiving power when connecting or disconnecting the illumination accessory. Failure to remove power during this procedure may result in damage to the vision system and/or the illumination accessory.
- The vision system should be grounded, either by mounting the vision system to a fixture that is electrically grounded or by attaching a wire from the vision system's mounting fixture to frame ground or Earth ground. If a ground wire is used, it should be attached to one of the four mounting points on the back plate of the vision system; not to the mounting points on the front of the vision system.
- Tighten all of the illumination accessory screws in the following sequence.

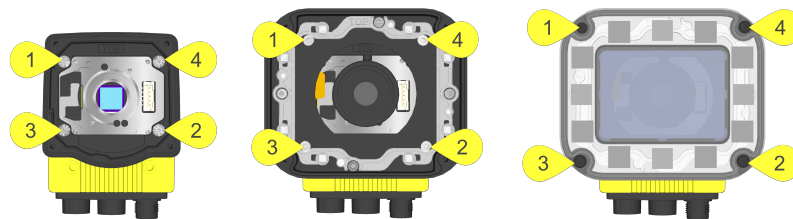

1. Remove the rubber faceplate covering the image sensor window, if present.
2. Remove the protective film covering the threaded lens opening, if present.
3. Plug the PCB into the lighting connector on the vision system faceplate.

CAUTION: If uninstalling the PCB from the vision system, refer to [Remove the Illumination Accessory PCB on page 58](#) for steps to safely remove the PCB and avoid damage to the vision system.

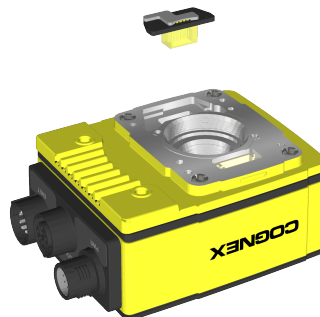

- Place the spacer on top of the vision system with “TOP” oriented upward. Verify seating of the gasket on the bottom of the spacer. Insert the four M3 x 6mm screws and use a 2mm hex wrench to torque screws to 0.34 Nm (3 in-lb).

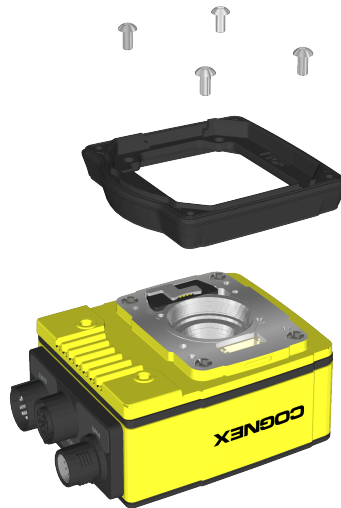

- Thread the lens into the vision system. Focusing of the C-Mount lens prior to light housing installation is required.

Note: If installing the autofocus accessory (ISAF-7000-8mm), refer to [Install the Autofocus Accessory and Illumination Accessory on page 28](#).

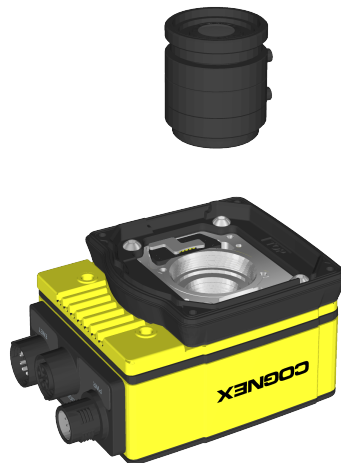

6. Place the light housing with LED ring light on top of the spacer, with “TOP” oriented upward. Verify seating of the gasket on the top of the spacer. There are four captive screw access holes near the white circles on the LED ring light. Use a 2mm hex wrench to torque captive screws to 0.34 Nm (3 in-lb). If a different LED color is required, refer to [Replace the LED Ring Light \(Optional\) on page 48](#).

CAUTION:

- Do not hot-plug the LED ring light; verify the vision system is not receiving power when connecting or disconnecting the LED ring light.
 - A connector protrudes from the underside of the light housing. To prevent damage, it is recommended the light housing not be removed from the box until ready to be assembled.
-



7. If using a bandpass filter, insert the filter in the light baffle so that it's held in place between the light baffle's filter retention tabs.

 **Tip:** Wear gloves when installing the filter to prevent getting fingerprints on the surface of the filter.

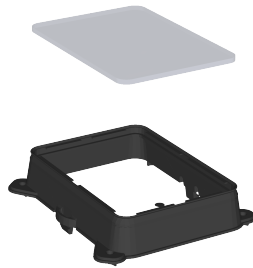

Push the filter down and snap it into place. Ensure the filter retention tabs are flush with the top surface of the filter.

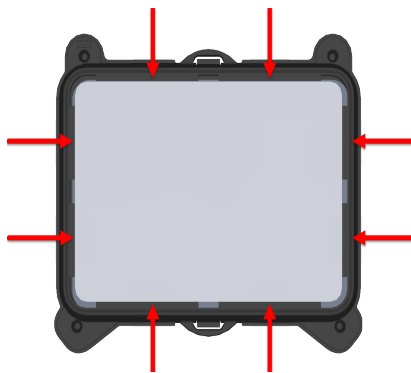

8. The light baffle is keyed to fit the LED ring light structure and snaps into place with the keyed tabs sitting flush over each light housing captive screw access hole. Tilt the light baffle toward the light housing and maneuver the light baffle past the top of the LED ring light structure. Compress the light baffle and maneuver the bottom of the light baffle past the bottom of the LED ring light structure until the light baffle snaps into place.

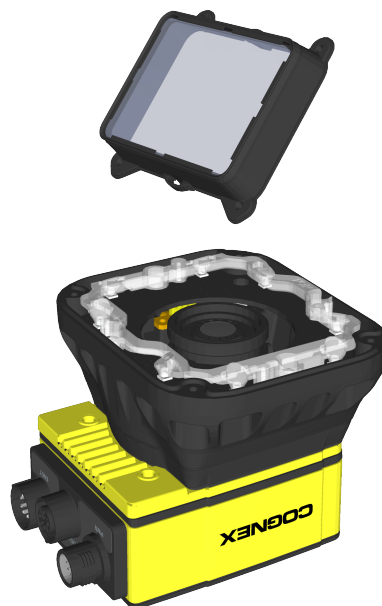

9. Place the light cover on the light housing. Align the central clear region of the light cover with the light baffle edges. Insert the four M3 x 12mm screws and use a 2mm hex wrench to torque screws to 0.31 Nm (2.75 in-lb).

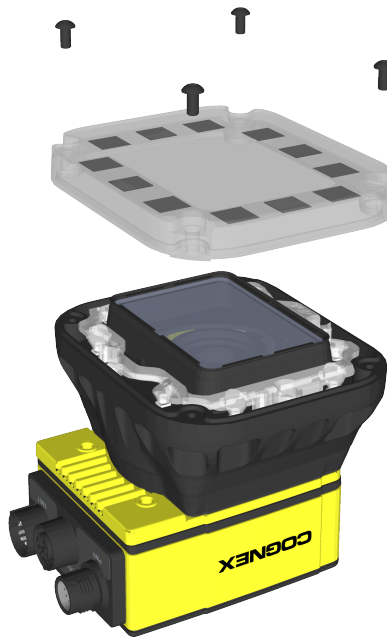

Install the Autofocus Accessory and Illumination Accessory

Complete the following steps to install the autofocus accessory (ISAF-7000-8mm). For a list of supported accessories, refer to [S-Mount/M12 Autofocus Accessories on page 13](#).

Note:



- The autofocus accessory has an 8mm M12 lens pre-installed. If a different lens is required, it should be installed into the autofocus module before the autofocus module is installed to the vision system. Refer to [Replace the M12 Autofocus Lens \(Optional\) on page 52](#) for more information.
- The illumination accessory (ISLM-7000-WHI) is sold separately. It is the only lens cover available for the autofocus module and is required for IP67 rating.

CAUTION:

- When installing the illumination accessory (ISLM-7000-WHI):
 - Do not hot-plug the illumination accessory; verify the vision system is not receiving power when connecting or disconnecting the illumination accessory. Failure to remove power during this procedure may result in damage to the vision system and/or the illumination accessory.
 - The vision system should be grounded, either by mounting the vision system to a fixture that is electrically grounded or by attaching a wire from the vision system's mounting fixture to frame ground or Earth ground. If a ground wire is used, it should be attached to one of the four mounting points on the back plate of the vision system; not to the mounting points on the front of the vision system.
- Tighten all of the illumination accessory screws in the following sequence.

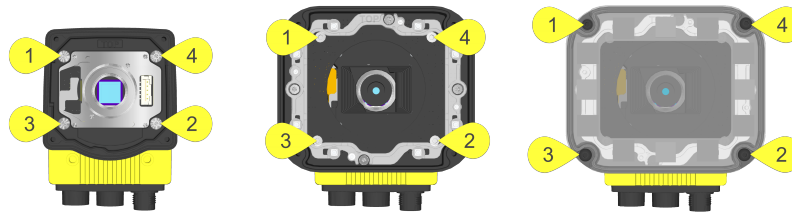

- Remove the rubber faceplate covering the image sensor window, if present.
- Remove the protective film covering the threaded lens opening, if present.
- Plug the PCB into the lighting connector on the vision system faceplate.

CAUTION: If uninstalling the PCB from the vision system, refer to [Remove the Illumination Accessory PCB on page 58](#) for steps to safely remove the PCB and avoid damage to the vision system.

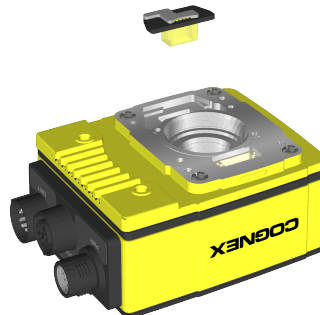

4. Place the spacer on top of the vision system with “TOP” oriented upward. Verify seating of the gasket on the bottom of the spacer. Insert the four M3 x 6mm screws and use a 2mm hex wrench to torque screws to 0.34 Nm (3 in-lb).

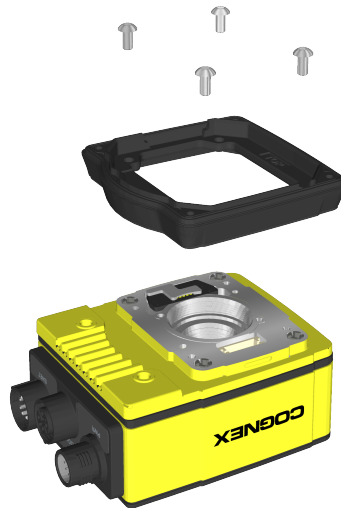

5. An 8mm M12 lens is pre-installed in the autofocus module accessory and held in place with a blue threaded lens nut on the underside of the autofocus module. There are two alignment pins on the base of the autofocus module; seat the pins into the vision system faceplate. There are three captive screws in the autofocus module; partially thread the screws into the vision system faceplate using a 1.5mm hex wrench. Once threaded, torque screws to 0.5 Nm (4.43 in-lb) using a torque screwdriver with a 1.5mm hex torque bit capable of reaching 15mm into a 2.5mm diameter hole (for example, Wiha Tools 1.5mm Hex Metric Torque Blade [SKU 28545] used with the Adjustable Torque Handle [SKU 28550]).

CAUTION: Do not hot-plug the autofocus module; verify the vision system is not receiving power when connecting or disconnecting the autofocus module.

Note: If a different lens is required, it should be installed in the autofocus module before the autofocus module is installed to the vision system. Refer to [Replace the M12 Autofocus Lens \(Optional\) on page 52](#) for more information.



- Place the light housing with LED ring light on top of the spacer, with "TOP" oriented upward. Verify seating of the gasket on the top of the spacer. There are four captive screw access holes near the white circles on the LED ring light. Use a 2mm hex wrench to torque captive screws to 0.34 Nm (3 in-lb).

CAUTION:

- Do not hot-plug the LED ring light; verify the vision system is not receiving power when connecting or disconnecting the LED ring light.
 - A connector protrudes from the underside of the light housing. To prevent damage, it is recommended the light housing not be removed from the box until ready to be assembled.
-



7. If using a bandpass filter, insert the filter in the light baffle so that it's held in place between the light baffle's filter retention tabs.



Tip: Wear gloves when installing the filter to prevent getting fingerprints on the surface of the filter.

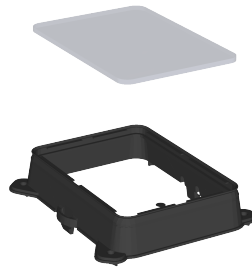

Push the filter down and snap it into place. Ensure the filter retention tabs are flush with the top surface of the filter.

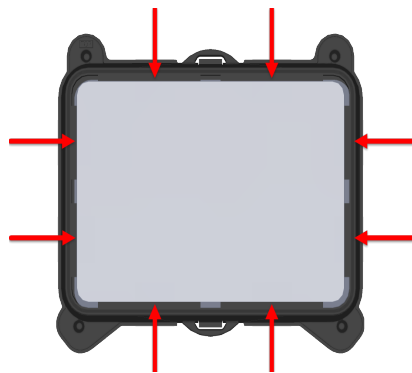

8. The light baffle is keyed to fit the LED ring light structure and snaps into place with the keyed tabs sitting flush over each light housing captive screw access hole. Tilt the light baffle toward the light housing and maneuver the light baffle past the top of the LED ring light structure. Compress the light baffle and maneuver the bottom of the light baffle past the bottom of the LED ring light structure until the light baffle snaps into place.

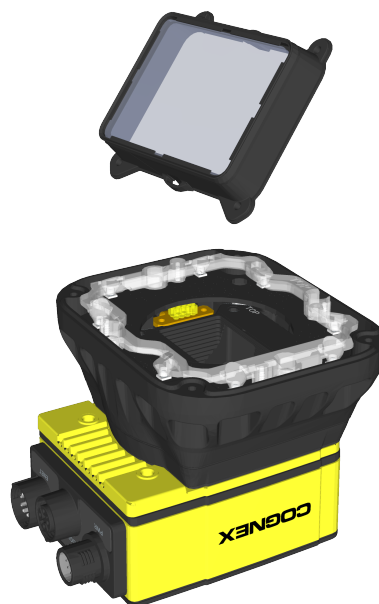

9. Place the light cover on the light housing. Align the central clear region of the light cover with the light baffle edges. Insert the four M3 x 12mm screws and use a 2mm hex wrench to torque screws to 0.31 Nm (2.75 in-lb).

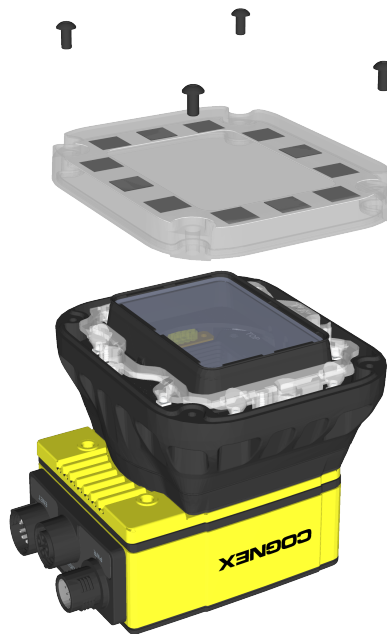

Install the In-Sight S-Mount/M12 Manual Focus Lens

Complete the following steps to install an In-Sight S-Mount/M12 manual focus lens. For a list of supported accessories, refer to [S-Mount/M12 Manual Focus Accessories on page 14](#).

Note:

- The S-Mount accessory kit (ISLN-7000-SMNT) is required when installing In-Sight S-Mount/M12 manual focus lenses.
- The DataMan clear lens cover accessory (DM300-CLCOV) is supported with In-Sight S-Mount/M12 manual focus lenses and provides IP65 rating. For more information, refer to [DataMan Lenses, Lens Covers and Lights on page 15](#).

1. Remove the rubber faceplate covering the image sensor window, if present.
2. Remove the protective film covering the threaded lens opening, if present.
3. Place the S-Mount adapter over the image sensor window.

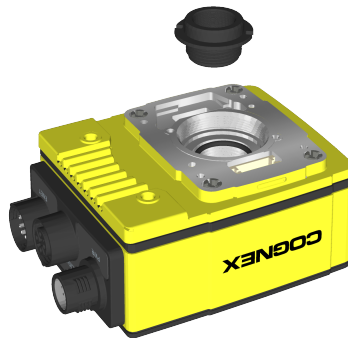

4. Place the "In-Sight" end of the adapter tool on the adapter. Turn clockwise until tight.

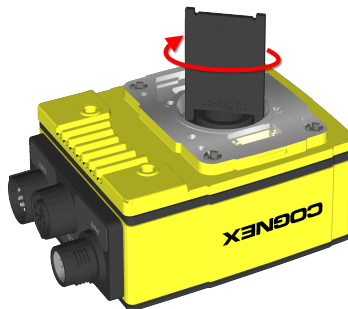

5. Remove the adapter tool. Thread the lens into the vision system. Focusing of lens prior to installation of the rubber lens-locking cone is required.

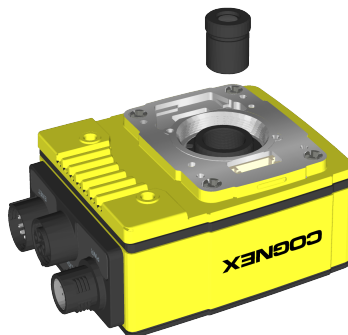

6. Place the rubber lens-locking cone over the M12 lens until it snaps into place around the nose of the lens. When installing, avoid rotating the M12 lens.

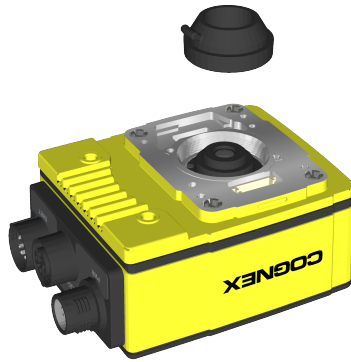

7. If using a lens cover accessory, attach the lens cover to the vision system.

Mount the Vision System

The vision system provides mounting holes for attachment to a mounting surface.

CAUTION: The vision system should be grounded, either by mounting the vision system to a fixture that is electrically grounded or by attaching a wire from the vision system's mounting fixture to frame ground or Earth ground. If a ground wire is used, it should be attached to one of the four mounting points on the back plate of the vision system; not to the mounting points on the front of the vision system.

1. Align the holes on the mounting surface with the mounting holes on the vision system.
2. Insert the M3 screws into the mounting holes and tighten using a 2.5mm hex wrench; the maximum torque is 0.90 Nm (8 in-lb).

Note: The maximum insertion depth of the M3 screws is 3.5mm in the rear housing and 3.75mm in the front housing, plus the thickness of the mounting material used.



Install the Mounting Bracket (ISB-7000-7K)

The accessory mounting bracket kit (ISB-7000-7K) includes the mounting bracket, M3 screws (quantity 4) and a hex wrench for attaching the vision system to the mounting bracket. The mounting bracket also has 1/4 - 20, M6 and flathead mounting holes for mounting the vision system to a mounting surface. Refer to [Mounting Bracket Dimensions \(ISB-7000-7K\) on page 75](#) for more information.

CAUTION:

- The vision system should be grounded, either by mounting the vision system to a fixture that is electrically grounded or by attaching a wire from the vision system's mounting fixture to frame ground or Earth ground. If a ground wire is used, it should be attached to one of the four mounting points on the back plate of the vision system; not to the mounting points on the front of the vision system.
- When mounting the vision system to the mounting bracket, use the M3 screws supplied with the mounting kit. If using the 1/4 - 20 or M6 screw holes on the mounting bracket to secure the vision system to a mounting surface, the insertion depth of the screw should not exceed 7mm. Allowing the mounting screws to bottom in the mounting hole can damage the vision system.

1. Align the mounting bracket with the mounting holes on the vision system.
2. Insert the M3 screws into the mounting holes and tighten using a 2.5mm hex wrench; the maximum torque is 0.90 Nm (8 in-lb).



Install the Mounting Bracket (ISB-7000-5K)

The accessory mounting bracket kit (ISB-7000-5K) includes the mounting bracket, Phillips flat head M3 screws (quantity four) for attaching the vision system to the mounting bracket and M4 screws (quantity 4) for securing the bracket to a mounting surface. Refer to [Mounting Bracket Dimensions \(ISB-7000-5K\) on page 76](#) for more information.

CAUTION:

- The vision system should be grounded, either by mounting the vision system to a fixture that is electrically grounded or by attaching a wire from the vision system's mounting fixture to frame ground or Earth ground. If a ground wire is used, it should be attached to one of the four mounting points on the back plate of the vision system; not to the mounting points on the front of the vision system.
- When mounting the vision system to the mounting bracket, use the Phillips head screws supplied with the mounting kit. If using the M4 screw holes on the mounting bracket to secure the vision system to a mounting surface, the insertion depth of the screw should not exceed 4mm. Allowing the mounting screws to bottom in the mounting hole can damage the vision system.

1. Align the mounting bracket with the mounting holes on the vision system.
2. Insert the Phillips flat head screws into the mounting holes and tighten; the maximum torque is 0.56 Nm (5 in-lb).



Working Distance and Field of View (S-Mount/M12 Lenses)

The working distance is the distance from the vision system lens to the part that needs to be inspected; field of view is what the vision system can see at that distance. As the working distance increases, so does the size of the field of view.

Note: The following charts show the design field of view of the In-Sight S-Mount/M12 accessory lenses and is fully mapped onto the image sensor. Additional field beyond the design field of view may have vignetting. For supported In-Sight lenses, refer to [S-Mount/M12 Autofocus Accessories on page 13](#) and [S-Mount/M12 Manual Focus Accessories on page 14](#).

Horizontal Field of View (640x480)

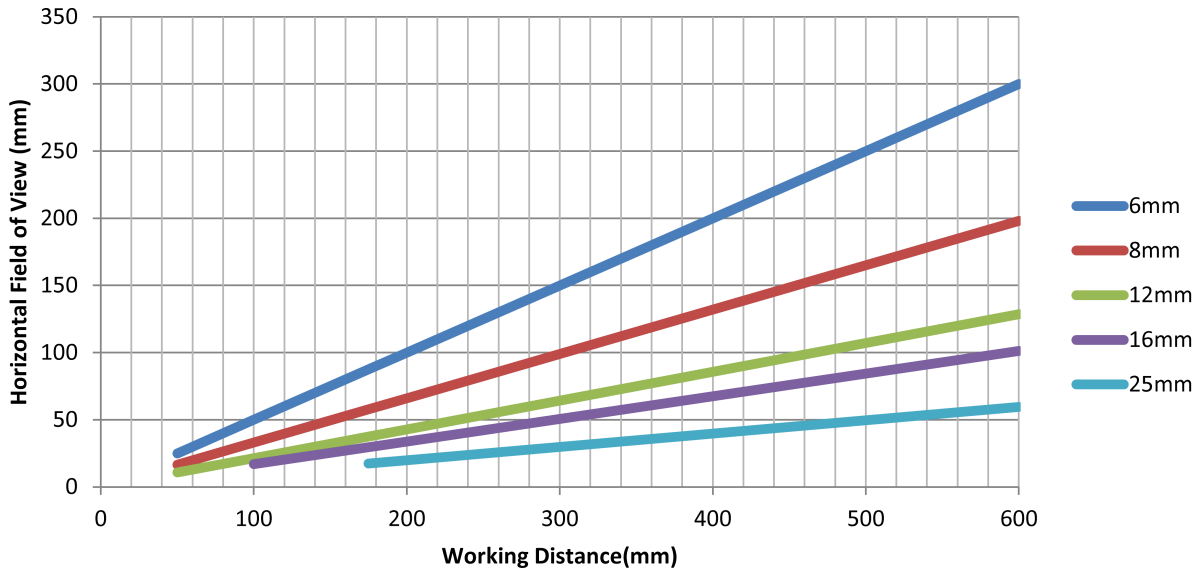

Horizontal Field of View (800x600)

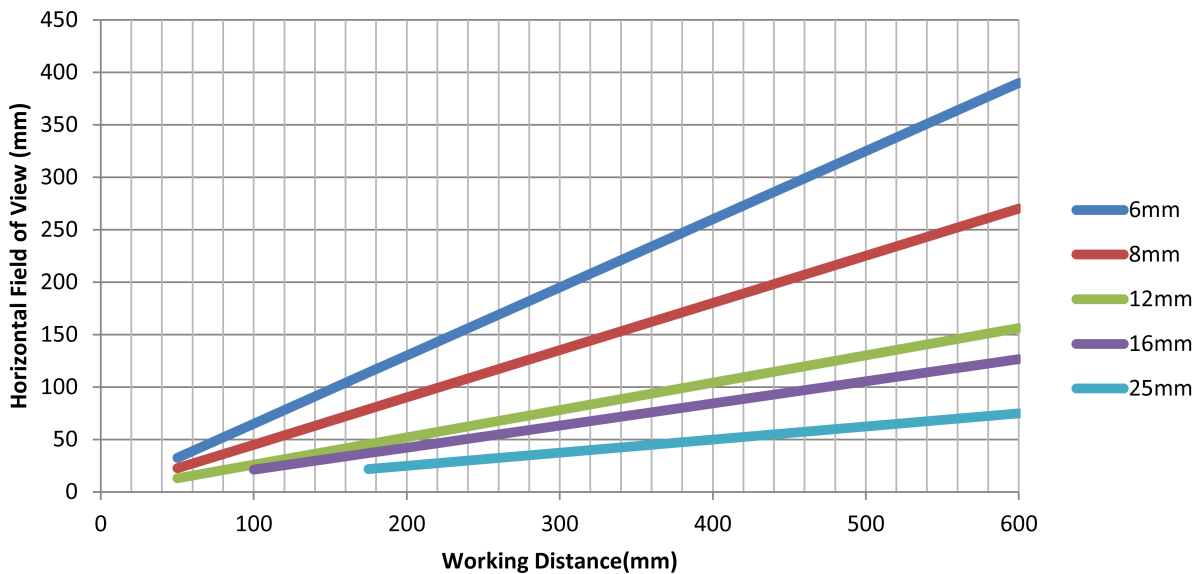

Horizontal Field of View (1280x1024)

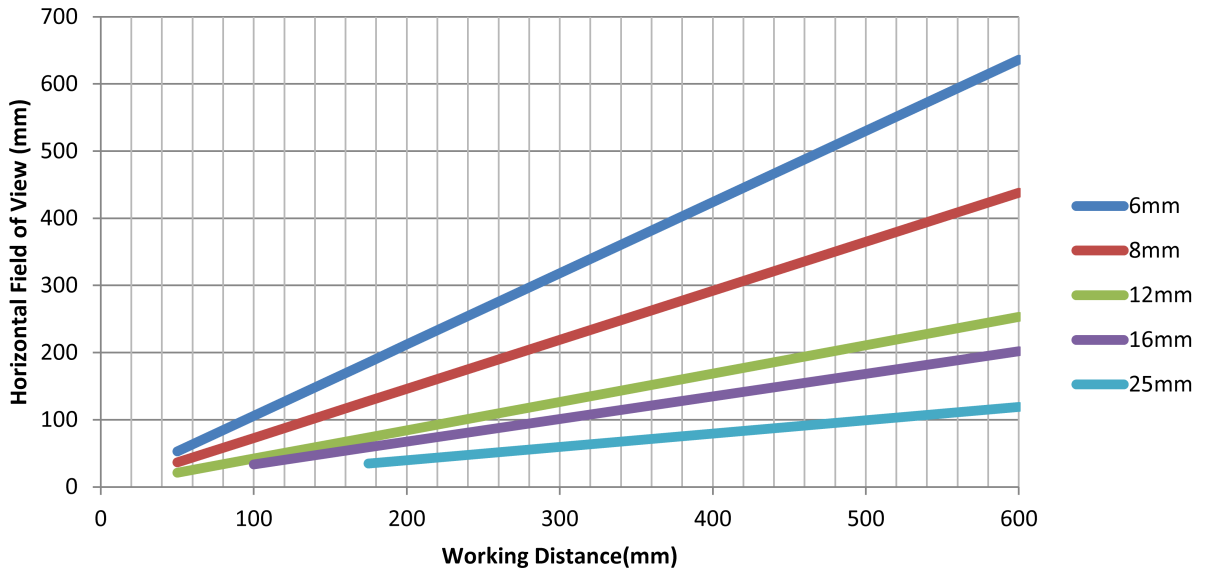

Horizontal Field of View (1600x1200)

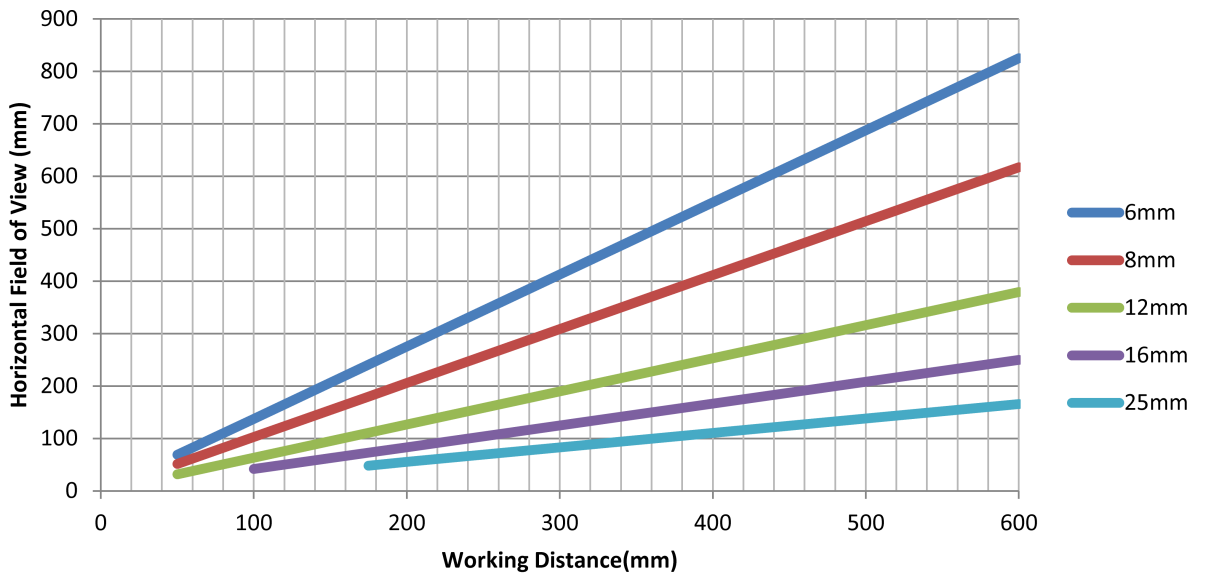

Connect the External Light Cable (Optional)

1. Remove the protective cap from the LIGHT connector, if present.
2. Connect the External Light cable's M12 connector to the vision system's LIGHT connector.
3. Connect the other end of the Light cable to an external lighting device (for example, a strobe light).

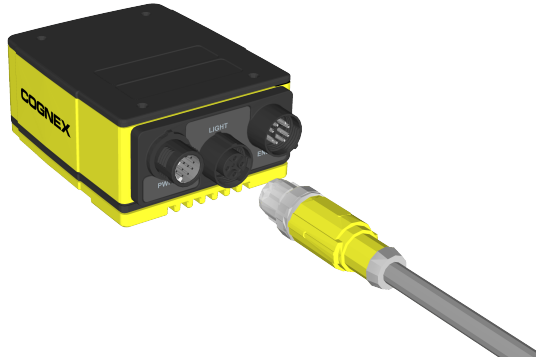

Connect the Ethernet Cable

CAUTION: The Ethernet cable shield must be grounded at the far end. Whatever this cable is plugged into (usually a switch or router) should have a grounded Ethernet connector. A digital voltmeter should be used to validate the grounding. If the far end device is not grounded, a ground wire should be added in compliance with local electrical codes.

1. Connect the Ethernet cable's M12 connector to the vision system's ENET connector.
2. Connect the Ethernet cable's RJ-45 connector to a switch/router or PC, as applicable.

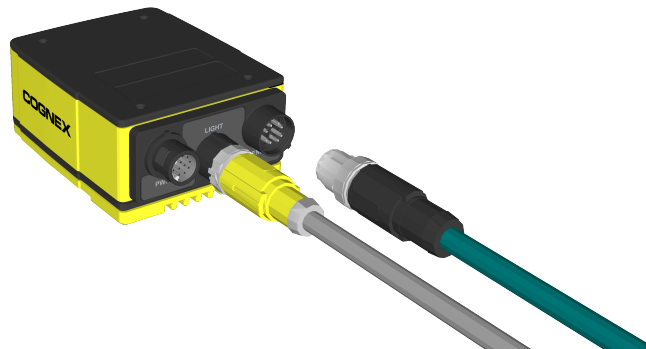

Connect the Breakout Cable

⚠ CAUTION: To reduce emissions, connect the far end of the Breakout cable shield to frame ground.

Note:



- I/O wiring or adjustments to I/O devices should be performed when the vision system is not receiving power.
- Exposed wires can be cut short or wire ends trimmed, and the wires tied back using a tie made of non-conductive material. Keep all bare wires separated from the +24VDC wire.

1. Verify that the 24VDC power supply being used is unplugged and not receiving power.
2. Optionally, connect the I/O wires to an appropriate device (for example, a PLC or a serial device). For more information, refer to [Breakout Cable on page 69](#).
3. Attach the Breakout cable's +24VDC (Red wire) and GND (Black wire) to the corresponding terminals on the power supply.

⚠ CAUTION: Never connect voltages other than 24VDC. Always observe the polarity shown.

4. Connect the Breakout cable's M12 connector to the vision system's PWR connector.

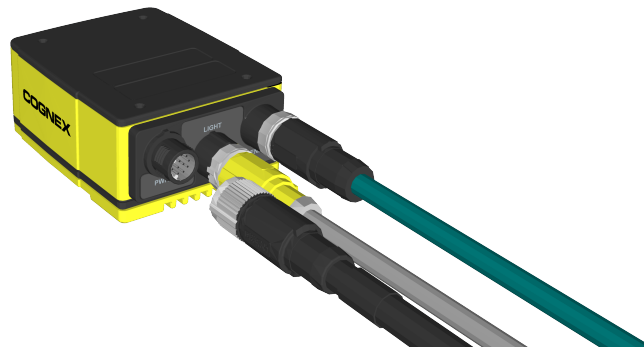

5. Restore power to the 24VDC power supply and turn it on if necessary.

Connect the CIO-MICRO I/O Module (Optional)

Note:

- When connected to the CIO-MICRO I/O module via the I/O Module cable:
 - HS OUT 0 and HS OUT 1 are configurable as NPN (current sinking) or PNP (current sourcing) with 50mA maximum current and the general-purpose outputs are configurable as NPN (current sinking) or PNP (current sourcing) with 100mA maximum current.
- IN 1, IN 2 / HS OUT 2, and IN 3 / HS OUT 3 are not supported.
- The CIO-MICRO I/O module does not support 1000 BaseT pass-through operation. If 1000 BaseT operation is required, you must connect a LAN cable from a Gigabit Ethernet switch to the I/O module's LAN port and connect the vision system's Ethernet cable to the Gigabit Ethernet switch.
- I/O wiring or adjustments to I/O devices should be performed when the vision system is not receiving power.

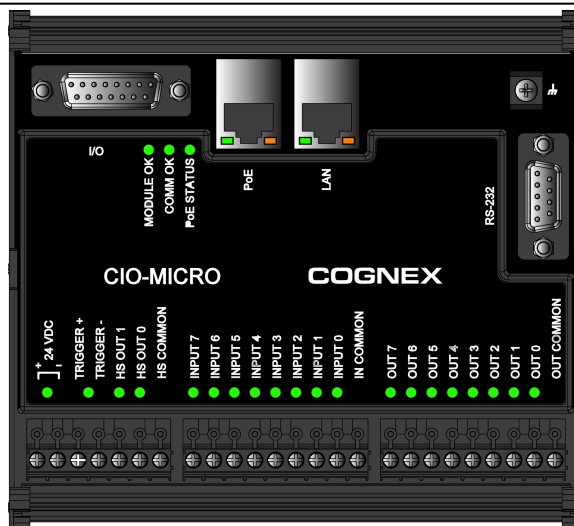

I/O Port	Connects the I/O module to the vision system using the I/O Module cable, and provides power, trigger and high-speed output signals to the vision system.
MODULE OK LED	A green LED illuminates after the I/O module has powered on, has booted up, and is ready to communicate with the vision system.
COMM OK LED	Blinks continuously until the vision system has established a successful connection to the I/O module from In-Sight software. Once successfully connected and communicating properly, the green LED is constantly illuminated.
PoE STATUS LED	Not supported. When the vision system is connected to the I/O module's PoE port, the POE STATUS LED may blink. This is normal and does not affect operation of the vision system.
PoE Port	Connects the I/O module to the vision system, providing the vision system with Ethernet.
PoE Port LEDs	The green LED blinks when a network connection to the vision system is detected. The orange LED blinks when network activity is detected.
LAN Port	Connects the I/O module to an Ethernet network.
LAN Port LEDs	The green LED blinks when a network connection to the local area network is detected. The orange LED blinks when network activity is detected.
Frame Ground Terminal	Connects the I/O module to a frame ground.

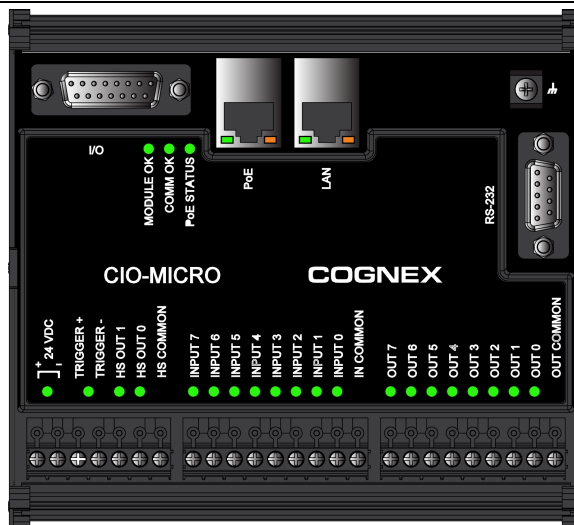

RS-232 Port	Connects the I/O module to an external serial device using an RS-232 (DB9) serial cable. Provides RS-232 communications to the vision system.
High-Speed Output Status LEDs (HS OUT 0 and HS OUT 1)	Illuminates to indicate the high-speed output signal for the In-Sight vision system has switched ON. The LEDs will illuminate even if the I/O module's high-speed terminals are not connected to anything. In addition, the I/O module displays the last known state of the high-speed output line; therefore the LEDs may be illuminated even if the vision system is disconnected from the I/O module.
I/O and Trigger Status LEDs	Illuminates to indicate that an input/output signal has switched ON.
Terminal Blocks	Connects the I/O module to 24VDC power, trigger, external I/O, high-speed outputs and common connections. Note: The I/O module's high-speed output terminals (labeled HS OUT 0 and HS OUT 1) correspond to the vision system's built-in high-speed outputs. These signals are considered high-speed because they pass directly through the I/O module without processing, which provides minimal delay.

1. Connect the I/O module's power wires.

CAUTION: Never connect the I/O module to a power source other than 24VDC. Any other voltage creates a risk of fire or shock and can damage the hardware. Do not connect the 24VDC power source to any terminals other than the 24VDC + and – power terminals.

- a. Verify that the 24VDC power supply being used is unplugged and not receiving power.
- b. Use a screwdriver to loosen the I/O module's power terminals (labeled 24VDC + and –).
- c. Insert the 24VDC + and – wires (16 - 22 AWG, solid or stranded wire) from the power supply into the 24VDC + and – terminals on the I/O module.
- d. Tighten the screw terminals with the screwdriver to secure the wire leads in the terminal block; the maximum torque is 0.1921 Nm (1.7 in-lb).

2. Connect a frame ground wire to the I/O module's Frame Ground terminal. Connect the other end of the frame ground wire to frame ground.

CAUTION: The shield ground connections of the RS-232 port, LAN port, PoE port, I/O port and Frame Ground terminal are internally connected. The system grounding is designed to be at a zero ground potential; this zero ground potential extends through the cable and to peripheral equipment (e.g. a vision system, PLC, etc.). To ensure safe operating conditions, it is strongly recommended that all ground connections are checked to ensure that a zero ground potential is met.

3. Connect the I/O module's I/O wires.
 - a. Determine how I/O devices will be connected to the I/O module's input and output terminals.
 - b. Use a screwdriver to loosen the appropriate screw terminals.
 - c. Connect the input and output wires to the input and output terminals.
 - d. Connect the other end of the input and output wires to the corresponding I/O device.
 - e. Tighten the screw terminals with the screwdriver to secure the wire leads in the terminal block; the maximum torque is 0.1921 Nm (1.7 in-lb).
4. To connect the vision system to a serial device, plug a RS-232 serial cable (DB9 male connector) into the I/O module's RS-232 port and connect the other end of the cable to the serial device. Tighten the connector screws to secure it to the I/O module.
5. Connect to an Ethernet network.
 - a. Connect a LAN cable (RJ-45 connector) to the I/O module's LAN port.
 - b. Connect the other end of the LAN cable to a switch/router or PC, as applicable.
6. Connect the vision system's Ethernet cable.
 - a. Connect the Ethernet cable's M12 connector to the vision system's ENET connector.
 - b. Connect the Ethernet cable's RJ-45 connector to the I/O module's PoE port.
7. Connect the I/O Module cable (CCB-PWRIO-MOD-xx) to the vision system.
 - a. Connect the I/O Module cable's M12 connector to the vision system's PWR connector.
 - b. Connect the I/O Module cable's DB15 connector to the I/O module's I/O connector.
 - c. Restore power to the 24VDC power supply and turn it on if necessary.

Connect the CIO-1400 I/O Expansion Module (Optional)

Note:

- When connected to the CIO-1400 I/O expansion module:
 - HS OUT 0 and HS OUT 1 are configurable as NPN (current sinking) with 50mA maximum current and the general-purpose outputs are configurable as NPN (current sinking) or PNP (sourcing) with 100mA maximum current.
 - IN 1, IN 2 / HS OUT 2, and IN 3 / HS OUT 3 are not supported.
- I/O wiring or adjustments to I/O devices should be performed when the vision system is not receiving power.

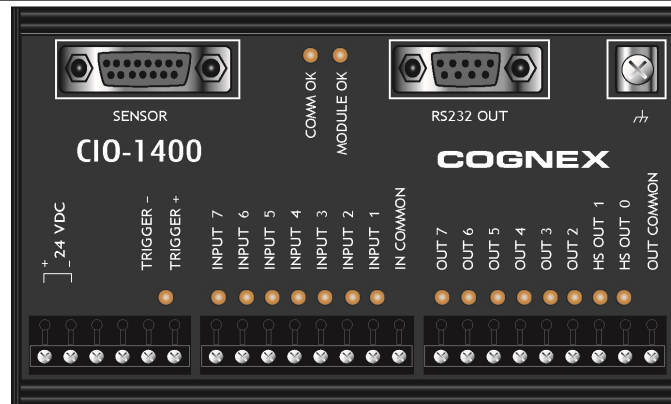

Connector/Indicator	Description
COMM OK LED (yellow)	Illuminates to indicate that the vision system and I/O module are communicating properly.
MODULE OK LED (yellow)	Illuminates after the I/O module has initialized and is ready to communicate with the vision system.
I/O and Trigger Status LEDs (yellow)	Illuminates to indicate when an input/output has switched ON.
SENSOR Port	Connects the I/O module to the vision system using the I/O Module cable, which provides power, trigger, I/O and RS-232 signals to the vision system.
RS232 OUT Port	Connects the I/O module to an RS-232 serial cable, which provides RS-232 communications between the I/O module and an external serial device.
Frame Ground Terminal	Connects the I/O module to a common frame ground.

1. Connect the I/O module's power wires.



CAUTION: Never connect the I/O module to a power source other than 24VDC. Any other voltage creates a risk of fire or shock and can damage the hardware. Do not connect the 24VDC power source to any terminals other than the 24VDC + and – power terminals.

- a. Verify that the 24VDC power supply being used is unplugged and not receiving power.
- b. Use a screwdriver to loosen the I/O module's power terminals (labeled 24VDC + and –).
- c. Insert the 24VDC + and – wires (16 - 26 AWG, solid or stranded wire) from the power supply into the 24VDC + and – terminals on the I/O module.
- d. Tighten the screw terminals with the screwdriver to secure the wire leads in the terminal block; the maximum torque is 0.4 Nm (3.5 in-lb).

2. Connect a frame ground wire to the I/O module's Frame Ground terminal. Connect the other end of the frame ground wire to frame ground.

CAUTION: The shield ground connections of the RS-232 port, SENSOR port and Frame Ground terminal are internally connected. The system grounding is designed to be at a zero ground potential; this zero ground potential extends through the cable and to peripheral equipment (e.g. a vision system, PLC, etc.). To ensure safe operating conditions, it is strongly recommended that all ground connections are checked to ensure that a zero ground potential is met.

3. Connect the I/O module's I/O wires.
 - a. Determine how I/O devices will be connected to the I/O module's input and output terminals.
 - b. Use a screwdriver to loosen the appropriate screw terminals.
 - c. Connect the input and output wires to the input and output terminals.
 - d. Connect the other end of the input and output wires to the corresponding I/O device.
 - e. Tighten the screw terminals with the screwdriver to secure the wire leads in the terminal block; the maximum torque is 0.4 Nm (3.5 in-lb).
4. To connect the vision system to a serial device, plug an RS-232 serial cable (DB9 male connector) into the I/O module's RS232 OUT port and connect the other end of the cable to the serial device. Tighten the connector screws to secure it to the I/O module.
5. Connect the I/O Module cable (CCB-PWRIO-MOD-xx) to the vision system.
 - a. Connect the I/O Module cable's M12 connector to the vision system's PWR connector.
 - b. Connect the I/O Module cable's DB15 connector to the I/O module's SENSOR connector.
 - c. Restore power to the 24VDC power supply and turn it on if necessary.

Replace the SD Card (Optional)

The vision system is equipped with a Micro SD card slot and an 8GB SD card is pre-installed for saving job and image files. Complete the following steps to replace the pre-installed SD card.

Note: The vision system supports SD cards formatted with a FAT32 file system.

CAUTION:

- Hot-plugging the SD card is not supported and may damage the SD card and/or lead to unexpected behavior.
- IP67 protection requires that all cables are properly attached (or the provided connector plug installed), the IP67-rated lens cover or illumination accessory is properly installed and the Micro SD card cover is fastened in place.
- Observe ESD precautions when installing or removing an SD card or other accessories.

1. Remove power from the vision system.
2. Unscrew the screws in the Micro SD card cover to open the card slot.
3. Remove the existing SD card from the Micro SD card slot.
4. Insert the new SD card into the Micro SD card slot, ensuring the card is properly oriented.
5. Replace the SD card cover, reinsert the screws and torque screws to 0.18 Nm (25 in-oz).



6. Restore power to the vision system.

Replace the LED Ring Light (Optional)

The illumination accessory (ISLM-7000-WHI) has a white LED ring light pre-installed. Complete the following steps to replace the pre-installed LED ring light.

CAUTION:

- Do not hot-plug the illumination accessory; verify the vision system is not receiving power when connecting or disconnecting the illumination accessory. Failure to remove power during this procedure may result in damage to the vision system and/or the illumination accessory.
- Tighten all of the illumination accessory screws in the following sequence.

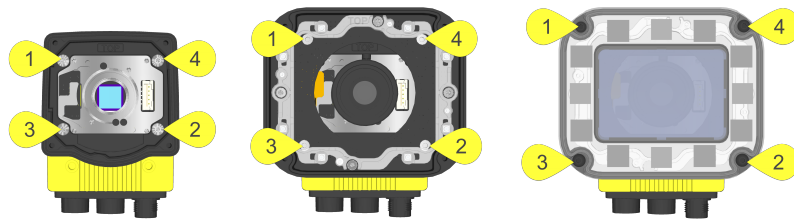

1. Remove power from the vision system.
2. Use a 2mm hex wrench to remove the four M3 x 12mm screws from the front cover. Remove the front cover.

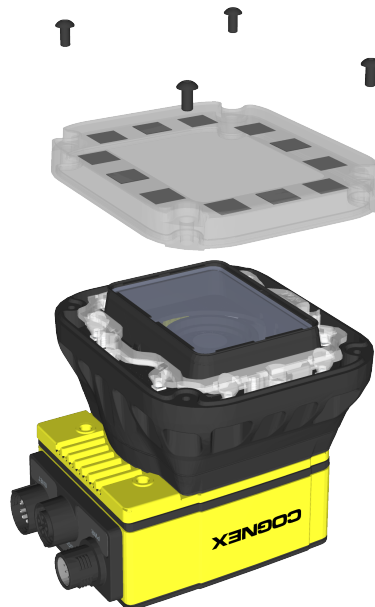

3. Remove the keyed light baffle.

Note: The following graphic includes an optional bandpass filter accessory installed to the light baffle. For more information, refer to [Illumination Accessory C-Mount Lenses, Lens Covers and Lights on page 12](#).

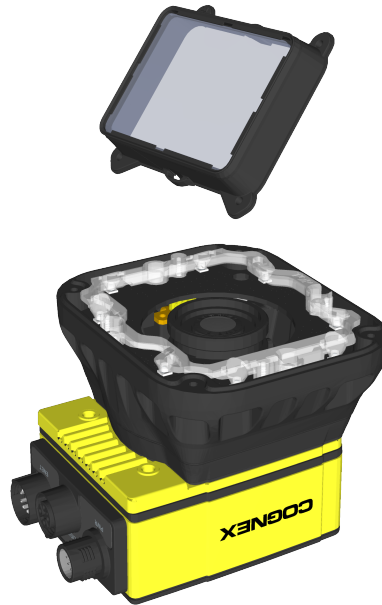

4. Use a 2mm hex wrench to remove the four M2.5 x 6mm screws from the LED ring light. The screw holes are indicated by a triangle symbol ▶. Remove the LED ring light from the light housing.

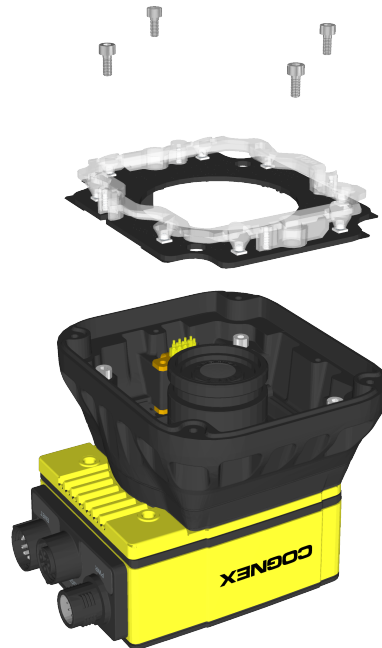

5. Place the new LED ring light inside the light housing, with "TOP" oriented upward. Insert the four M2.5 x 6mm screws into the screw holes indicated by a triangle symbol ►. Tighten the screws using a 2mm hex wrench; the maximum torque is 0.34 Nm (3 in-lb).

CAUTION: Do not hot-plug the LED ring light; verify the vision system is not receiving power when connecting or disconnecting the LED ring light.

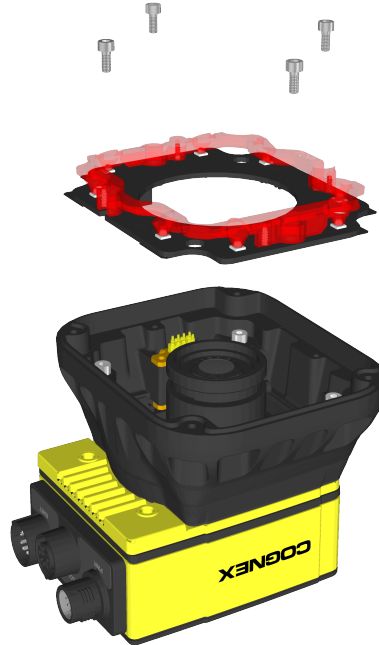

- The light baffle is keyed to fit the LED ring light structure and snaps into place with the keyed tabs sitting flush over each light housing captive screw access hole. Tilt the light baffle toward the light housing and maneuver the light baffle past the top of the LED ring light structure. Compress the light baffle and maneuver the bottom of the light baffle past the bottom of the LED ring light structure until the light baffle snaps into place.

Note: The following graphic includes an optional bandpass filter accessory installed to the light baffle. For more information, refer to [In-Sight Lenses, Lens Covers and Lights on page 10](#).

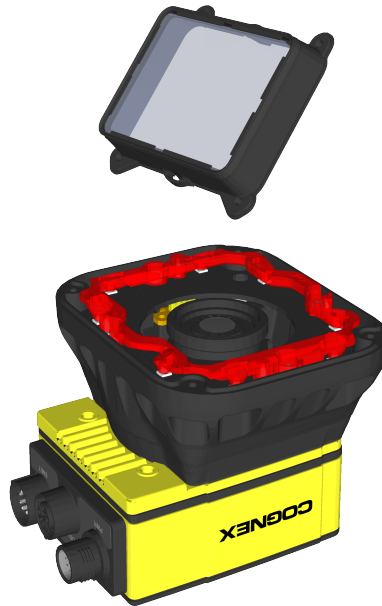

- Place the light cover on the light housing. Align the central clear region of the light cover with the light baffle edges. Insert the four M3 x 12mm screws and use a 2mm hex wrench to torque screws to 0.31 Nm (2.75 in-lb).

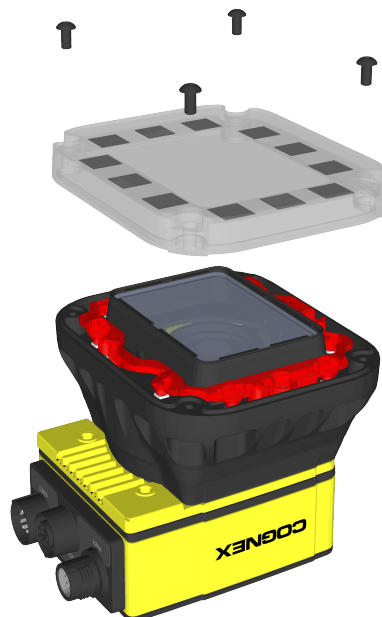

- Restore power to the vision system.

Replace the M12 Autofocus Lens (Optional)

The autofocus accessory (ISAF-7000-8mm) has an 8mm M12 lens pre-installed. Complete the following steps to replace the pre-installed M12 lens.

CAUTION:

- Do not hot-plug the illumination accessory; verify the vision system is not receiving power when connecting or disconnecting the illumination accessory. Failure to remove power during this procedure may result in damage to the vision system and/or the illumination accessory.
- Tighten all of the illumination accessory screws in the following sequence.

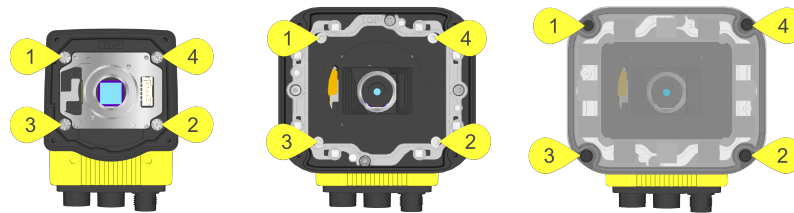

1. If the autofocus module is already installed to the vision system, you must first log onto the vision system using In-Sight Explorer software and reset the focus position to 0. Refer to the *In-Sight® Explorer Help* file for more information.
2. Remove power from the vision system.
3. Use a 2mm hex wrench to remove the four M3 x 12mm screws from the front cover. Remove the front cover.

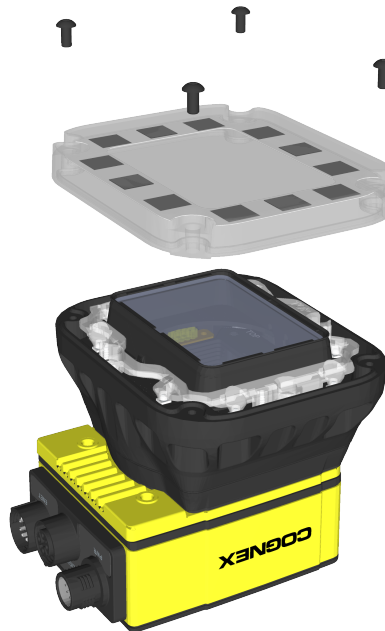

4. Remove the keyed light baffle.

Note: The following graphic includes an optional bandpass filter accessory installed to the light baffle. For more information, refer to [S-Mount/M12 Autofocus Accessories on page 13](#).

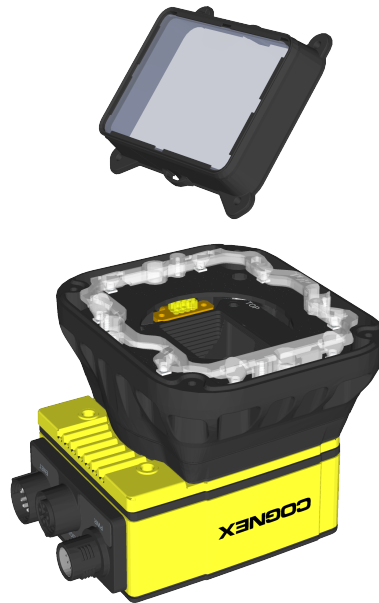

5. The light housing contains four captive screws that are accessible via captive screw access holes in the LED ring light board. Use a 2mm hex wrench to loosen the four captive screws in the light housing. Remove the light housing.

CAUTION:

- Do not hot-plug the LED ring light; verify the vision system is not receiving power when connecting or disconnecting the LED ring light.
- A connector protrudes from the underside of the light housing and can be damaged if placed on a hard surface.



- Use a 1.5mm hex wrench to loosen the three captive screws in the autofocus module. Remove the autofocus module from the vision system.

CAUTION: Do not hot-plug the autofocus module; verify the vision system is not receiving power when connecting or disconnecting the autofocus module.



- The M12 lens is held in place with a blue threaded lens nut on the underside of the autofocus module. A lens tool is included with the lens toolkit accessory (ISAF-7000-TOOL). Place the lens tool directly on the lens, with the padded end of the tool pressed against the lens.

CAUTION: Use light axial force on the lens tool when installing or removing the lens.

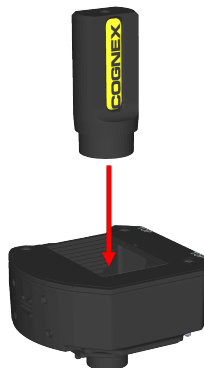

Holding the lens tool in place, remove the blue lens nut from the lens.



8. Remove the M12 lens from the autofocus module.

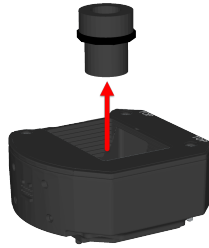

9. An extra black lens nut is included with the lens toolkit accessory (ISAF-7000-TOOL). Thread this black lens nut on the new M12 lens until snug.



10. Drop the new M12 lens into the module.

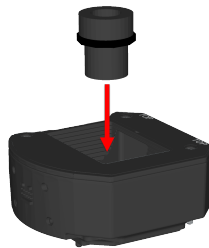

11. Quarter turn the thread of the lens clockwise, to ensure the lens is seated in the lens carrier.



12. Once the lens is in the module, place the lens tool directly on the lens, with the padded end of the tool pressed against the lens. With the chamfer side of the blue lens nut facing the module, thread the blue lens nut on the lens and finger-tighten until snug. The lens nut should be tight enough that it does not fall off due to vibration.

CAUTION: Use light axial force on the lens tool when installing or removing the lens.

Chamfer Side of Blue Lens Nut:

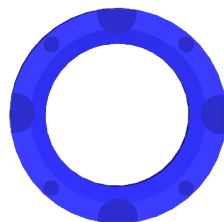

- There are two alignment pins on the base of the autofocus module; seat the pins into the vision system faceplate. There are three captive screws in the autofocus module; partially thread the screws into the vision system faceplate using a 1.5mm hex wrench. Once threaded, torque screws to 0.5 Nm (4.43 in-lb) using a torque screwdriver with a 1.5mm hex torque bit capable of reaching 15mm into a 2.5mm diameter hole (for example, Wiha Tools 1.5mm Hex Metric Torque Blade [SKU 28545] used with the Adjustable Torque Handle [SKU 28550]).



- Place the light housing with LED ring light on top of the spacer, with "TOP" oriented upward. Verify seating of the gasket on the top of the spacer. There are four captive screw access holes near the white circles on the LED ring light. Use a 2mm hex wrench to torque captive screws to 0.34 Nm (3 in-lb).

CAUTION: Do not hot-plug the LED ring light; verify the vision system is not receiving power when connecting or disconnecting the LED ring light.



- The light baffle is keyed to fit the LED ring light structure and snaps into place with the keyed tabs sitting flush over each light housing captive screw access hole. Tilt the light baffle toward the light housing and maneuver the light baffle past the top of the LED ring light structure. Compress the light baffle and maneuver the bottom of the light baffle past the bottom of the LED ring light structure until the light baffle snaps into place.

Note: The following graphic includes an optional bandpass filter accessory installed to the light baffle. For more information, refer to [In-Sight Lenses, Lens Covers and Lights on page 10](#).

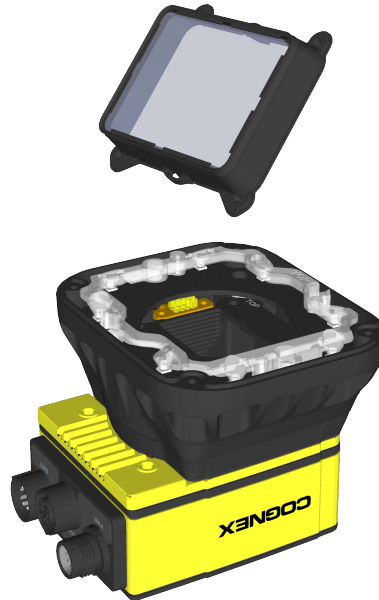

- Place the light cover on the light baffle. Align the central clear region of the light cover with the light baffle edges. Insert the four M3 x 12mm screws and use a 2mm hex wrench to torque screws to 0.31 Nm (2.75 in-lb).

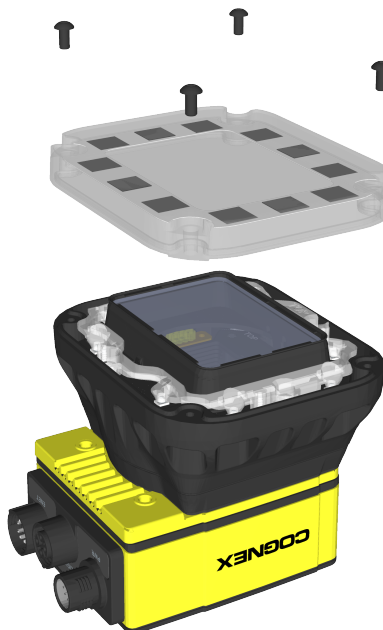

- Restore power to the vision system.

Remove the Illumination Accessory PCB

If the illumination accessory (ISLM-7000-WHI) must be uninstalled from the vision system, complete the following steps to safely remove the PCB and avoid damage to the vision system.

CAUTION: Do not hot-plug the illumination accessory; verify the vision system is not receiving power when connecting or disconnecting the illumination accessory. Failure to remove power during this procedure may result in damage to the vision system and/or the illumination accessory.

1. Remove power from the vision system.
2. Use a 2mm hex wrench to remove the four M3 x 6mm spacer screws. Remove the spacer.

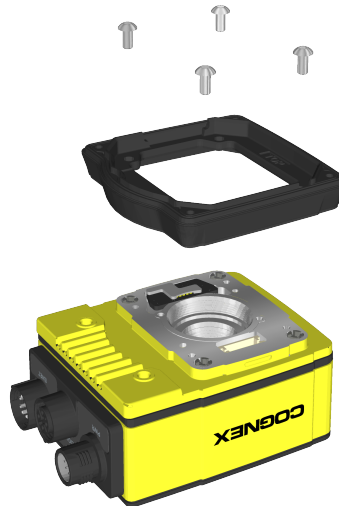

3. The vision system faceplate includes two lift points on either side of the PCB. Position an insulated extractor tool (for example, Jonard Tools S-340 DIP/IC Extractor) under the edges of the PCB.

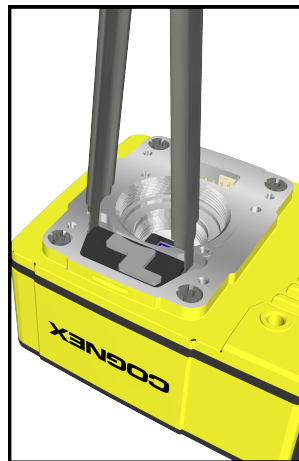

- Once the extractor is engaged under the edges of the PCB, gently pull upward to disengage the PCB from the internal connector and remove the PCB.

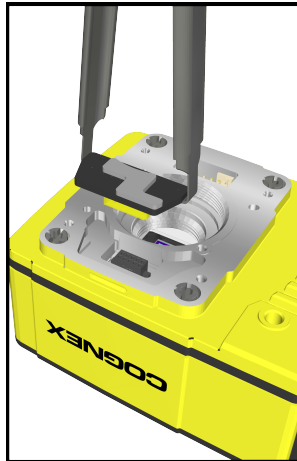

- Verify the removal process did not damage mating components.

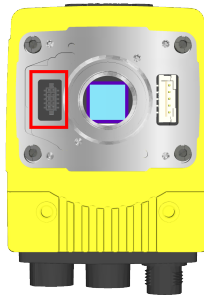

Specifications

The following sections list general specifications for the vision system.

Vision System Specifications

Specifications	7600	7600C	7800	7800C	7801	7801C	7802	7802C
Minimum Firmware Requirement	In-Sight version 5.4.0	In-Sight version 5.5.0	In-Sight version 5.4.0	In-Sight version 5.5.0	In-Sight version 5.4.0	In-Sight version 5.5.0	In-Sight version 5.4.0	In-Sight version 5.5.0
Job/Program Memory	7.2GB non-volatile flash memory; unlimited storage via remote network device.							
Image Processing Memory	512MB SDRAM							
SD Card	1 Micro SD card slot with an 8GB SD card pre-installed for saving job and image files. The vision system supports SD cards formatted with a FAT32 file system.							
Sensor Type	1/1.8 inch CMOS, global shutter							
Sensor Properties	4.5mm diagonal, 4.5 x 4.5µm sq. pixels				7.38mm diagonal, 4.5 x 4.5µm sq. pixels		9mm diagonal, 4.5 x 4.5µm sq. pixels	
Maximum Image Resolution (pixels) ¹	800 x 600 ²				1280 x 1024		1600 x 1200 ³	
	640 x 480						800 x 600 (Low Light Mode)	
Electronic Shutter Speed	800 x 600: 14µs to 550ms				17µs to 750ms		1600 x 1200: 20µs to 940ms	
	640 x 480: 14µs to 520ms						800 x 600 (Low Light Mode): 20µs to 940ms	
Acquisition	Rapid reset, progressive scan, full-frame integration.							
Bit Depth	256 grey levels (8 bits/pixel)	24-bit color	256 grey levels (8 bits/pixel)	24-bit color	256 grey levels (8 bits/pixel)	24-bit color	256 grey levels (8 bits/pixel)	24-bit color
Frames Per Second (FPS) ⁴	800 x 600: 165 FPS	800 x 600: 100 FPS	800 x 600: 165 FPS	800 x 600: 100 FPS	76 FPS	45 FPS	1600 x 1200: 53 FPS	1600 x 1200: 33 FPS
	640 x 480: 217FPS	640 x 480: 135 FPS	640 x 480: 217 FPS	640 x 480: 135 FPS			800 x 600 (Low Light Mode): 53 FPS	800 x 600 (Low Light Mode): 45 FPS
Lens Type	C-Mount or S-Mount/M12							
Trigger	1 opto-isolated, acquisition trigger input.							

¹ The number of image sensor rows are configurable and can be set within the In-Sight Explorer software. Decreasing the number of rows will increase the number of frames per second acquired by the vision system. Refer to the AcquireImage topic in the *In-Sight® Explorer Help* file for more information.

² The default resolution for the In-Sight 7600, 7600C, 7800 and 7800C vision system is 800 x 600 pixels. The vision system's resolution can be configured as 640 x 480 pixels within the In-Sight Explorer software. Refer to the *In-Sight® Explorer Help* file for more information.

³ The default resolution for the In-Sight 7802 and 7802C vision system is 1600 x 1200 pixels. The vision system's resolution can be configured as 800 x 600 (Low Light Mode) within the In-Sight Explorer software. When using 800 x 600 (Low Light Mode), it provides increased light sensitivity at a reduced resolution. Refer to the *In-Sight® Explorer Help* file for more information.

⁴ Maximum frames per second is job-dependent, based on the minimum exposure for a full image frame capture using the dedicated acquisition trigger, and assumes there is no user interface connection to the vision system.

Specifications	7600	7600C	7800	7800C	7801	7801C	7802	7802C
Discrete Inputs	<ul style="list-style-type: none"> • 3 general-purpose inputs when connected to the Breakout cable.¹ • 8 general-purpose inputs available when connected to the CIO-MICRO I/O Module via the I/O module cable. • 7 general-purpose inputs available when connected to the CIO-1400 I/O Module via the I/O module cable. 							
Discrete Outputs	<ul style="list-style-type: none"> • 4 high-speed outputs when connected to the Breakout cable.² • 2 high-speed outputs, plus 8 general-purpose outputs available when connected to the CIO-MICRO I/O Module via the I/O module cable. • 2 high-speed outputs, plus 6 general-purpose outputs available when connected to the CIO-1400 I/O Module via the I/O module cable. 							
Status LEDs	SD Card Status, Pass/Fail LED and Indicator Ring, Network LED and Error LED.							
Internal LED Ring Light	White, Red, Blue or IR LED ring light used with the illumination accessory (ISLM-7000-WHI). <ul style="list-style-type: none"> • White LED color temperature: 4000 K • Red LED wavelength: 617 nm • Blue LED wavelength: 455 nm • IR LED wavelength: 850 nm 							
	 Note: Refer to DataMan documentation for DataMan accessory specifications.							
Autofocus - Number of Focus Cycles	20,000							
Network Communication	1 Ethernet port, 10/100/1000 BaseT with auto MDIX. IEEE 802.3 TCP/IP Protocol. Supports DHCP, static and link-local IP address configuration.							
1588 Support	Timestamp Resolution: 8ns Synchronization Accuracy Through Transparent Clock: 5µs							
Serial Communication	RS-232C when connected to the Breakout cable ³ or a compatible I/O module.							
Power Consumption	24VDC ±10%, 1.5A maximum							
Power Output	24VDC @ 750mA maximum to external light.							
Material	Die-cast and extruded aluminum housing.							
Finish	Painted.							
Mounting	Four M3 threaded mounting holes. 1/4-20, M6 and flathead mounting holes also available on mounting bracket accessory (ISB-7000-7K). M4 mounting holes also available on mounting bracket accessory (ISB-7000-5K).							

¹ When connected to the Breakout cable, the vision system allows for bi-directional high-speed outputs and general-purpose inputs for HS OUT 2 / IN 2 and HS OUT 3 / IN 3. These lines are configured as outputs by default.

² When connected to the Breakout cable, the vision system allows for bi-directional high-speed outputs and general-purpose inputs for HS OUT 2 / IN 2 and HS OUT 3 / IN 3. These lines are configured as outputs by default.

³ If hardware handshaking is required, an I/O module must be used.

Specifications	7600	7600C	7800	7800C	7801	7801C	7802	7802C
Dimensions	<ul style="list-style-type: none"> • 35.7mm (1.41in) x 60.5mm (2.38in) x 90.1mm (3.55in). • 81.7mm (3.21in) x 60.5mm (2.38in) x 90.1mm (3.55in) with standard lens cover accessory (COV-7000-CMNT). • 102.7mm (4.04in) x 60.5mm (2.38in) x 90.1mm (3.55in) with extended lens cover accessory (COV-7000-CMNT-EX). • 77.4mm (3.05in) x 88.9mm (3.50in) x 97.2mm (3.83in) with illumination accessory (ISLM-7000-WHI). 							
Weight	240 g (8.47 oz.), with no accessories attached.							
Case Temperature ¹	0°C to 50°C (32°F to 122°F).							
Storage Temperature	-20°C to 80°C (-4°F to 176°F)							
Humidity	< 80% non-condensing							
Protection	IP67 with all cables properly attached (or the provided connector plug installed), the IP67-rated lens cover or illumination accessory properly installed and the Micro SD card cover fastened in place.							
Shock (Shipping and Storage)	IEC 60068-2-27: 18 shocks (3 shocks in each polarity in each (X, Y, Z) axis) 80 Gs (800m/s ² at 11ms, half-sinusoidal) with cables or cable plugs and appropriate lens cover attached.							
Vibration (Shipping and Storage)	IEC 60068-2-6: vibration test in each of the three main axis for 2 hours @ 10 Gs (10 to 500 Hz at 100m/s ² / 15mm) with cables or cable plugs and appropriate lens cover attached.							
Regulations/Conformity	CE, FCC, KCC, TÜV SÜD NRTL, EU RoHS, China RoHS							

¹ Case temperature can be verified using the EV GetSystemConfig("Internal.Temperature") Extended Native Mode command. When issued, it returns the vision system's internal temperature in degrees Celsius, which will be about 3 to 5 degrees above the vision system case temperature. Refer to the *In-Sight® Explorer Help* file for more information. A thermal scanner can also be used to determine the vision system case temperature. Additional cooling measures are required if the case temperature cannot be kept below 50°C. Examples of such measures include: extra heat sinking and/or air movement.

Acquisition Trigger

The vision system features one acquisition trigger input, which is optically isolated. The acquisition trigger input can be configured to trigger from either an NPN (current sinking) or PNP (current sourcing) device.

Specification	Description
V_{IH}	± 15 — ± 28 V
V_{IL}	0 — ± 5 V
I_{TYP}	@ 12 VDC, 2.0 mA
	@ 24 VDC, 4.2 mA
Delay	190 μ s maximum latency between leading edge of trigger and start of acquisition. Input pulse should be minimum of 1ms wide.

- To trigger from an NPN type photoelectric sensor or PLC output, connect **COMMON IN** to +24V and connect **TRIGGER** to the output of the photoelectric sensor. When the output turns on, it pulls **TRIGGER** down to 0V, turning the opto-coupler on. For more information, refer to [Breakout Cable on page 69](#).
- To trigger from a PNP photoelectric sensor or PLC output, connect **Trigger** to the output of the photoelectric sensor and connect **COMMON IN** to 0V. When the output turns on, it pulls **TRIGGER** up to +24V, turning the opto-coupler ON. For more information, refer to [Breakout Cable on page 69](#).

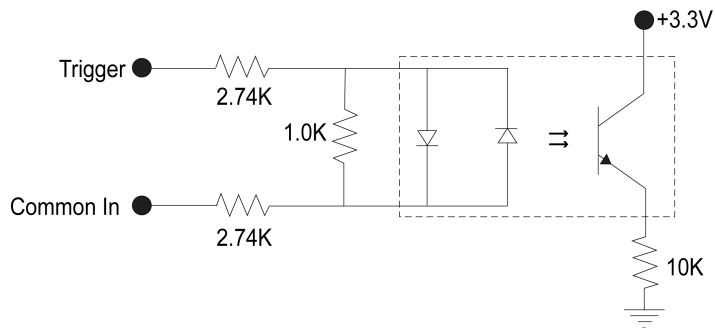

26.4V Max. across input pins - Transition approximately 12V (Min.)

General-Purpose Inputs

The vision system features three¹ built-in general-purpose inputs, which are optically isolated. The inputs can be configured as either NPN (current sinking) or PNP (current sourcing) lines.

Specification	Description
V_{IH}	± 15 — ± 28 V
V_{IL}	0 — ± 5 V
I_{TYP}	@ 12 VDC, 2.0 mA
	@ 24 VDC, 4.2 mA
Delay	1.11ms maximum latency between leading edge of trigger and start of acquisition. Input pulse should be minimum of 1ms wide.

For NPN lines, to utilize an input, connect **Common In** to +24V and connect **In 1** to the output of the photoelectric sensor or PLC. When the output turns on, it pulls **In 1** down to 0V, turning the opto-coupler on.

For PNP lines, to utilize an input, connect **In 1** to the output of the detector and connect **Common In** to 0V. When the output turns on, it pulls **In 1** up to +24V, turning the opto-coupler ON.

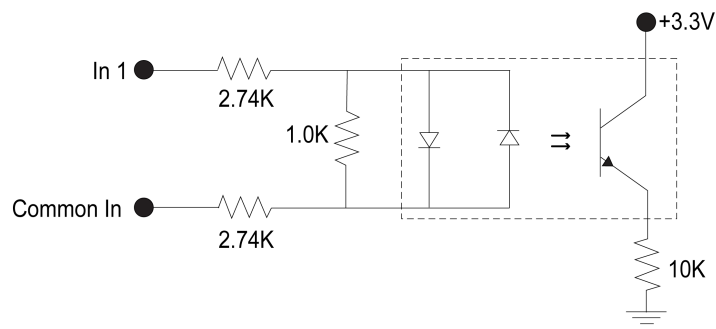

26.4V Max. across input pins - Transition approximately 12V (Min.)

¹ When connected to the Breakout cable, the vision system allows for bi-directional high-speed outputs and general-purpose inputs for HS OUT 2 / IN 2 and HS OUT 3 / IN 3. These lines are configured as outputs by default.

High-Speed Outputs

The vision system features four¹ built-in, high-speed outputs, which are optically isolated. The high-speed outputs can be used as either NPN (current sinking) or PNP (current sourcing) lines.

Specification	Description
Voltage	26.4V maximum through external load
Current	50mA maximum sink current
	OFF state leakage current 100 μ A
	External load resistance 240 Ohms to 10K Ohms
	Each line rated at a maximum 50mA, protected against over-current, short circuits and transients from switching inductive loads. High current inductive loads require external protection diode.
Delay ²	10 μ s (maximum due to opto-isolators turning ON).

For NPN lines, the external load should be connected between the output and the positive supply voltage (<26.4V). The output pulls down to less than 3V when ON, which causes current to flow through the load. When the output is OFF, no current flows through the load.

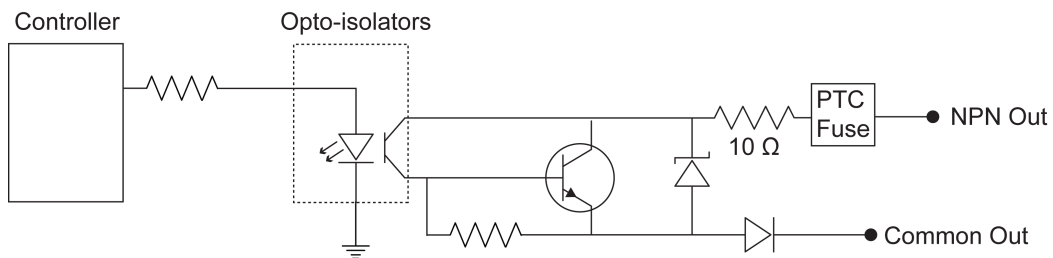

For PNP lines, the external load should be connected between the output and the negative supply voltage (0V). When connected to a 24VDC power supply, the output pulls up greater than 21V when ON, and current flows through the load. When the output is OFF, no current flows through the load.

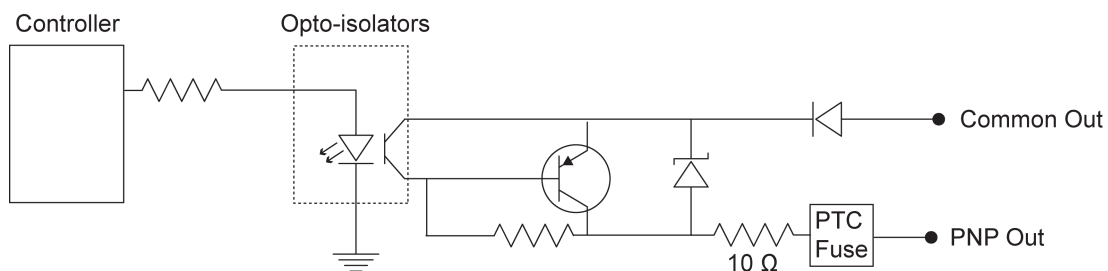

¹ When connected to the Breakout cable, the vision system allows for bi-directional high-speed outputs and general-purpose inputs for HS OUT 2 / IN 2 and HS OUT 3 / IN 3. These lines are configured as outputs by default.

² Delay when opto-isolators turn OFF depends on the load to which the output is connected. With a 240 Ohm load, the maximum delay will be 200 μ s.

High-Speed Output Wiring

To connect to an NPN-compatible PLC input, connect High-Speed Output 0, Output 1, Output 2 or Output 3 directly to the PLC input. When enabled, the output pulls the PLC input down to less than 3V.

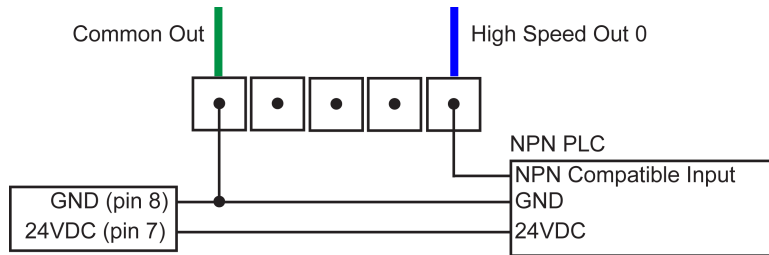

To connect to a PNP-compatible PLC input, connect High-Speed Output 0, Output 1, Output 2 or Output 3 directly to the PLC input. When enabled, the output pulls the PLC input up to greater than 21V.

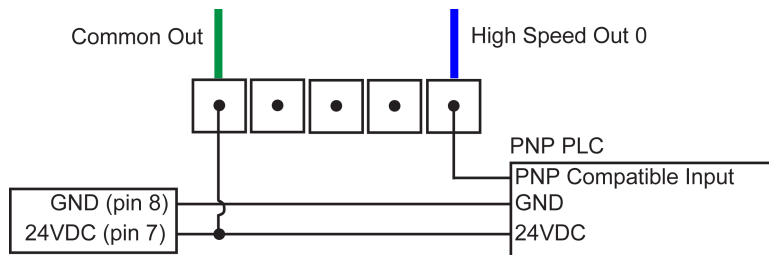

To connect the high-speed outputs to a relay, LED or similar load, connect the negative side of the load to the output and the positive side to +24V. When the output switches on, the negative side of the load is pulled down to less than 3V, and 24V appears across the load. Use a protection diode for a large inductive load, with the anode connected to the output and the cathode connected to +24V.

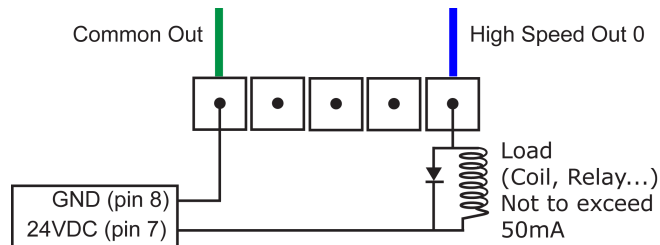

External Light Connector

The vision system's LIGHT connector is used to connect the External Light cable to an external lighting device, providing power and strobe control. The External Light cable can be connected to either a continuous or strobed lighting device. Before using an external lighting device, you must use the Light Settings dialog within In-Sight Explorer to configure the light settings. For more information, refer to the Light Settings topic in the *In-Sight® Explorer Help* file.

Note: The External Light cable CCB-M12LTF-xx does not support intensity control. If intensity control is required, use External Light cables with the following product IDs: IVSL-5PM12-J300, IVSL-5PM12-J500, IVSL-5PM12-J1000 and IVSL-5PM12-J2000.

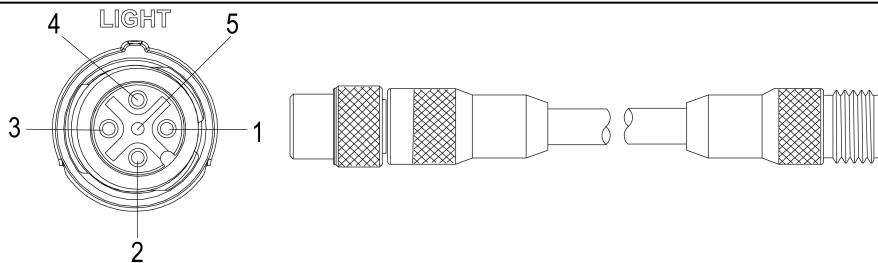

Pin#	Signal Name	Wire Color
1	+24VDC	Brown
2	Intensity Control	White
3	GND	Blue
4	Strobe	Black
5	Chassis	Not Connected

Note:

- Cables are sold separately.
- Current load: average 500mA, peak 1A (max. 100µs).



- Only the +24VDC pin is capable of sourcing 500mA.
- The Strobe output is active low 0VDC and active high +12VDC, with the Polarity configured in the Light Settings dialog within In-Sight Explorer. It is a control signal only and should not to be used as a high current path. Power should be sourced from +24VDC and GND.

Ethernet Cable

The RJ-45 to M12 X-coded Ethernet cable provides Ethernet connectivity and supplies power to the vision system.

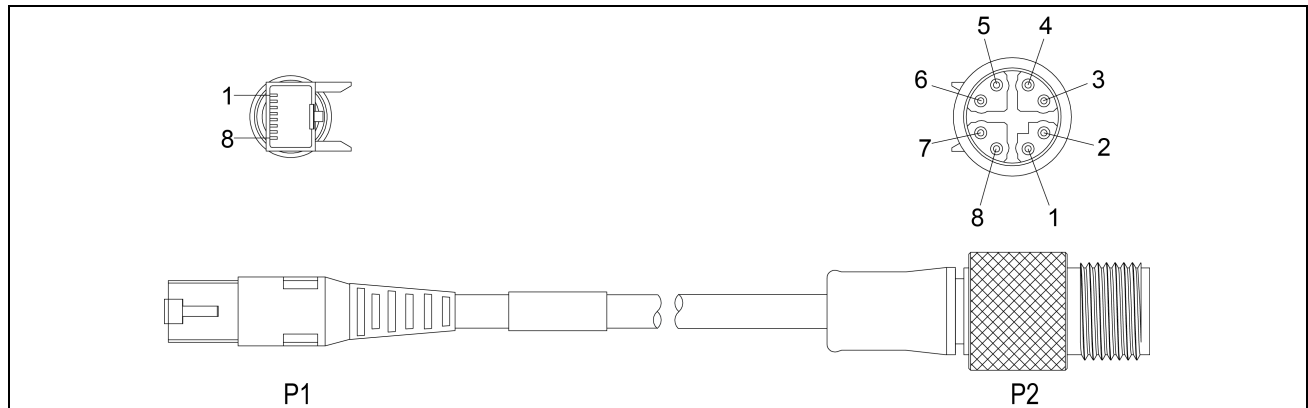

P1 Pin Number	Wire Color	Signal Name	P2 Pin Number
1	White/Orange	TxRx A +	1
2	Orange	TxRx A -	2
3	White/Green	TxRx B +	3
4	Blue	TxRx C +	8
5	White/Blue	TxRx C -	7
6	Green	TxRx B -	4
7	White/Brown	TxRx D +	5
8	Brown	TxRx D -	6

Note:



- Cables are sold separately.
- The wiring for this cable follows standard industrial Ethernet M12 specifications. This differs from the 568B standard.

CAUTION: The Ethernet cable shield must be grounded at the far end. Whatever this cable is plugged into (usually a switch or router) should have a grounded Ethernet connector. A digital voltmeter should be used to validate the grounding. If the far end device is not grounded, a ground wire should be added in compliance with local electrical codes.

Breakout Cable

The Breakout cable provides connections to an external power supply, the acquisition trigger input, general-purpose inputs, high-speed outputs, and RS-232 serial communications. The Breakout cable is not terminated.

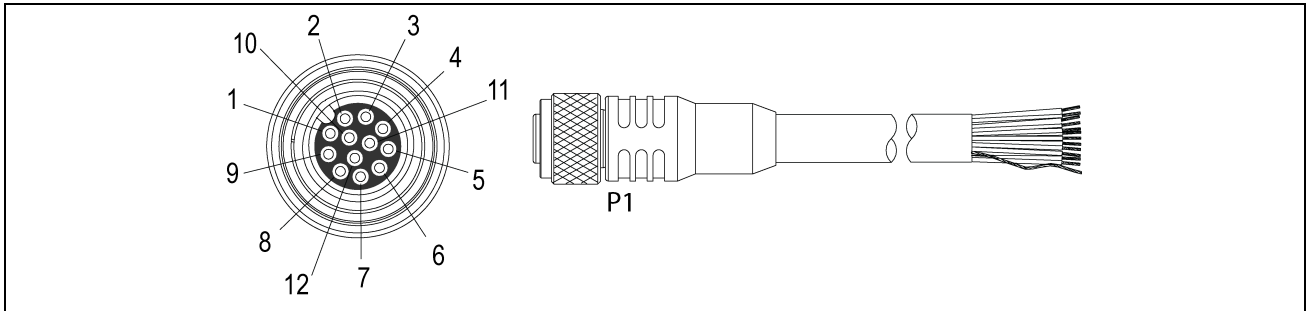

Pin#	Signal Name	Wire Color
1	IN 2 / HS OUT 2	Yellow
2	RS-232 TRANSMIT ¹	White/Yellow
3	RS-232 RECEIVE ²	Brown
4	IN 3 / HS OUT 3	White/Brown
5	IN 1	Violet
6	COMMON IN	White/Violet
7	+24VDC	Red
8	GND	Black
9	COMMON OUT	Green
10	TRIGGER	Orange
11	HS OUT 0	Blue
12	HS OUT 1	Grey

Note:

- Cables are sold separately.
- Exposed wires can be cut short or wire ends trimmed, and the wires tied back using a tie made of non-conductive material. Keep all bare wires separated from the +24VDC wire.
- I/O wiring or adjustments to I/O devices should be performed when the vision system is not receiving power.

¹ If hardware handshaking is required, an I/O module must be used.

² If hardware handshaking is required, an I/O module must be used.

I/O Module Cable

The I/O Module cable connects the vision system directly to a compatible I/O module via the DB15 connector. When the I/O module is used, all power and communication lines used by the vision system are connected using the I/O Module cable.

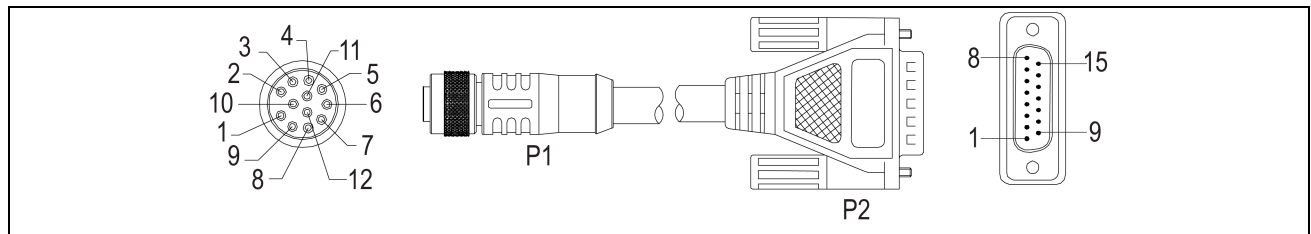

P1 Pin#	Signal Name	Wire Color	Signal Name	P2 Pin#
1	IN 2 / HS OUT 2	Yellow	Not Used	Not Used
2	RS-232 TRANSMIT	White/Yellow	RS-232 TRANSMIT	7
3	RS-232 RECEIVE	Brown	RS-232 RECEIVE	6
4	IN 3 / HS OUT 3	White/Brown	Not Used	Not Used
5	IN 1	Violet	Not Used	Not Used
6	COMMON IN	White/Violet	TRIGGER-	3
7	+24VDC	Red	+24VDC	1
8	GND	Black	-24VDC	8
9	COMMON OUT	Green	-24VDC	8
10	TRIGGER	Orange	TRIGGER+	2
11	HS OUT 0	Blue	HS OUT 0	4
12	HS OUT 1	Grey	HS OUT 1	5

Note: Cables are sold separately.

Vision System Dimensions

Note:



- All dimensions are in millimeters [inches] and are for reference purposes only.
- All specifications are for reference purpose only and may be changed without notice.

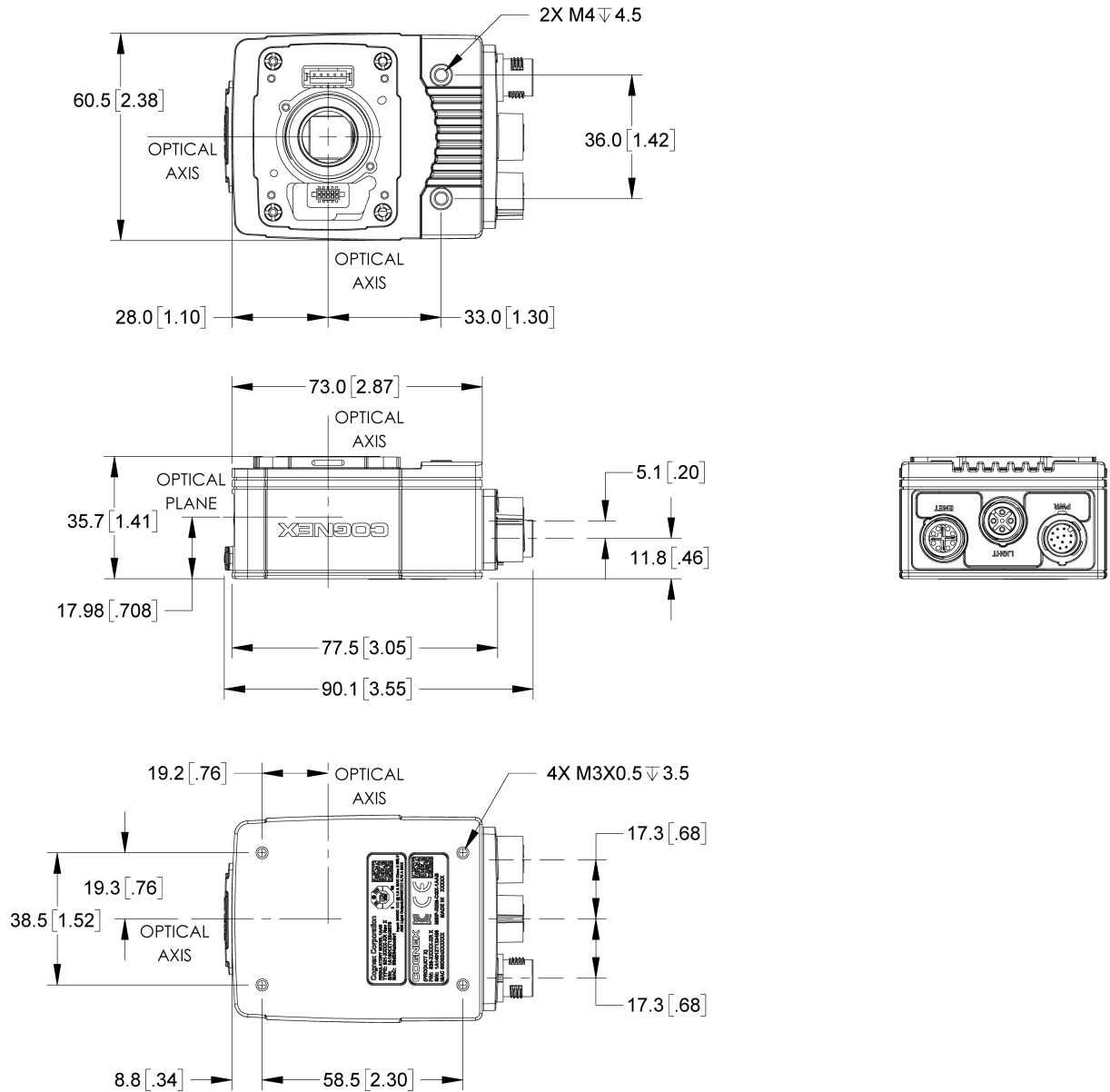

Vision System Dimensions with Standard Lens Cover (COV-7000-CMNT)

Note:



- All dimensions are in millimeters [inches] and are for reference purposes only.
- All specifications are for reference purpose only and may be changed without notice.

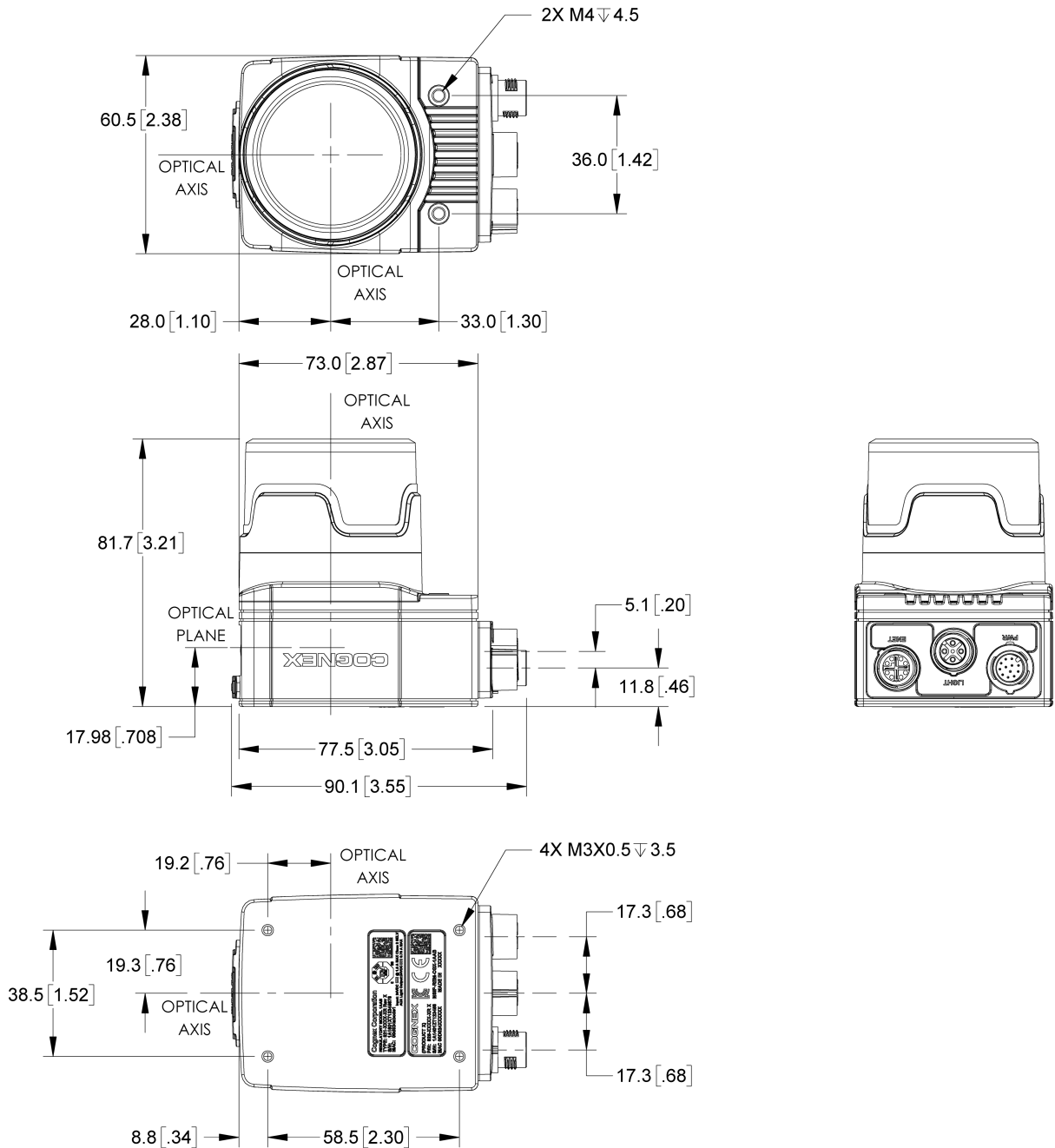

Vision System Dimensions with Extended Lens Cover (COV-7000-CMNT-EX)

Note:



- All dimensions are in millimeters [inches] and are for reference purposes only.
- All specifications are for reference purpose only and may be changed without notice.

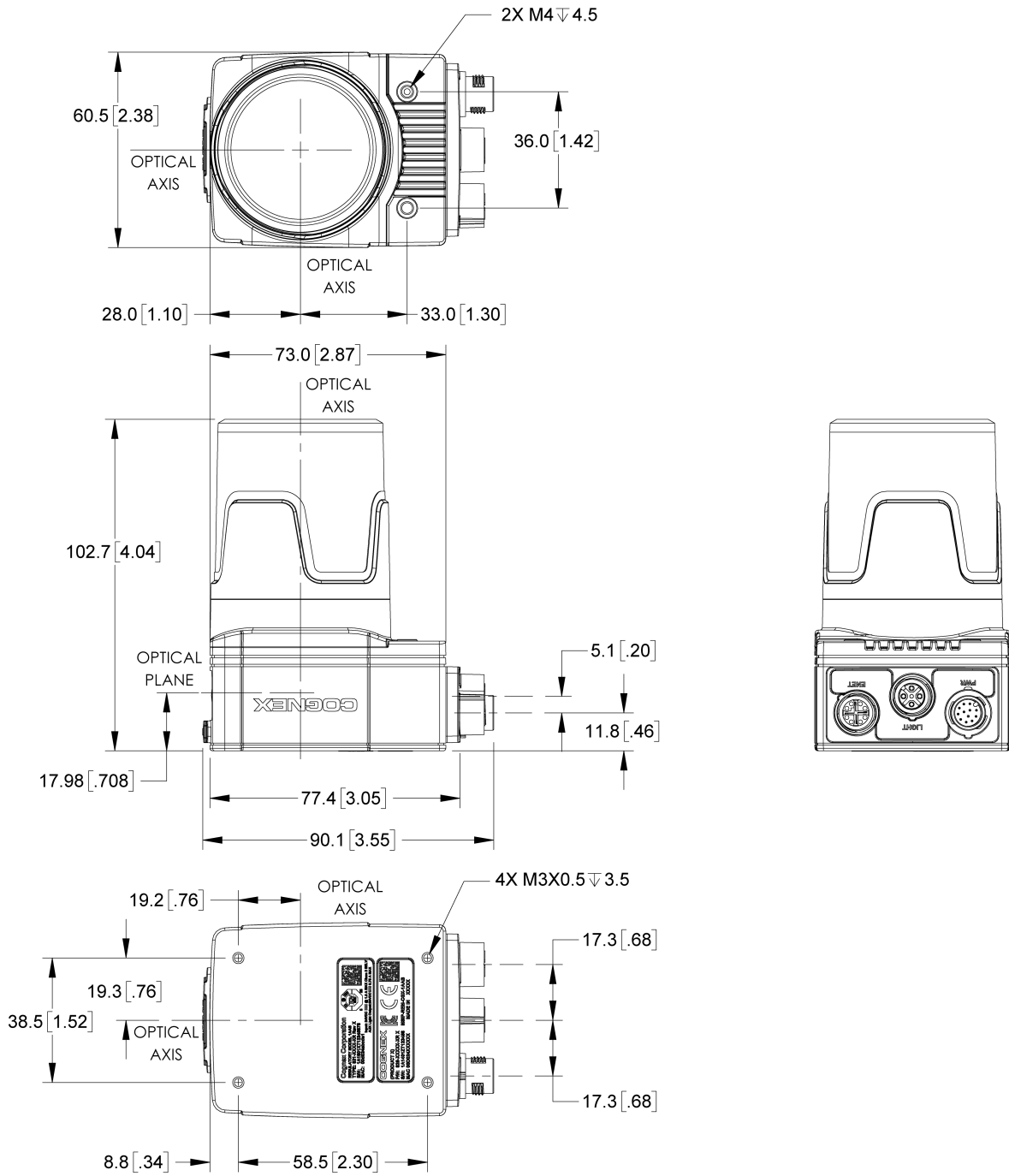

Vision System Dimensions with Illumination and Lens Cover (ISLM-7000-WHI)

Note:



- All dimensions are in millimeters [inches] and are for reference purposes only.
- All specifications are for reference purpose only and may be changed without notice.

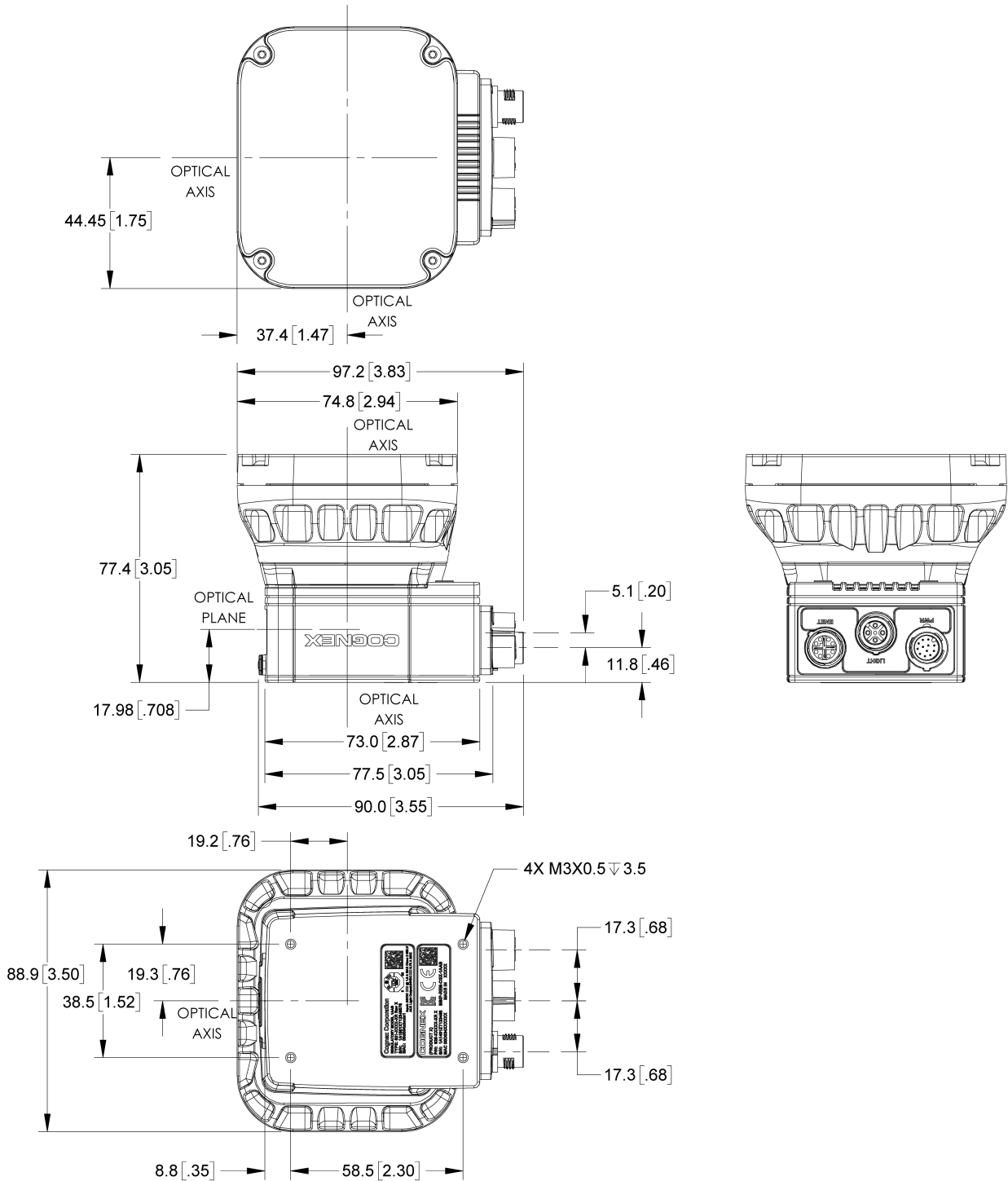

Mounting Bracket Dimensions (ISB-7000-7K)

Note:

- All dimensions are in millimeters [inches] and are for reference purposes only.
- All specifications are for reference purpose only and may be changed without notice.

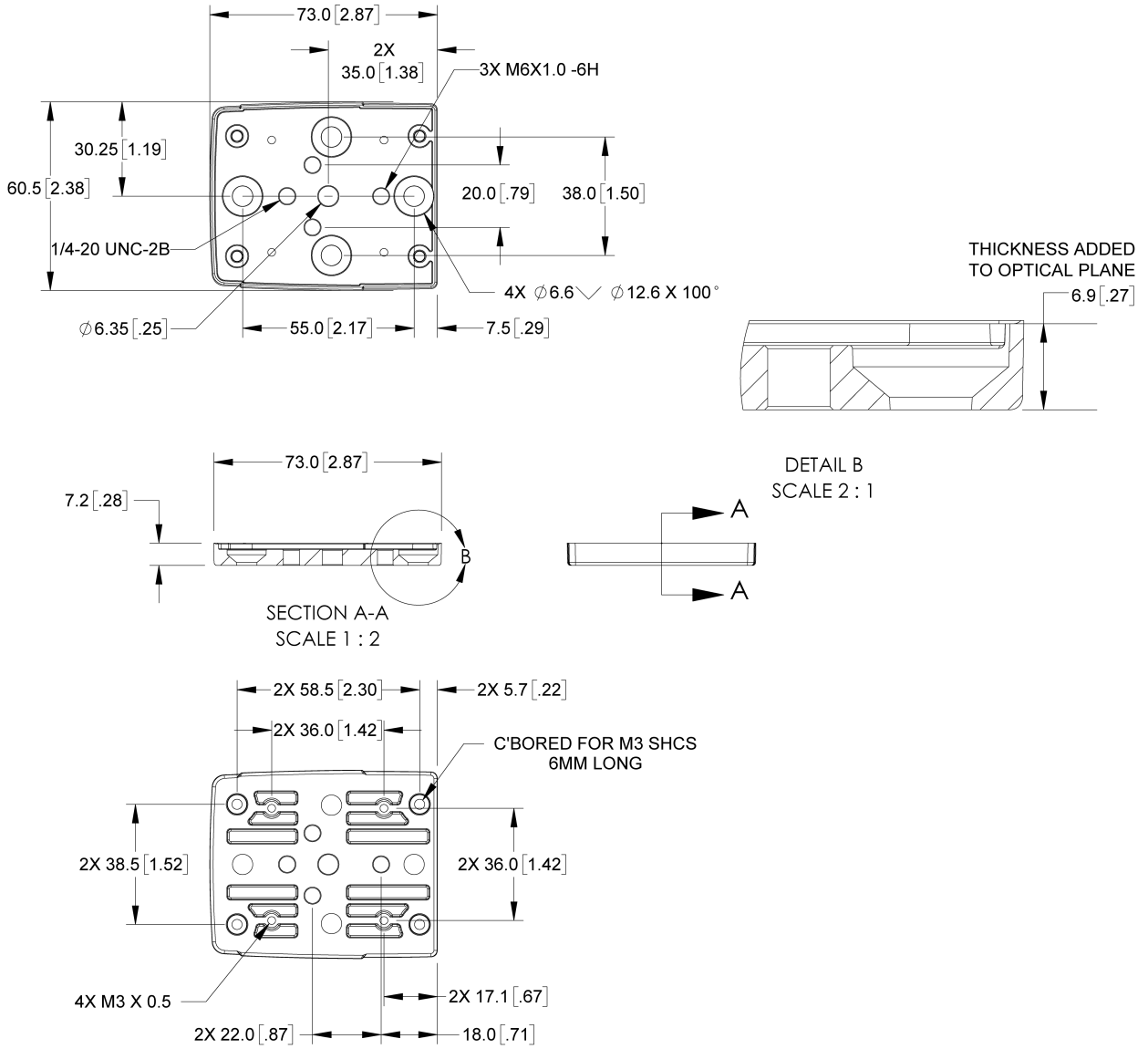

Mounting Bracket Dimensions (ISB-7000-5K)

Note:

- All dimensions are in millimeters [inches] and are for reference purposes only.
- All specifications are for reference purpose only and may be changed without notice.

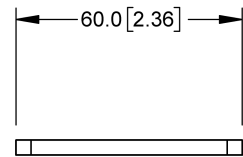
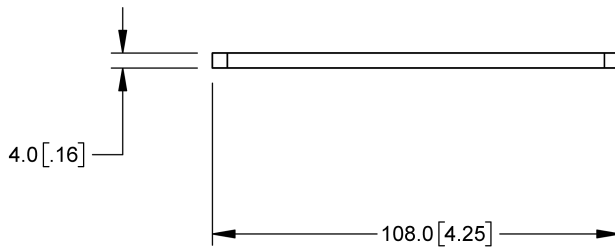
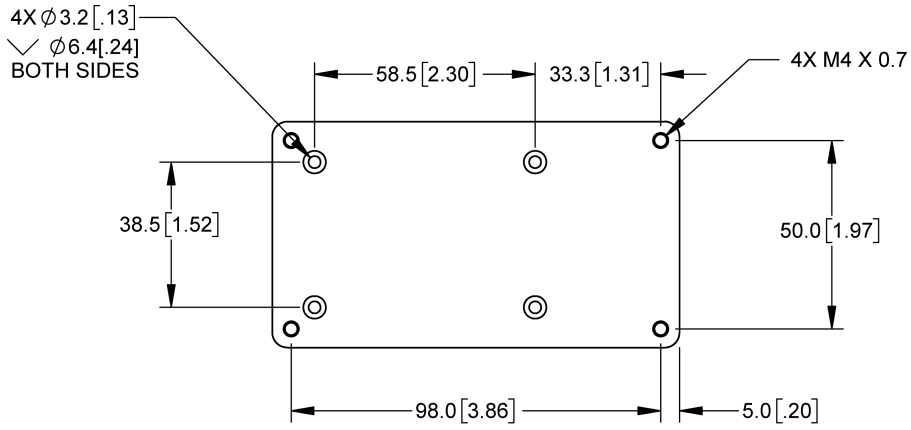

Vision System C-Mount Lens Clearance Dimensions

Note:

- All dimensions are in millimeters [inches] and are for reference purposes only.
- All specifications are for reference purpose only and may be changed without notice.

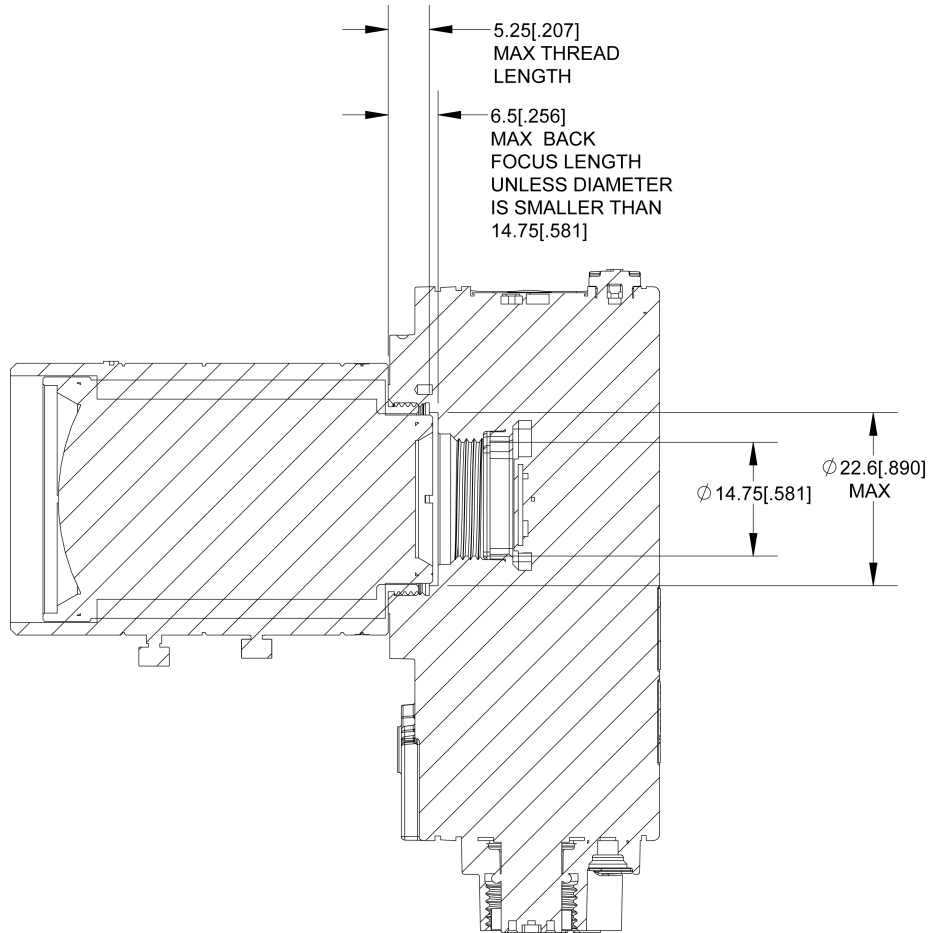

Cleaning/Maintenance

Clean the Vision System Housing

To clean the outside of the vision system housing, use a small amount of mild detergent cleaner or isopropyl alcohol on a cleaning cloth. Do not pour the cleaner directly onto the vision system housing.

 **CAUTION:** Do not attempt to clean any In-Sight product with harsh or corrosive solvents, including lye, methyl ethyl ketone (MEK) or gasoline.

Clean the Vision System Image Sensor Window

To remove dust from the outside of the image sensor window, use a pressurized air duster. The air must be free of oil, moisture or other contaminants that could remain on the glass and possibly degrade the image. Do not touch the glass window. If oil/smudges still remain, clean the window with a cotton bud using alcohol (ethyl, methyl or isopropyl). Do not pour the alcohol directly on the window.

