

# MOSAIC

## MODULAR SAFETY INTEGRATED CONTROLLER

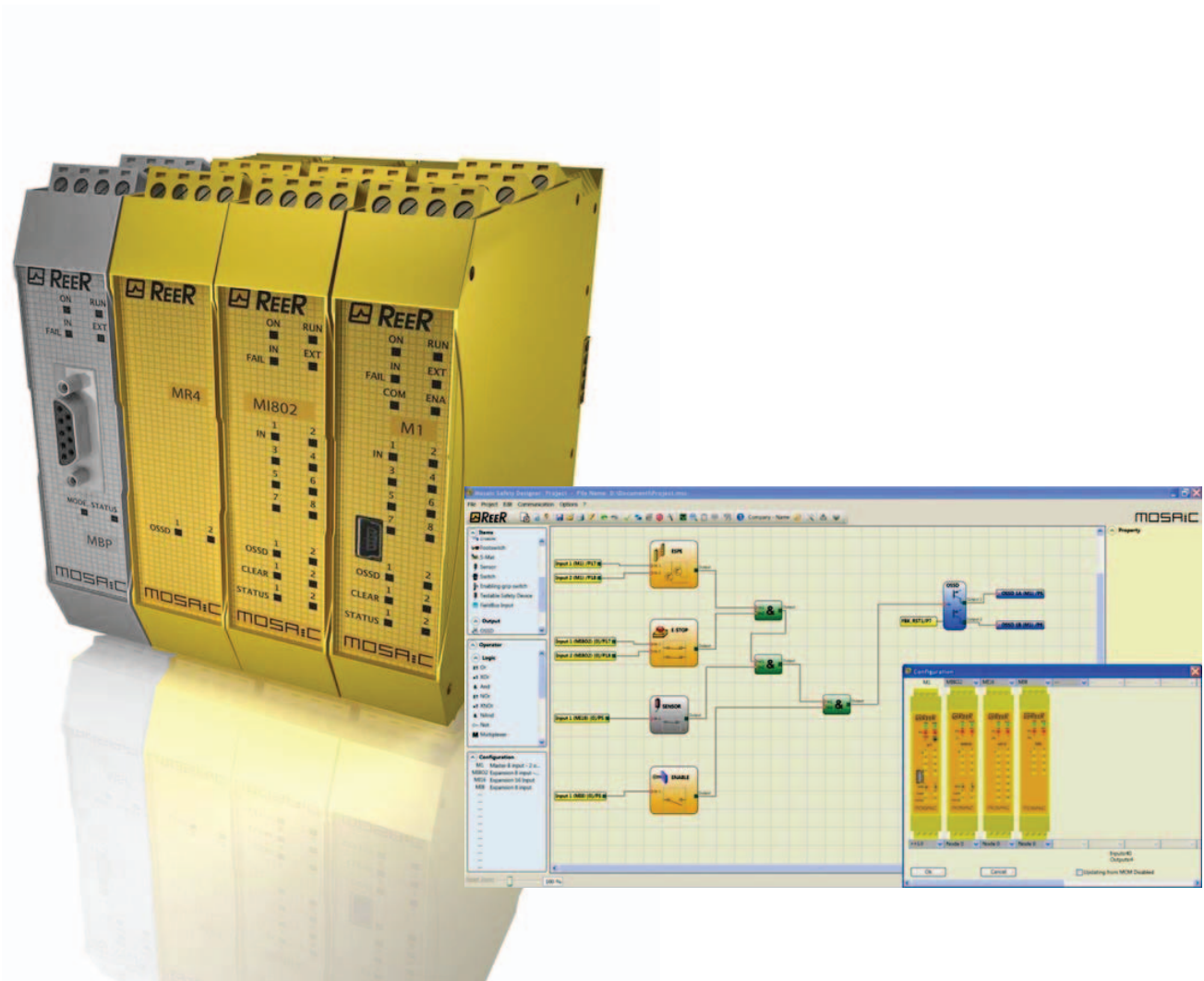

(Copy of the original instructions)

### Installation and use



32 via Carcano  
10153 Torino Italia  
www.reer.it



**Dichiarazione CE di conformità**  
*EC declaration of conformity*

Torino, 18/01/2013

REER SpA  
via Carcano 32  
10153 – Torino  
Italy

**dichiara che il controllore integrato MOSAIC costituisce un dispositivo di sicurezza realizzato in conformità alle seguenti Direttive Europee:**

*declares that the integrated controller MOSAIC is a safety device complying with the following European Directives:*

2006/42/CE	"Direttiva Macchine" "Machine Directive"
2004/108/CE	"Direttiva Compatibilità Elettromagnetica" "Electromagnetic Compatibility Directive"
2006/95/CE	"Direttiva Bassa Tensione" "Low Voltage Directive"

**ed è conforme alle seguenti norme:**  
*and complies with the following standards:*

CEI EN 61131-2 (07/2007)	Controllori programmabili - Parte 2: Specifiche e prove delle apparecchiature. <i>Programmable controllers - Part 2. Equipment requirements and tests.</i>
ISO 13849-1 (06/2008)	Sicurezza del macchinario: Parti dei sistemi di comando legate alla sicurezza. Parte 1: Principi generali per la progettazione. <i>Safety of machinery: - Safety-related parts of control systems - Part 1: General principles for design.</i>
EN 61496-1 (11/2005)	Sicurezza del macchinario: Dispositivi Elettrosensibili di protezione, Parte 1: Requisiti generali e tests. <i>Safety of machinery : Electro sensitive protective equipment, Part 1: General requirements and tests.</i>
IEC 61508-1 (1998)	Sicurezza funzionale di impianti elettrici/elettronici/programmabili legati alla sicurezza: Requisiti generali. <i>Functional safety of electrical/electronic programmable electronic safety related systems: General requirements.</i>
IEC 61508-2 (2000)	Sicurezza funzionale di impianti elettrici/elettronici/programmabili legati alla sicurezza: Requisiti per impianti elettrici/elettronici/programmabili legati alla sicurezza. <i>Functional safety of electrical/electronic/programmable electronic safety related systems: Requirements for electrical/electronic/programmable electronic safety-related systems.</i>
IEC 61508-3 (1998)	Sicurezza funzionale di impianti elettrici/elettronici/programmabili legati alla sicurezza: Requisiti Software. <i>Functional safety of electrical/electronic programmable electronic safety related systems: Software requirements.</i>
IEC 61784-3 (2008)	Reti di comunicazione industriali - Profili - Parte 3: Sicurezza funzionale dei bus di campo - Norme generali e profilo definizioni. <i>Industrial communication networks - Profiles - Part 3: Functional safety fieldbuses - General rules and profile definitions.</i>
IEC 62061 (01/2005)	Sicurezza del macchinario. Sicurezza funzionale dei sistemi di comando e controllo elettrici, elettronici e programmabili correlati alla sicurezza. <i>Safety of machinery - Functional safety of safety-related electrical, electronic and programmable electronic control systems.</i>

**raggiungendo il livello di sicurezza pari a: SIL 3 / SILCL 3 / PL e/ Cat. 4 / Tipo 4 (v. standard corrispondenti)**  
*reaching a safety level corresponding to : SIL 3 / SILCL 3 / PL e / Cat. 4 / Type 4 (see related standards)*

**ed è identico all'esemplare esaminato ed approvato con esame di tipo CE da:**  
*and is identical to the specimen examined and approved with a CE - type approval by:*  
TÜV SÜD Rail GmbH – Ridlerstrasse 65 – D-80339 – Muenchen – Germany

Carlo Pautasso  
Direttore Tecnico  
Technical Director

Simone Scaravelli  
Amministratore Delegato  
Managing director

# MODULAR SAFETY INTEGRATED CONTROLLER

## CONTENTS

<b>INTRODUCTION .....</b>	<b>7</b>
Contents of this handbook .....	7
Important safety instructions.....	7
Abbreviations and symbols.....	8
Applicable standards .....	8
<b>OVERVIEW .....</b>	<b>9</b>
<b>PRODUCT COMPOSITION .....</b>	<b>11</b>
<b>INSTALLATION.....</b>	<b>12</b>
Mechanical fastening .....	12
Calculation of safety distance of an ESPE connected to MOSAIC .....	13
Electrical connections .....	13
Instructions concerning connection cables. ....	14
USB input .....	15
MOSAIC Configuration Memory (MCM).....	15
MULTIPLE LOAD function.....	15
RESTORE function.....	15
ENCODER CONNECTIONS WITH RJ45 CONNECTOR (MV1, MV2) .....	20
Example of connection of Mosaic to the machine control system.....	22
CHECKLIST AFTER INSTALLATION .....	22
<b>OPERATING DIAGRAM.....</b>	<b>23</b>
<b>SIGNALS .....</b>	<b>24</b>
<b>INPUTS .....</b>	<b>24</b>
MASTER ENABLE .....	24
NODE SEL .....	24
RESTART_FBK .....	25
<b>OUTPUTS .....</b>	<b>26</b>
OUT STATUS.....	26
OUT TEST .....	26
OSSD (M1, MI8O2) .....	26
OSSD (MO2, MO4) .....	26
SAFETY RELAYS (MR2, MR4).....	27
Characteristics of the output circuit.....	27
MR2/MR4 internal contacts diagram.....	27
Example of MR2 module connection with static OSSD outputs of a module M1 .....	28
Switching operation timing diagram. ....	28
<b>TECHNICAL FEATURES.....</b>	<b>29</b>
<b>GENERAL SYSTEM CHARACTERISTICS .....</b>	<b>29</b>
Safety level parameters .....	29
General data.....	29
Enclosure .....	30
M1 module.....	30
MI8O2 module .....	30
MI8 - MI16 modules .....	31
MI12T8 module.....	31

MO2 - MO4 modules .....	31
MR2 - MR4 modules .....	31
MV0 - MV1 - MV2 modules .....	32
MOR4 - MOR4S8 module.....	32
MECHANICAL DIMENSIONS.....	33
SIGNALS .....	34
Master M1 (Figure 10) .....	34
MI8O2 (Figure 11) .....	36
MI8 (Figure 12).....	37
MI12T8 (Figure 14).....	38
MI16 (Figure 14).....	39
MO2 (Figure 15) .....	40
MO4 (Figure 16) .....	41
MOR4 (Figure 17) .....	42
MOR4S8 (Figure 18).....	43
MV1, MV2 (Figure 19).....	44
MR2 (Figure 20) / MR4 (Figure 21).....	45
TROUBLESHOOTING.....	46
Master M1 (Figure 22) .....	46
MI8O2 (Figure 23) .....	47
MI8 (Figure 24).....	48
MI12T8 (Figure 25).....	49
MI16 (Figure 26 - MI16) .....	50
MO2 / MO4 (Figure 27) .....	51
MOR4 (Figure 28) .....	52
MOR4S8 (Figure 29).....	53
MV0, MV1, MV2 (Figure 29).....	54
MOSAIC SAFETY DESIGNER SOFTWARE.....	55
Installing the software .....	55
PC HARDWARE requirements .....	55
PC SOFTWARE requirements .....	55
How to install MSD .....	55
Fundamentals.....	56
Standard tool bar .....	57
Textual tool bar.....	58
Create a new project (configure the MOSAIC system).....	58
EDIT CONFIGURATION (composition of the various modules).....	59
Change user parameters .....	59
OBJECTS - OPERATOR - CONFIGURATION tool bars.....	60
Creating the diagram .....	61
Use of mouse right button .....	62
Example of a project .....	63
Project validation .....	63
Project report.....	64
Connect to Mosaic.....	65
Sending the configuration to the MOSAIC.....	65
Download a configuration file (project) from Mosaic M1 .....	65
Configuration LOG .....	65
System composition .....	66
Disconnecting System .....	66
MONITOR (I/O status in real time - textual) .....	67

MONITOR (I/O status in real time - textual - graphic).....	67
Password protection.....	68
Level 1 password.....	68
Level 2 password.....	68
Password Change.....	68
TESTING the system.....	69
OBJECT FUNCTION BLOCKS.....	70
OUTPUT OBJECTS.....	70
OSSD (safety outputs).....	70
STATUS (signal output).....	70
FIELDBUS PROBE.....	70
RELAY.....	71
INPUT OBJECTS.....	72
E-STOP (emergency stop).....	72
E-GATE (safety gate device).....	73
SINGLE E-GATE (safety gate device).....	75
LOCK FEEDBACK.....	76
ENABLE (enable key).....	77
ESPE (optoelectronic safety light curtain / laser scanner).....	78
FOOTSWITCH (safety pedal).....	79
MOD-SEL (safety selector).....	80
PHOTOCELL (safety photocell).....	81
TWO-HAND (bimanual control).....	82
SENSOR.....	83
S-MAT (safety mat).....	84
SWITCH.....	85
ENABLING GRIP SWITCH.....	86
TESTABLE SAFETY DEVICE.....	87
SOLID STATE DEVICE.....	89
FIELDBUS INPUT.....	90
LLO-LL1.....	90
COMMENTS.....	90
TITLE.....	90
SPEED CONTROL TYPE FUNCTION BLOCKS.....	91
SPEED CONTROL.....	91
WINDOW SPEED CONTROL.....	93
STAND STILL.....	95
STAND STILL AND SPEED CONTROL.....	97
OPERATOR FUNCTION BLOCKS.....	99
LOGICAL OPERATORS.....	99
AND.....	99
NAND.....	99
NOT.....	100
OR.....	100
NOR.....	100
XOR.....	101
XNOR.....	101
MULTIPLEXER.....	101
MEMORY OPERATORS.....	102
D FLIP FLOP (max number = 16).....	102
SR FLIP FLOP.....	103
USER RESTART MANUAL (max number = 16 with RESTART MONITORED).....	103

USER RESTART MONITORED (max number = 16 with RESTART MANUAL)	103
GUARD LOCK OPERATORS .....	104
GUARD LOCK .....	104
COUNTER OPERATORS .....	106
COUNTER (max number = 16) .....	106
TIMER OPERATORS (max number = 16) .....	106
CLOCKING .....	106
MONOSTABLE .....	107
PASSING MAKE CONTACT .....	108
DELAY .....	109
MUTING OPERATORS (max number = 4) .....	110
"Concurrent" MUTING .....	110
MUTING "L" .....	111
"Sequential" MUTING .....	112
MUTING "T" .....	113
MUTING OVERRIDE (max number = 16) .....	114
MISCELLANEOUS FUNCTION BLOCKS .....	116
SERIAL OUTPUT .....	116
NETWORK .....	117
SPECIAL APPLICATIONS .....	120
Output delay with manual .....	120
MOSAIC FAIL CODES .....	121
ACCESSORIES AND SPARE PARTS .....	122
WARRANTY .....	123

## INTRODUCTION

### Contents of this handbook

This handbook describes how to use the MOSAIC programmable safety module and its expansion units ("SLAVES");











it includes:

- a description of the system
- method of installation
- connections
- signals
- troubleshooting
- use of the configuration SW

### Important safety instructions

 This safety alert symbol indicates a potential **personal safety hazard**. Failure to comply with instructions bearing this symbol could pose a very serious risk to personnel.

 This symbol indicates an important instruction.

-  The MOSAIC is built to the following safety levels: SIL 3, SILCL 3, PL e, Cat. 4, Type 4 in accordance with the applicable standards. However, the definitive SIL and PL of the application will depend on the number of safety components, their parameters and the connections that are made, as per the risk analysis.
-  Read the "Applicable Standards" section carefully.
-  Perform an in-depth risk analysis to determine the appropriate safety level for your specific application, on the basis of all the applicable standards.
-  Programming/configuration of the Mosaic is the sole responsibility of the installer or user.
-  The device must be programmed/configured in accordance with the application-specific risk analysis and all the applicable standards.
-  Once you have programmed/configured and installed the Mosaic and all the relative devices, run a complete application safety test (see "TESTING the system", page 69).
-  Always test the complete system whenever new safety components are added (see the "TESTING the system" section, page 69).
-  Reer is not responsible for these operations or any risks in connection therewith.
-  Reference should be made to the handbooks and the relative product and/or application standards to ensure correct use of devices connected to the Mosaic within the specific application.
-  The ambient temperature in the place where the system is installed must be compatible with the operating temperature parameters stated on the product label and in the specifications.
-  For all matters concerning safety, if necessary, contact your country's competent safety authorities or the competent trade association.

## Abbreviations and symbols

MCM =	MOSAIC Configuration Memory: <i>memory chip for MOSAIC M1 (accessory)</i>
MSC =	MOSAIC Safety Communication: <i>proprietary bus for expansion units</i>
MSD =	MOSAIC Safety Designer: <i>MOSAIC configuration SW running in Windows</i>
OSSD =	Output Signal Switching Device: <i>solid state safety output</i>
MTTF <sub>d</sub> =	Mean Time to Dangerous Failure
PL =	Performance Level
PFH <sub>d</sub> =	Probability of a dangerous failure per Hour
SIL =	Safety Integrity Level
SILCL =	Safety Integrity Level Claim Limit
SW =	Software

## Applicable standards

MOSAIC complies with the following European Directives:

- 2006/42/EC "Machinery Directive"
- 2004/108/EC "Electromagnetic Compatibility Directive"
- 2006/95/EC "Low Voltage Directive"

and is built to the following standards:

CEI EN 61131- 2	Programmable controllers, part 2: Equipment requirements and tests
ISO 13489- 1	Safety of machinery: Safety related parts of control systems. General principles for design
EN 61496- 1	Safety of machinery: Electro-sensitive protective equipment. Part 1: General requirements and tests.
IEC 61508- 1	Functional safety of electrical/electronic/programmable electronic safety-related systems: General requirements.
IEC 61508- 2	Functional safety of electrical/electronic/programmable electronic safety-related systems: Requirements for electrical/electronic/programmable electronic safety-related systems.
IEC 61508- 3	Functional safety of electrical/electronic/programmable electronic safety-related systems: Software requirements.
IEC 61784- 3	Digital data communication for measurement and control: Functional safety fieldbuses.
IEC 62061	Safety of machinery. Functional safety of safety-related electrical, electronic and programmable electronic control systems

Table 1



## OVERVIEW

MOSAIC is a modular safety controller. It consists of a master unit (**M1**), which can be configured using the MSD graphic interface, and a number of expansion units connected to the M1 via the proprietary MSC bus.

The M1 can also be used as a stand-alone device. It has 8 safety inputs and 2 independent programmable dual channel outputs.

➔ The following expansions are available: I/O expansions (**MI802**), input only expansions (**MI8**, **MI12T8**, **MI16**, **MV0**, **MV1** and **MV2**), output only expansions (**MO2** and **MO4**), guided contact safety relay output modules (**MR2**, **MR4**, **MOR4** and **MOR4S8**) and diagnostic connections to the main fieldbuses: **MBP** (PROFIBUS), **MBC** (CanOpen), **MBD** (DeviceNet), **MBEI** (ETHERNET/IP), **MBEP** (Profinet), **MBEC** (ETHERCAT).

MOSAIC is capable of monitoring the following safety sensors and commands:

optoelectronic sensors (safety light curtains, scanners, safety photocells), mechanical switches, safety mats, emergency stops, two-hand controls, all managed by a single flexible and expandable device.

The system must consist of just one Master M1 and a number of electronic expansions that can range from 0 to a maximum of 14, not more than 4 of which of the same type. There is no limit to the number of relay modules that can be installed.

With 14 expansions, the system can have up to 128 inputs, 16 dual channel safety outputs and 16 status outputs. The MASTER and its SLAVE units communicate via the 5-way MSC bus (Reer proprietary bus), physically arranged on the rear panel of each unit.

Furthermore 8 inputs and 16 outputs probe controllable (by Fieldbus) are available.

With the **MI8**, **MI16** and **MI12T8** Mosaic expansion units, the number of inputs in the system can be increased to allow more external devices to be connected. The **MI12T8** also provides 8 OUT\_TEST outputs.

The **MO2** and **MO4** Mosaic expansion units provide the system, respectively, with 2 and 4 OSSD (Output Signal Switching Device) pairs for controlling devices connected downstream of the **MOSAIC**.

The **MI802** has 8 inputs and 2 OSSD outputs.

The **MR2** and **MR4** Mosaic expansion units provide the system with 2 and 4 N.O. guided contact safety relay outputs, respectively, with the related external relay feedback (N.C. contact).

The expansion units in the **MB** series permit connection to the most commonly used industrial fieldbus systems for diagnostics and data transmission. The **MBEI**, **MBEP** and **MBEC** also have an ethernet connection. The **MBU** permits connection to devices with a USB port.

The **MCT1** and **MCT2 Mosaic** units are used to connect the M1 to other slave units installed at a distance (< 50 m). Two MCT units installed at the required distance can be connected using a shielded cable (ReeR MC25, MC50 or other cable with the characteristics set out in the cable data sheet).

The **MV0**, **MV1** and **MV2** Mosaic expansion units can be used to control the following (up to PLe):

- Zero speed, Max. speed, Speed range;
- Direction of movement, rotation/translation;

Up to 4 speed thresholds can be set for each logic output (axis).

Each unit incorporates two logic outputs that can be configured using the MSD software and is thus capable of controlling up to two independent axes.

The **MOR4** and **MOR4S8** are safety units provided with 4 independent safety relay outputs and the corresponding 4 inputs for the external feedback contacts (EDM).

There are two possible output settings (configured using the MSD configuration software).

- Two pairs of connection contacts (2 N.O. contacts per output with 2 corresponding feedback inputs).
- Four independent single connection contacts (1 N.O. contact per output with 1 corresponding feedback input).

Only the MOR4S8 unit has 8 programmable signal outputs.

The MSD software is capable of creating complex logics, using logical operators and safety functions such as muting, timer, counters, etc.

All this is performed through an easy and intuitive graphic interface.

The configuration performed on the PC is sent to the M1 via USB connection; the file resides in the M1 and can also be saved on the proprietary MCM memory chip (accessory). The configuration can therefore quickly be copied to another M1 unit.

➔ The MOSAIC system is certified to the maximum safety level envisaged by the applicable industrial safety standards (SIL 3, SILCL 3, PL e, Cat. 4).

## PRODUCT COMPOSITION

The MOSAIC M1 is supplied with:

- CD-ROM containing the free MSD SW, this PDF multi-language handbook and other product literature.
- Multi-language installation sheet.

➔ NB: the rear panel MSC connector and MCM memory can be ordered separately as accessories.

The expansion units are supplied with:

- Multilingual Installation sheet.
- Rear panel MSC connector (not present in the MR2 and MR4 which are connected via terminal blocks only).

➔ NB: to install an expansion unit (excluding relays) you will need the MSC connector supplied with the unit plus another MSC for the connection to the M1. This can be ordered separately as an accessory.

# INSTALLATION

## Mechanical fastening

Fix the MOSAIC system units to a 35mm DIN rail as follows:

1. Connect the same number of "MSC" 5-pole rear panel connectors as the number of units to be installed.
2. Fix the train of connectors thus obtained to the Omega DIN 35mm (EN 5022) rail (hooking them at the top first).
3. Fasten the units to the rail, arranging the contacts on the base of the unit on the respective connector. Press the unit gently until you feel it snap into place.
4. To remove a unit, use a screwdriver to pull down the locking latch on the back of the unit; then lift the unit upwards and pull.

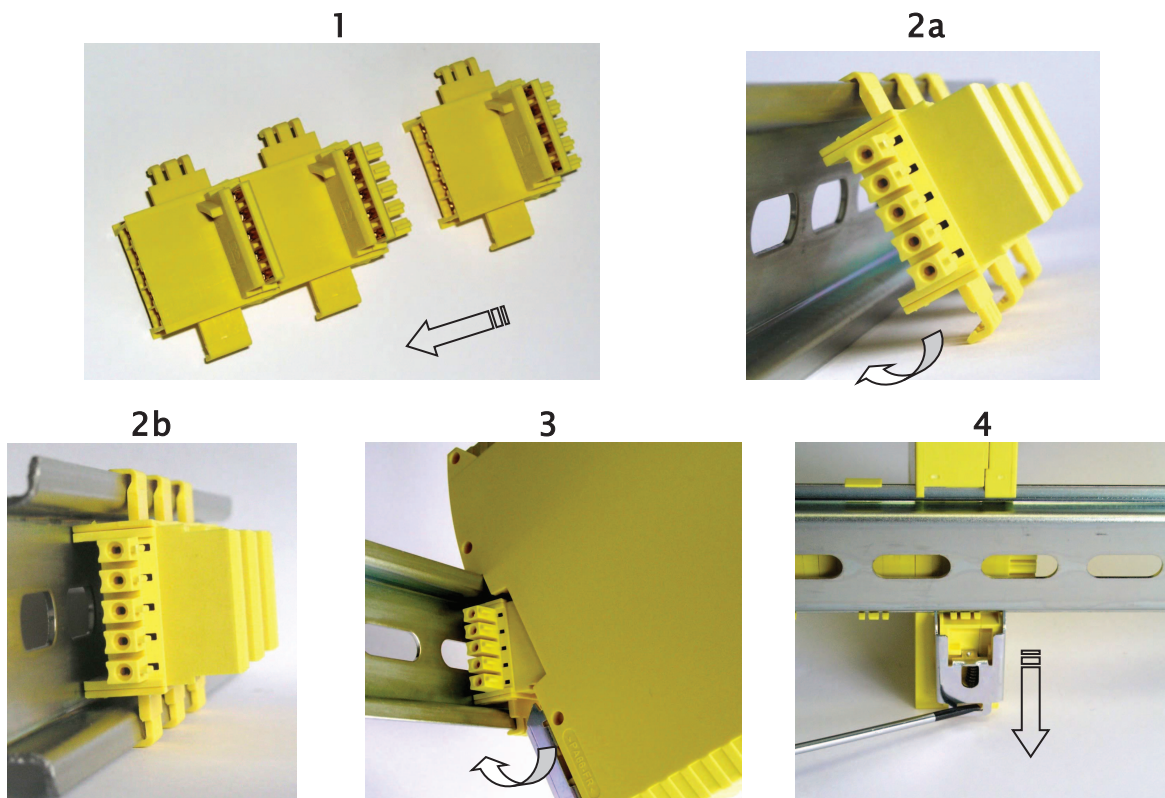

Figure 1

## Calculation of safety distance of an ESPE connected to MOSAIC

Any Electro-sensitive Protective Equipment device connected to MOSAIC, must be positioned at a distance equal to or greater than the minimum safety distance  $S$  so that the dangerous point can be reached only after stopping the dangerous movement of the machine.

- The european standard:
  - ISO 13855:2010- (EN 999:2008) Safety of machinery - *Positioning of safeguards with respect to the approach speeds of parts of the human body.*<sup>1</sup> provides the elements to calculate the proper safety distance.
- Carefully read the installation manual of each device for specific information on the correct positioning.
- Remember that the total response time depends on:  
 MOSAIC response time + ESPE response time + response time of the machine (i.e. the time taken by the machine to stop the dangerous movement from the moment in which the stop signal is transmitted).

## Electrical connections

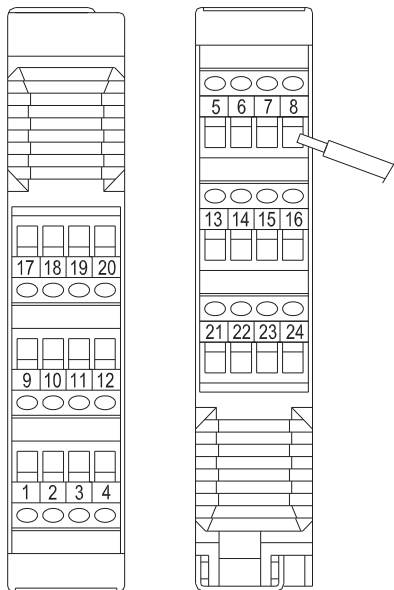

The MOSAIC system units are provided with terminal blocks for the electrical connections. Each unit can have 8, 16 or 24 terminals. Each unit also has a rear panel plug-in connector (for communication with the master and with the other expansion units).

The MR2 and MR4 are connected via terminal blocks only.

➔ Terminal tightening torque: 5÷7lb-in (0,6÷0,7 Nm).

- Install safety units in an enclosure with a protection class of at least IP54.
- Connect the module when it is not powered.
- The supply voltage to the units must be 24Vdc  $\pm 20\%$  (PELV, in compliance with the standard EN 60204-1 (Chapter 6.4)).
- Do not use the MOSAIC to supply external devices.
- The same ground connection (0VDC) must be used for all system components.

<sup>1</sup> "Describe the methods that designers can use to calculate the minimum safety distance from a specific dangerous point for the safety devices, particularly Electro-sensitive devices (eg. light curtains), safety-mats or pressure sensitive floors and bimanual control. It contains a rule to determine the placement of safety devices based on approach speed and the stopping time of the machine, which can reasonably be extrapolated so that it also includes the interlocking guards without guard locking."

## Instructions concerning connection cables.

- ➔ Wire size range: AWG 12÷30, (solid/stranded) (UL).
- ➔ Use 60/75°C copper (Cu) conductor only.
- ➔ We recommend the use of separate power supplies for the safety module and for other electrical power equipment (electric motors, inverters, frequency converters) or other sources of disturbance.
- ➔ Cables used for connections of longer than 50m must have a cross-section of at least 1mm<sup>2</sup> (AWG16).

Connections of each single MOSAIC system unit are listed in the table below:

Master M1				
TERMINAL	SIGNAL	TYPE	DESCRIPTION	OPERATION
1	24VDC	-	24VDC power supply	-
2	MASTER_ENABLE1	Input	Master Enable 1	Input (" <i>type B</i> " according to EN 61131-2)
3	MASTER_ENABLE2	Input	Master Enable 2	Input (" <i>type B</i> " according to EN 61131-2)
4	GND	-	0VDC power supply	-
5	OSSD1_A	Output	Static output 1	PNP active high
6	OSSD1_B	Output		PNP active high
7	RESTART_FBK1	Input	Feedback/Restart 1	Input according to EN 61131-2
8	OUT_STATUS1	Output	Programmable digital output	PNP active high
9	OSSD2_A	Output	Static output 2	PNP active high
10	OSSD2_B	Output		PNP active high
11	RESTART_FBK2	Input	Feedback/Restart 2	Input according to EN 61131-2
12	OUT_STATUS2	Output	Programmable digital output	PNP active high
13	OUT_TEST1	Output	Short circuit detected output	PNP active high
14	OUT_TEST2	Output	Short circuit detected output	PNP active high
15	OUT_TEST3	Output	Short circuit detected output	PNP active high
16	OUT_TEST4	Output	Short circuit detected output	PNP active high
17	INPUT1	Input	Digital input 1	Input according to EN 61131-2
18	INPUT2	Input	Digital input 2	Input according to EN 61131-2
19	INPUT3	Input	Digital input 3	Input according to EN 61131-2
20	INPUT4	Input	Digital input 4	Input according to EN 61131-2
21	INPUT5	Input	Digital input 5	Input according to EN 61131-2
22	INPUT6	Input	Digital input 6	Input according to EN 61131-2
23	INPUT7	Input	Digital input 7	Input according to EN 61131-2
24	INPUT8	Input	Digital input 8	Input according to EN 61131-2

## USB input

The MOSAIC master M1 includes a USB 2.0 connector for connection to a Personal Computer where the **MSD** (MOSAIC Safety Designer) configuration SW resides.

A USB cable of the correct size is available as an accessory (CSU).



Figure 2 - USB 2.0 front panel connector

## TECHNICAL DATA LABEL

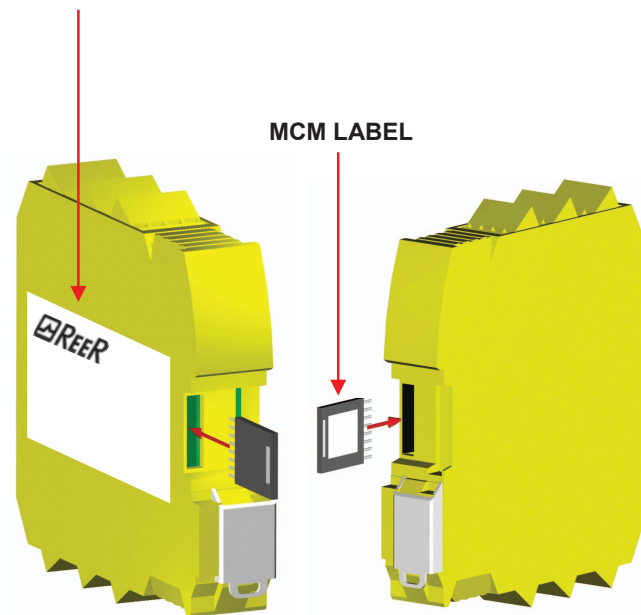

Figure 3 - MCM

## MOSAIC Configuration Memory (MCM)

A backup memory, called **MCM** (optional) can be installed in the MOSAIC master M1 and used to save the SW configuration parameters.

The MCM is written **each time** a new project is sent from the PC to the M1.

➔ Always switch the M1 off before logging on to/logging off from the MCM.

Insert the card in the **slot in the rear panel of the M1** (in the direction shown in Figure 3 - MCM).

## MULTIPLE LOAD function

To perform the configuration of several M1 modules without using a PC and the USB connector, you can save the desired configuration on a single MCM and then use it to download data on the modules M1 to be configured.

**⚠** If the file contained in the MCM is not identical to the one contained in M1, an overwrite operation that will permanently delete the configuration data contained in M1 will be performed.

**WARNING: ALL DATA PREVIOUSLY CONTAINED IN M1 WILL BE LOST.**

## RESTORE function

If the M1 unit is damaged, you can replace it with a new one; having already saved all the configurations on the MCM, all you need to do is insert the MCM in the new M1 and switch on the MOSAIC system, that will immediately load the backup configuration. In this way, the work interruptions will be minimized.

➔ The LOAD and RESTORE functions can be disabled via SW. (see Figure 35)

➔ In order to be used, the expansion units must be addressed at the time of installation (see the NODE SEL section).

 Each time MCM is used, carefully check that the chosen configuration is the one that was planned for that particular system. Try again a fully functional test of the system composed of Mosaic plus all devices connected to it (see the TESTING the system section).

MI8O2				
TERMINAL	SIGNAL	TYPE	DESCRIPTION	OPERATION
1	24VDC	-	24VDC power supply	-
2	NODE_SELO	Input	Node selection	Input ("type B" according to EN 61131-2)
3	NODE_SEL1	Input		Input ("type B" according to EN 61131-2)
4	GND	-	0VDC power supply	-
5	OSSD1_A	Output	Static output 1	PNP active high
6	OSSD1_B	Output		PNP active high
7	RESTART_FBK1	Input	Feedback/Restart 1	Input according to EN 61131-2
8	OUT_STATUS1	Output	Programmable digital output	PNP active high
9	OSSD2_A	Output	Static output 2	PNP active high
10	OSSD2_B	Output		PNP active high
11	RESTART_FBK2	Input	Feedback/Restart 2	Input according to EN 61131-2
12	OUT_STATUS2	Output	Programmable digital output	PNP active high
13	OUT_TEST1	Output	Short circuit detected output	PNP active high
14	OUT_TEST2	Output	Short circuit detected output	PNP active high
15	OUT_TEST3	Output	Short circuit detected output	PNP active high
16	OUT_TEST4	Output	Short circuit detected output	PNP active high
17	INPUT1	Input	Digital input 1	Input according to EN 61131-2
18	INPUT2	Input	Digital input 2	Input according to EN 61131-2
19	INPUT3	Input	Digital input 3	Input according to EN 61131-2
20	INPUT4	Input	Digital input 4	Input according to EN 61131-2
21	INPUT5	Input	Digital input 5	Input according to EN 61131-2
22	INPUT6	Input	Digital input 6	Input according to EN 61131-2
23	INPUT7	Input	Digital input 7	Input according to EN 61131-2
24	INPUT8	Input	Digital input 8	Input according to EN 61131-2

Table 2



MI8				
TERMINAL	SIGNAL	TYPE	DESCRIPTION	OPERATION
1	24VDC	-	24VDC power supply	-
2	NODE_SELO	Input	Node selection	Input (" <i>type B</i> " according to EN 61131-2)
3	NODE_SEL1	Input		Input (" <i>type B</i> " according to EN 61131-2)
4	GND	-	0VDC power supply	-
5	INPUT1	Input	Digital input 1	Input according to EN 61131-2
6	INPUT2	Input	Digital input 2	Input according to EN 61131-2
7	INPUT3	Input	Digital input 3	Input according to EN 61131-2
8	INPUT4	Input	Digital input 4	Input according to EN 61131-2
9	OUT_TEST1	Output	Short circuit detected output	PNP active high
10	OUT_TEST2	Output	Short circuit detected output	PNP active high
11	OUT_TEST3	Output	Short circuit detected output	PNP active high
12	OUT_TEST4	Output	Short circuit detected output	PNP active high
13	INPUT5	Input	Digital input 5	Input according to EN 61131-2
14	INPUT6	Input	Digital input 6	Input according to EN 61131-2
15	INPUT7	Input	Digital input 7	Input according to EN 61131-2
16	INPUT8	Input	Digital input 8	Input according to EN 61131-2

Table 3

MI12T8				
TERMINAL	SIGNAL	TYPE	DESCRIPTION	OPERATION
1	24VDC	-	24VDC power supply	-
2	NODE_SELO	Input	Node selection	Input (" <i>type B</i> " according to EN 61131-2)
3	NODE_SEL1	Input		Input (" <i>type B</i> " according to EN 61131-2)
4	GND	-	0VDC power supply	-
5	INPUT1	Input	Digital input 1	Input according to EN 61131-2
6	INPUT2	Input	Digital input 2	Input according to EN 61131-2
7	INPUT3	Input	Digital input 3	Input according to EN 61131-2
8	INPUT4	Input	Digital input 4	Input according to EN 61131-2
9	OUT_TEST1	Output	Short circuit detected output	PNP active high
10	OUT_TEST2	Output	Short circuit detected output	PNP active high
11	OUT_TEST3	Output	Short circuit detected output	PNP active high
12	OUT_TEST4	Output	Short circuit detected output	PNP active high
13	INPUT5	Input	Digital input 5	Input according to EN 61131-2
14	INPUT6	Input	Digital input 6	Input according to EN 61131-2
15	INPUT7	Input	Digital input 7	Input according to EN 61131-2
16	INPUT8	Input	Digital input 8	Input according to EN 61131-2
17	OUT_TEST5	Output	Short circuit detected output	PNP active high
18	OUT_TEST6	Output	Short circuit detected output	PNP active high
19	OUT_TEST7	Output	Short circuit detected output	PNP active high
20	OUT_TEST8	Output	Short circuit detected output	PNP active high
21	INPUT9	Input	Digital input 9	Input according to EN 61131-2
22	INPUT10	Input	Digital input 10	Input according to EN 61131-2
23	INPUT11	Input	Digital input 11	Input according to EN 61131-2
24	INPUT12	Input	Digital input 12	Input according to EN 61131-2

Table 4

MI16				
TERMINAL	SIGNAL	TYPE	DESCRIPTION	OPERATION
1	24VDC	-	24VDC power supply	-
2	NODE_SELO	Input	Node selection	Input (" <i>type B</i> " according to EN 61131-2 )
3	NODE_SEL1	Input		Input (" <i>type B</i> " according to EN 61131-2 )
4	GND	-	0VDC power supply	-
5	INPUT1	Input	Digital input 1	Input according to EN 61131-2
6	INPUT2	Input	Digital input 2	Input according to EN 61131-2
7	INPUT3	Input	Digital input 3	Input according to EN 61131-2
8	INPUT4	Input	Digital input 4	Input according to EN 61131-2
9	OUT_TEST1	Output	Short circuit detected output	PNP active high
10	OUT_TEST2	Output	Short circuit detected output	PNP active high
11	OUT_TEST3	Output	Short circuit detected output	PNP active high
12	OUT_TEST4	Output	Short circuit detected output	PNP active high
13	INPUT5	Input	Digital input 5	Input according to EN 61131-2
14	INPUT6	Input	Digital input 6	Input according to EN 61131-2
15	INPUT7	Input	Digital input 7	Input according to EN 61131-2
16	INPUT8	Input	Digital input 8	Input according to EN 61131-2
17	INPUT9	Input	Digital input 9	Input according to EN 61131-2
18	INPUT10	Input	Digital input 10	Input according to EN 61131-2
19	INPUT11	Input	Digital input 11	Input according to EN 61131-2
20	INPUT12	Input	Digital input 12	Input according to EN 61131-2
21	INPUT13	Input	Digital input 13	Input according to EN 61131-2
22	INPUT14	Input	Digital input 14	Input according to EN 61131-2
23	INPUT15	Input	Digital input 15	Input according to EN 61131-2
24	INPUT16	Input	Digital input 16	Input according to EN 61131-2

Table 5

MO4				
TERMINAL	SIGNAL	TYPE	DESCRIPTION	OPERATION
1	24VDC	-	24VDC power supply	-
2	NODE_SELO	Input	Node selection	Input (" <i>type B</i> " according to EN 61131-2 )
3	NODE_SEL1	Input		Input (" <i>type B</i> " according to EN 61131-2 )
4	GND	-	0VDC power supply	-
5	OSSD1_A	Output	Static output 1	PNP active high
6	OSSD1_B	Output		PNP active high
7	RESTART_FBK1	Input	Feedback/Restart 1	Input according to EN 61131-2
8	OUT_STATUS1	Output	Programmable digital output	PNP active high
9	OSSD2_A	Output	Static output 2	PNP active high
10	OSSD2_B	Output		PNP active high
11	RESTART_FBK2	Input	Feedback/Restart 2	Input according to EN 61131-2
12	OUT_STATUS2	Output	Programmable digital output	PNP active high
13	24VDC	-	24VDC power supply	24VDC outputs power supply *
14	24VDC	-	24VDC power supply	-
15	GND	-	0VDC power supply	0VDC outputs *
16	GND	-	0VDC power supply	-
17	OSSD4_A	Output	Static output 4	PNP active high
18	OSSD4_B	Output		PNP active high
19	RESTART_FBK4	Input	Feedback/Restart 4	Input according to EN 61131-2
20	OUT_STATUS4	Output	Programmable digital output	PNP active high
21	OSSD3_A	Output	Static output 3	PNP active high
22	OSSD3_B	Output		PNP active high
23	RESTART_FBK3	Input	Feedback/Restart 3	Input according to EN 61131-2
24	OUT_STATUS3	Output	Programmable digital output	PNP active high

Table 6

MO2				
TERMINAL	SIGNAL	TYPE	DESCRIPTION	OPERATION
1	24VDC	-	24VDC power supply	-
2	NODE_SELO	Input	Node selection	Input (" <i>type B</i> " according to EN 61131-2)
3	NODE_SEL1	Input		Input (" <i>type B</i> " according to EN 61131-2)
4	GND	-	0VDC power supply	-
5	OSSD1_A	Output	Static output 1	PNP active high
6	OSSD1_B	Output		PNP active high
7	RESTART_FBK1	Input	Feedback/Restart 1	Input according to EN 61131-2
8	OUT_STATUS1	Output	Condition of outputs 1A/1B	PNP active high
9	OSSD2_A	Output	Static output 2	PNP active high
10	OSSD2_B	Output		PNP active high
11	RESTART_FBK2	Input	Feedback/Restart 2	Input according to EN 61131-2
12	OUT_STATUS2	Output	Condition of outputs 2A/2B	PNP active high
13	24VDC	-	24VDC power supply	24VDC output power supply *
14	n.c.	-	-	-
15	GND	-	0VDC power supply	0VDC output *
16	n.c.	-	-	-

Table 7

\* This terminal must be connected to the power supply for the unit to work properly.

MR4				
TERMINAL	SIGNAL	TYPE	DESCRIPTION	OPERATION
1	24VDC	-	24VDC power supply	-
4	GND	-	0VDC power supply	-
5	OSSD1_A	Input	Control ZONE 1	PNP active high
6	OSSD1_B	Input		
7	FBK_K1_K2_1	Output	Feedback K1K2 ZONE 1	
9	A_NC1	Output	NC contact ZONE 1	
10	B_NC1	Output		
13	A_NO11	Output	NO1 contact ZONE 1	
14	B_NO11	Output		
15	A_NO12	Output	NO2 contact ZONE 1	
16	B_NO12	Output		
11	A_NC2	Output	NC contact ZONE 2	
12	B_NC2	Output		
17	OSSD2_A	Input	Control ZONE 2	PNP active high
18	OSSD2_B	Input		
19	FBK_K1_K2_2	Output	Feedback K1K2 ZONE 2	
21	A_NO21	Output	NO1 contact ZONE 2	
22	B_NO21	Output		
23	A_NO22	Output	NO2 contact ZONE 2	
24	B_NO22	Output		

Table 8

MR2				
TERMINAL	SIGNAL	TYPE	DESCRIPTION	OPERATION
1	24VDC	-	24VDC power supply	-
4	GND	-	0VDC power supply	-
5	OSSD1_A	Input	Control ZONE 1	PNP active high
6	OSSD1_B	Input		
7	FBK_K1_K2_1	Output	Feedback K1K2 ZONE 1	
9	A_NC1	Output	NC contact ZONE 1	
10	B_NC1	Output		
13	A_NO11	Output	NO1 contact ZONE 1	
14	B_NO11	Output		
15	A_NO12	Output	NO2 contact ZONE 1	
16	B_NO12	Output		

Table 9

MV0 - MV1 - MV2				
TERMINAL	SIGNAL	TYPE	DESCRIPTION	OPERATION
1	24VDC	-	24VDC power supply	-
2	NODE_SEL0	Input	Node selection	Input (" <i>type B</i> " according to EN 61131-2)
3	NODE_SEL1	Input		Input (" <i>type B</i> " according to EN 61131-2)
4	GND	-	0VDC power supply	-
5	PROX11_24V	Output	PROXIMITY 1 connections	Power supply 24VDC to PROX11
6	PROX11_REF	Output		Power supply 0VDC to PROX11
7	PROX11 IN1 (3 WIRES)	Input		PROX11 NO input
8	PROX11 IN2 (4 WIRES)	Input		PROX11 NC input
9	PROX12_24V	Output	PROXIMITY 2 connections	Power supply 24VDC to PROX12
10	PROX12_REF	Output		Power supply 0VDC to PROX12
11	PROX12 IN1 (3 WIRES)	Input		PROX12 NO input
12	PROX12 IN2 (4 WIRES)	Input		PROX12 NC input
13	N.C.	-	Not connected	-
14	N.C.	-		-
15	N.C.	-		-
16	N.C.	-		-

Table 10

## ENCODER CONNECTIONS WITH RJ45 CONNECTOR (MV1, MV2)

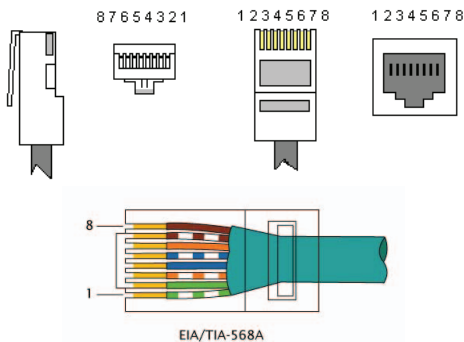

PIN	MS-VT	MS-VH	MS-VS
1	5VDC	N.C.	N.C.
2	EXT_OV	EXT_OV	EXT_OV
3	N.C.	N.C.	N.C.
4	A	A	A
5	$\bar{A}$	$\bar{A}$	$\bar{A}$
6	N.C.	N.C.	N.C.
7	B	B	B
8	B	B	B

MOR4				
TERMINAL	SIGNAL	TYPE	DESCRIPTION	OPERATION
1	24VDC	-	24VDC power supply	-
2	NODE_SEL1	Input	Node selection	Input (" <i>type B</i> " according to EN 61131-2)
3	NODE_SEL2	Input		Input (" <i>type B</i> " according to EN 61131-2)
4	0VDC	-	0VDC power supply	-
5	REST_FBK1	Input	Feedback/Restart 1	Input (secondo EN 61131-2)
6	REST_FBK2	Input	Feedback/Restart 2	Input (secondo EN 61131-2)
7	REST_FBK3	Input	Feedback/Restart 3	Input (secondo EN 61131-2)
8	REST_FBK4	Input	Feedback/Restart 4	Input (secondo EN 61131-2)
9	A_NO1	Output	N.O. contact Channel 1	
10	B_NO1	Output		
11	A_NO2	Output	N.O. contact Channel 2	
12	B_NO2	Output		
13	A_NO3	Output	N.O. contact Channel 3	
14	B_NO3	Output		
15	A_NO4	Output	N.O. contact Channel 4	
16	B_NO4	Output		

Table 11

MOR4S8				
TERMINAL	SIGNAL	TYPE	DESCRIPTION	OPERATION
1	24VDC	-	24VDC power supply	-
2	NODE_SEL1	Input	Node selection	Input (" <i>type B</i> " according to EN 61131-2)
3	NODE_SEL2	Input		Input (" <i>type B</i> " according to EN 61131-2)
4	0VDC	-	0VDC power supply	-
5	REST_FBK1	Input	Feedback/Restart 1	Input (secondo EN 61131-2)
6	REST_FBK2	Input	Feedback/Restart 2	Input (secondo EN 61131-2)
7	REST_FBK3	Input	Feedback/Restart 3	Input (secondo EN 61131-2)
8	REST_FBK4	Input	Feedback/Restart 4	Input (secondo EN 61131-2)
9	A_NO1	Output	N.O. contact Channel 1	
10	B_NO1	Output		
11	A_NO2	Output	N.O. contact Channel 2	
12	B_NO2	Output		
13	A_NO3	Output	N.O. contact Channel 3	
14	B_NO3	Output		
15	A_NO4	Output	N.O. contact Channel 4	
16	B_NO4	Output		
17	SYS_STATUS1	Output	Programmable output status 1	PNP active high
18	SYS_STATUS2	Output	Programmable output status 2	PNP active high
19	SYS_STATUS3	Output	Programmable output status 3	PNP active high
20	SYS_STATUS4	Output	Programmable output status 4	PNP active high
21	SYS_STATUS5	Output	Programmable output status 5	PNP active high
22	SYS_STATUS6	Output	Programmable output status 6	PNP active high
23	SYS_STATUS7	Output	Programmable output status 7	PNP active high
24	SYS_STATUS8	Output	Programmable output status 8	PNP active high

Table 12

## Example of connection of Mosaic to the machine control system

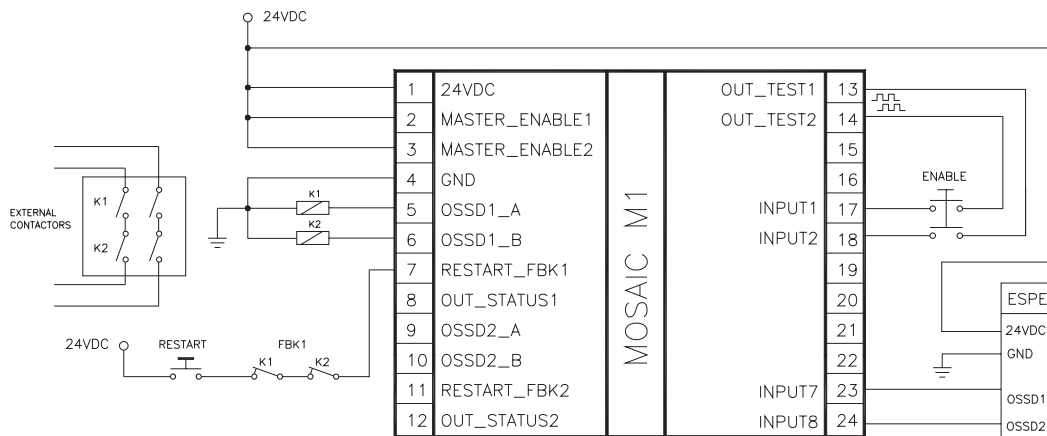

Figure 4

## CHECKLIST AFTER INSTALLATION

The MOSAIC system is able to detect the faults that occurs in each own module. Anyway to have the system perfect operation perform the following checks at start up and at least every one year:

1. Operate a complete system TEST (see "TESTING the system")
2. Verify that all the cables are correctly inserted and the terminal blocks well screwed.
3. Verify that all the leds (indicators) light on correctly.
4. Verify the positioning of all the sensors connected to MOSAIC.
5. Verify the correct fixing of MOSAIC to the Omega rail.
6. Verify that all the external indicators (lamps) work properly.

➔ After installation, maintenance and after any eventual configuration change perform a System TEST as described in the paragraph "TESTING the system" at page 69.

# OPERATING DIAGRAM

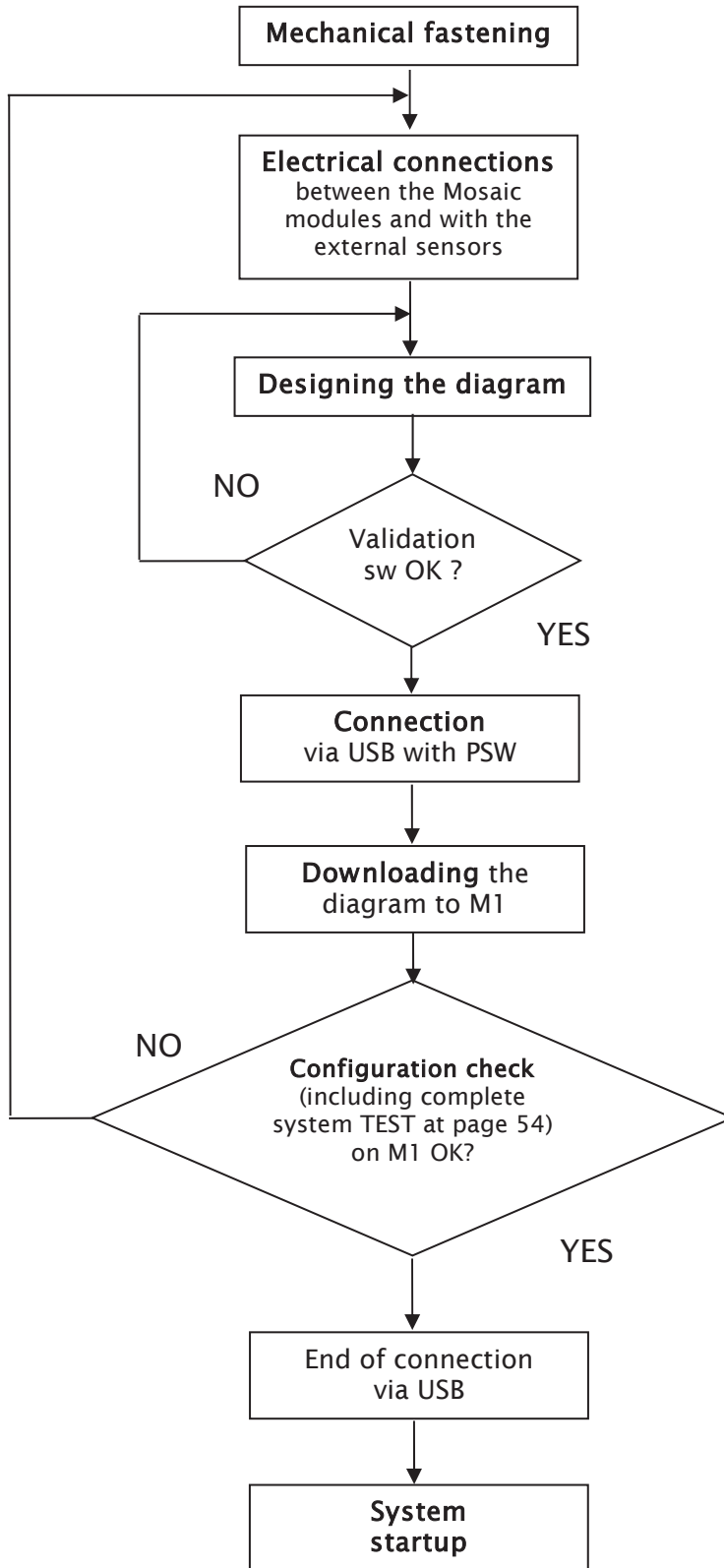

## SIGNALS

### INPUTS

#### MASTER ENABLE

The MOSAIC M1 master has two inputs: MASTER\_ENABLE1 and MASTER\_ENABLE2.

➔ These signals must both be permanently set to logic level 1 (24VDC) for the MOSAIC to operate. If the user needs to disable the MOSAIC simply lower these inputs to logic level 0 (0VDC).

#### NODE SEL

The NODE\_SEL0 and NODE\_SEL1 inputs (on the SLAVE units) are used to attribute a physical address to the slave units with the connections shown in Table 13:

	NODE_SEL1 (Terminal 3)	NODE_SEL0 (Terminal 2)
NODE 0	0 (or not connected)	0 (or not connected)
NODE 1	0 (or not connected)	24VDC
NODE 2	24VDC	0 (or not connected)
NODE 3	24VDC	24VDC

Table 13

➔ It is not allowed to use the same physical address on two units of the same type.



**RESTART\_FBK**

The RESTART\_FBK signal input allows the MOSAIC to verify an EDM (External Device Monitoring) feedback signal (series of contacts) from the external contactors, and to monitor Manual/Automatic operation (See the list of possible connections in Table 14).

- If the application requires it, the response time of the external contactors must be verified by an additional device.
- The RESTART command must be installed outside the danger area in a position where the danger area and the entire work area concerned are clearly visible.
- It must not be possible to reach the control from inside the danger area.

MODE OF OPERATION	EDM	RESTART_FBK
<b>AUTOMATIC</b>	<b>With K1_K2 control</b>	24V
	<b>Without K1_K2 control</b>	24V
<b>MANUAL</b>	<b>With K1_K2 control</b>	24V
	<b>Without K1_K2 control</b>	24V

Table 14

## OUTPUTS

### OUT STATUS

The OUT STATUS signal is a programmable digital output that can indicate the status of:

- An input.
- An output.
- A node of the logic diagram designed using the MSD.

### OUT TEST

The OUT TEST signals must be used to monitor the presence of short-circuits or overloads on the inputs (Figure 5).

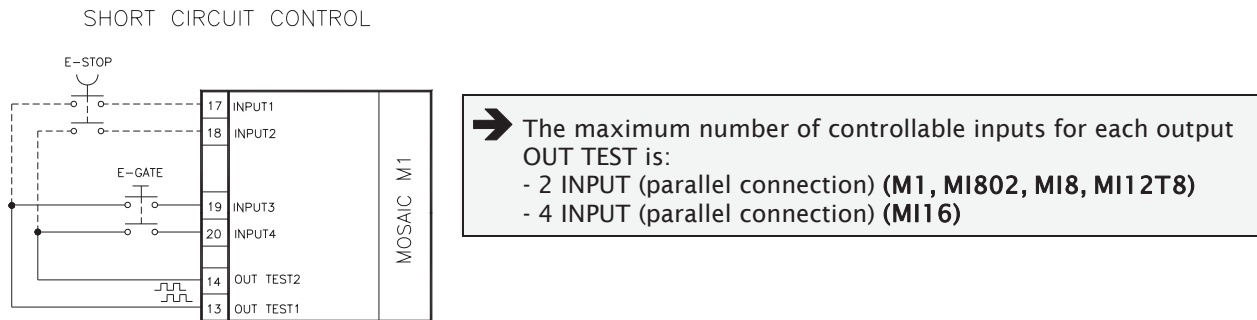

Figure 5

### OSSD (M1, MI802)

The OSSD (*static semiconductor safety outputs*) are short circuit protected, cross circuit monitored and supply:

- In the ON condition:  $U_v - 0,75V \div U_v$  (where  $U_v$  is  $24V \pm 20\%$ )
- In the OFF condition:  $0V \div 2V$  r.m.s.

The maximum load of 400mA@24V corresponds to a minimum resistive load of 60Ω.

The maximum capacitive load is 0.82μF. The maximum inductive load is 30mH.

### OSSD (MO2, MO4)

The OSSD (*static semiconductor safety outputs*) are short circuit protected, cross circuit monitored and supply:

- In the ON condition:  $U_v - 0,75V \div U_v$  (where  $U_v$  is  $24V \pm 20\%$ )
- In the OFF condition:  $0V \div 2V$  r.m.s.

The maximum load of 400mA@24V corresponds to a minimum resistive load of 60Ω.

The maximum capacitive load is 0.82μF. The maximum inductive load is 30mH.

➔ It is not allowed the connection of external devices to the outputs, except as expected in the configuration performed with the MSD software.

Each OSSD output can be configured as shown in Table 15:

<b>Automatic</b>	The output is activated according to le configurations set by the MSD SW only if the corresponding RESTART_FBK input is conected to 24VDC.
<b>Manual</b>	The output is activated according to le configurations set by the MSD SW only if corresponding RESTART_FBK input FOLLOWS A LOGIC TRANSITION OF 0- -> 1.
<b>Monitored</b>	The output is activated according to le configurations set by the MSD SW only if the corresponding RESTART_FBK input FOLLOWS A LOGIC TRANSITION OF 0- -> 1- -> 0.

Table 15

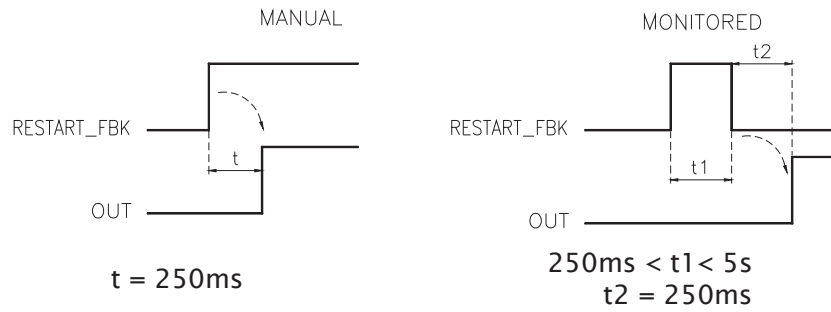

**SAFETY RELAYS (MR2, MR4)**

**Characteristics of the output circuit.**

The MR2/MR4/MOR4/MOR4S8 units use guided contact safety relays, each of which provides **two N.O. contacts and one N.C contact in addition to the N.C. feedback contact**. The MR2 unit uses two safety relays and the MR4/MOR4/MOR4S8 uses four.

Excitation voltage	17...31 VDC
Minimum switchable voltage	10 VDC
Minimum switchable current	20 mA
Maximum switchable voltage (DC)	250VDC
Maximum switchable voltage (AC)	400VAC
Maximum switchable current	6A
Response time	12ms
Mechanical life of contacts	> 20 x 10 <sup>6</sup>

Table 16

- ➔ To guarantee correct isolation and avoid the risk of premature ageing of or damage to the relays, each output line must be protected using a delay 3.5A fuse and the load characteristics must be consistent with those specified in Table 12.
- ➔ See the "MR2 - MR4" section (for further details on these relays).

**MR2/MR4 internal contacts diagram**

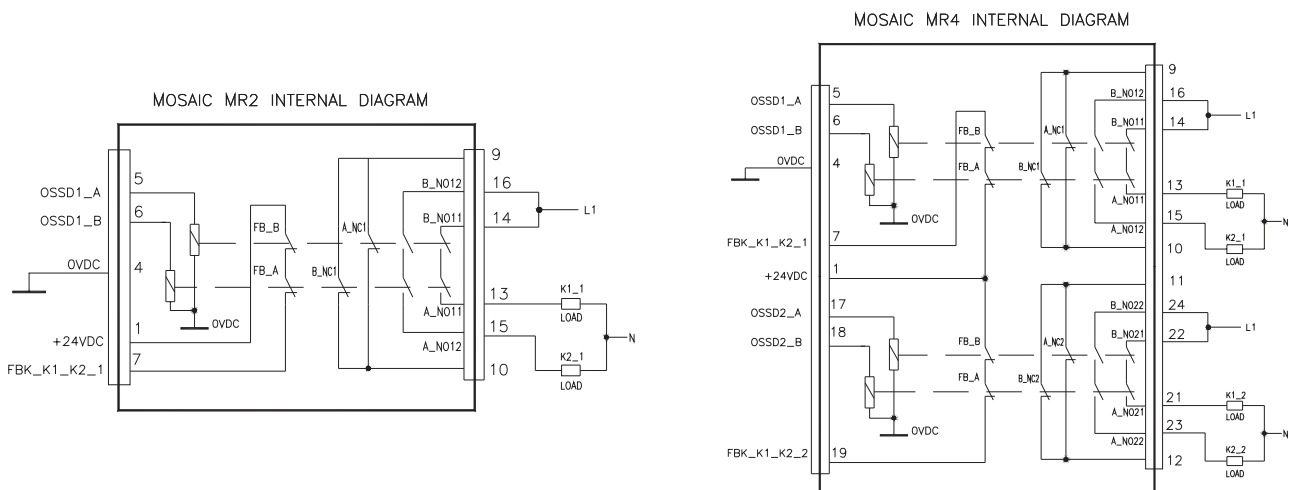

Figure 6

Example of MR2 module connection with static OSSD outputs of a module M1<sup>2</sup>

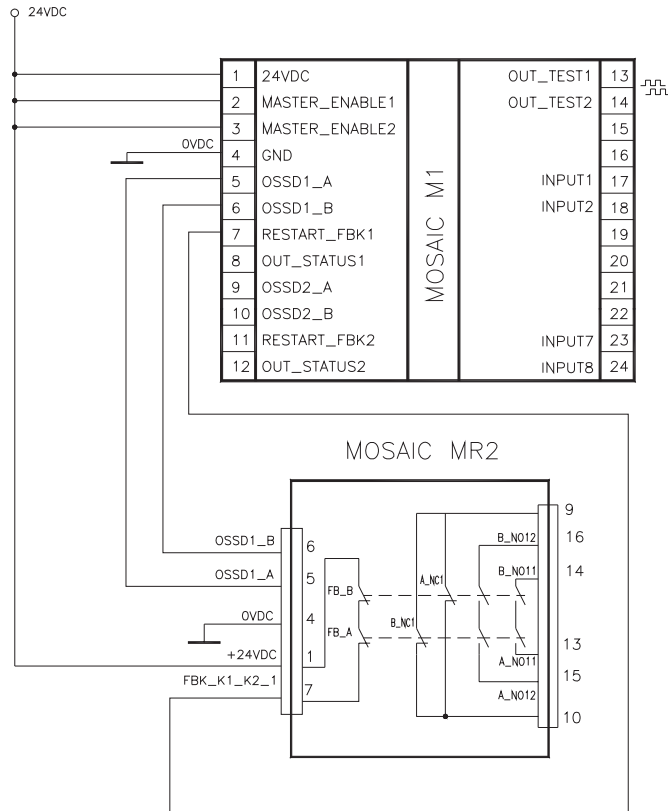

Figure 7

Switching operation timing diagram.

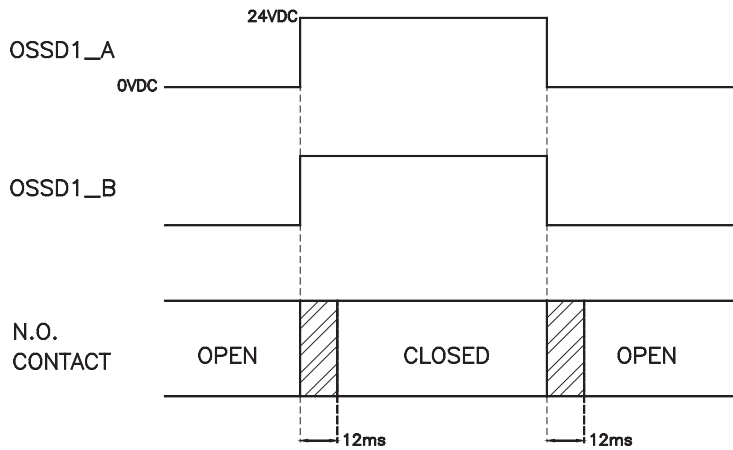

Figure 8

English

<sup>2</sup> If a relay module is connected, the response time of the OSSD linked, must be increased of 12ms.

# TECHNICAL FEATURES

## GENERAL SYSTEM CHARACTERISTICS

### Safety level parameters

Parameter	Value	Standard
PFH <sub>d</sub>	See the technical data tables for each module	IEC 61508:1998
SIL	3	
SILCL	3	IEC 62061:2005
Type	4	EN 61496-1
PL	e	ISO 13849-1:2006 IEC 62061:2005
Dc <sub>avg</sub>	High	
MTTFd (years)	30 ÷ 100	
Category	4	
Device lifetime	20 years	
Pollution degree	2	

### General data

Max number of inputs	128		
Max number of outputs	16		
Max number of slave units (excluding MR2- MR4)	14		
Max number of slave units of the same type (excluding MR2- MR4)	4		
Rated voltage	24VDC ± 20% / Supply from class II (LVLE)		
Over voltage category	II		
Digital INPUTS	PNP active high (EN 61131-2)		
OSSD (M1, M1802, MO2, MO4)	PNP active high - 400mA@24VDC max (each OSSD)		
Digital OUTPUTS	PNP active high - 100mA@24VDC max		
<b>Response time (ms)</b>  <i>This response times depends on the following parameters:</i> 1) Number of Slave modules installed 2) Number of Operators 3) Number of OSSD outputs  For the right response time refer to the one calculated by the MSD software (see Project report)	Master	10,6 ÷ 12,6	+ T <sub>Input_filter</sub>
	M1 + 1 Slave	11,8 ÷ 26,5	+ T <sub>Input_filter</sub>
	M1 + 2 Slaves	12,8 ÷ 28,7	+ T <sub>Input_filter</sub>
	M1 + 3 Slaves	13,9 ÷ 30,8	+ T <sub>Input_filter</sub>
	M1 + 4 Slaves	15 ÷ 33	+ T <sub>Input_filter</sub>
	M1 + 5 Slaves	16 ÷ 35	+ T <sub>Input_filter</sub>
	M1 + 6 Slaves	17 ÷ 37,3	+ T <sub>Input_filter</sub>
	M1 + 7 Slaves	18,2 ÷ 39,5	+ T <sub>Input_filter</sub>
	M1 + 8 Slaves	19,3 ÷ 41,7	+ T <sub>Input_filter</sub>
	M1 + 9 Slaves	20,4 ÷ 43,8	+ T <sub>Input_filter</sub>
	M1 + 10 Slaves	21,5 ÷ 46	+ T <sub>Input_filter</sub>
	M1 + 11 Slaves	22,5 ÷ 48,1	+ T <sub>Input_filter</sub>
	M1 + 12 Slaves	23,6 ÷ 50,3	+ T <sub>Input_filter</sub>
	M1 + 13 Slaves	24,7 ÷ 52,5	+ T <sub>Input_filter</sub>
	M1 + 14 Slaves	25,8 ÷ 54,6	+ T <sub>Input_filter</sub>
M1> module connection	ReeR proprietary 5-pole bus (MSC)		
Connection cable cross- section	0,5 ÷ 2,5 mm <sup>2</sup> / AWG 12÷30 (solid/stranded)		
Max length of connections	100m		
Operating temperature	-10 ÷ 55°C		
Max surrounding air temperature	55°C (UL)		
Storage temperature	-20 ÷ 85°C		
Relative humidity	10% ÷ 95%		

→  $T_{\text{Input\_filter}}$  = max filtering time from among those set on project inputs (see "INPUTS" section).

## Enclosure

Description	Electronic housing max 24 pole, with locking latch mounting
Enclosure material	Polyamide
Enclosure protection class	IP 20
Terminal blocks protection class	IP 2X
Fastening	Quick coupling to rail according to EN 60715
Dimensions (h x l x d)	108 x 22.5 x 114.5

## M1 module

PFH <sub>d</sub> (IEC 61508:1998)	6.06E-9
Rated voltage	24VDC ± 20%
Dissipated power	3W max
Unit enable (No./description)	2 / PNP active high "type B" according to EN 61131-2
Digital INPUTS (No./description)	8 / PNP active high according to EN 61131-2
INPUT FBK/RESTART (No./description)	2 / EDM control / possible Automatic or Manual operation with RESTART button
Test OUTPUT (No./description)	4 / to check for short-circuits - overloads
Digital OUTPUTS (No./description)	2 / programmable - PNP active high
OSSD (No./description)	2 pairs / solid state safety outputs PNP active high 400mA@24VDC max
SLOT for MCM card	Available
Connection to PC	USB 2.0 (Hi Speed) - Max cable length: 3m
Connection to slave units	via MSC 5-way Reer proprietary bus

## MI802 module

PFH <sub>d</sub> (IEC 61508:1998)	5.72E-9
Rated voltage	24VDC ± 20%
Dissipated power	3W max
Digital INPUTS (No./description)	8 / PNP active high according to EN 61131-2
Test OUTPUT (No./description)	8 / to check for short-circuits - overloads
Digital OUTPUTS (No./description)	2 / programmable - PNP active high
OSSD (No./description)	2 pairs / solid state safety outputs: PNP active high - 400mA@24VDC max
Connection to M1	via MSC 5-way Reer proprietary bus

### MI8 - MI16 modules

Model	MI8	MI16
PFH <sub>d</sub> (IEC 61508:1998)	5.75E- 9	7.09E- 9
Rated voltage	24VDC ± 20%	
Dissipated power	3W max	
Digital INPUTS (No./description)	8	16
	PNP active high according to EN 61131-2	
Test OUTPUT (No./description)	4 / to check for short-circuits - overloads	
Connection to M1	via MSC 5-way ReeR proprietary bus	

### MI12T8 module

PFH <sub>d</sub> (IEC 61508:1998)	3.24E-9
Rated voltage	24VDC ± 20%
Dissipated power	3W max
Digital INPUTS (No./description)	12
	PNP active high according to EN 61131-2
Test OUTPUT (No./description)	8 / to check for short-circuits - overloads
Connection to M1	via MSC 5-way ReeR proprietary bus

### MO2 - MO4 modules

Model	MO2	MO4
PFH <sub>d</sub> (IEC 61508:1998)	3.16E-9	3.44E-9
Rated voltage	24VDC ± 20%	
Dissipated power	3W max	
Digital OUTPUTS (No./description)	2	4
	programmable - PNP active high	
OSSD (No./description)	2	4
	Solid state safety outputs: PNP active high 400mA@24VDC max	
Connection to M1	via MSC 5-way ReeR proprietary bus	

### MR2 - MR4 modules

Model	MR2	MR4
Rated voltage	24VDC ± 20%	
Dissipated power	3W max	
Switching voltage	240 VAC	
Switching current	6A max	
N.O. contacts	2 N.O. + 1 N.C.	4 N.O. + 2 N.C.
FEEDBACK contacts	1	2
Response time	12ms	
Mechanical life of contacts	> 20 x 10 <sup>6</sup>	
Connection to output module	Via front-panel terminal strip (no connection via MSC bus)	

MR2 – MR4: TECHNICAL DATA CONCERNING SAFETY										
FEEDBACK CONTACT PRESENT					FEEDBACK CONTACT MISSING					
PFHd	SFF	MTTFd	DCavg		PFHd	SFF	MTTFd	DCavg		
3,09E-10	99,6%	2335,94	98,9%	tcycle1	DC13 (2A)	9,46E-10	0,60	2335,93	tcycle1	DC13 (2A)
8,53E-11	99,7%	24453,47	97,7%	tcycle2		1,08E-10	0,87	24453,47	tcycle2	
6,63E-11	99,8%	126678,49	92,5%	tcycle3		6,75E-11	0,97	126678,5	tcycle3	
8,23E-09	99,5%	70,99	99,0%	tcycle1	AC15 (3A)	4,60E-07	0,50	70,99	tcycle1	AC15 (3A)
7,42E-10	99,5%	848,16	99,0%	tcycle2		4,49E-09	0,54	848,15	tcycle2	
1,07E-10	99,7%	12653,85	98,4%	tcycle3		1,61E-10	0,79	12653,85	tcycle3	
3,32E-09	99,5%	177,38	99,0%	tcycle1	AC15 (1A)	7,75E-08	0,51	177,37	tcycle1	AC15 (1A)
3,36E-10	99,6%	2105,14	98,9%	tcycle2		1,09E-09	0,60	2105,14	tcycle2	
8,19E-11	99,7%	28549,13	97,5%	tcycle3		1,00E-10	0,88	28549,13	tcycle3	

tcycle1: 300s (1 commutation every 5 minutes)

tcycle2: 3600s (1 commutation every hour)

tcycle3: 1 commutation every day

(PFHd according IEC61508, MTTFd and DCavg according ISO13849-1)

## MV0 - MV1 - MV2 modules

Model	MV0	MV1	MV2
Rated voltage	24VDC ± 20%		
Dissipated power max	3W		
Encoder interface	-	TTL (Models MV1T - MV2T) HTL (Models MV1H - MV2H) sin/cos (Models MV1S - MV2S)	
Encoder input signals electrically insulated in accordance with EN 61800-5	Rated insulation voltage <b>250V</b> Overvoltage category II Rated impulse withstand voltage <b>4.00 kV</b>		
Max number of axis	2		
Max number of encoders	0	1	2
Max encoder frequency	-	500KHz (HTL: 300KHz)	
Encoder connections	-	RJ45	
Max number of proximity	2		
Max proximity frequency	5KHz		
Proximity connections	Terminal blocks		
Proximity type	PNP/NPN - 3/4 cables		
Connection to M1	via MSC 5-way Reer proprietary bus		

## MOR4 – MOR4S8 module

Model	MOR4	MOR4S8
Rated voltage	24VDC ± 20%	
Dissipated power max	3W max	
Switching voltage	240 VAC	
Switching current	6A max	
N.O. contacts	4	
INPUT FBK/RESTART (No./description)	4 / EDM control / possible Automatic or Manual operation with RESTART button	
Digital OUTPUT (No./description)	-	8 / Programmable output PNP active high
Response time	12ms	
Mechanical life of contacts	> 40 x 10 <sup>6</sup>	
Connessione per utilizzatore	Terminal blocks	
Connection to M1	via MSC 5-way Reer proprietary bus	



## MECHANICAL DIMENSIONS

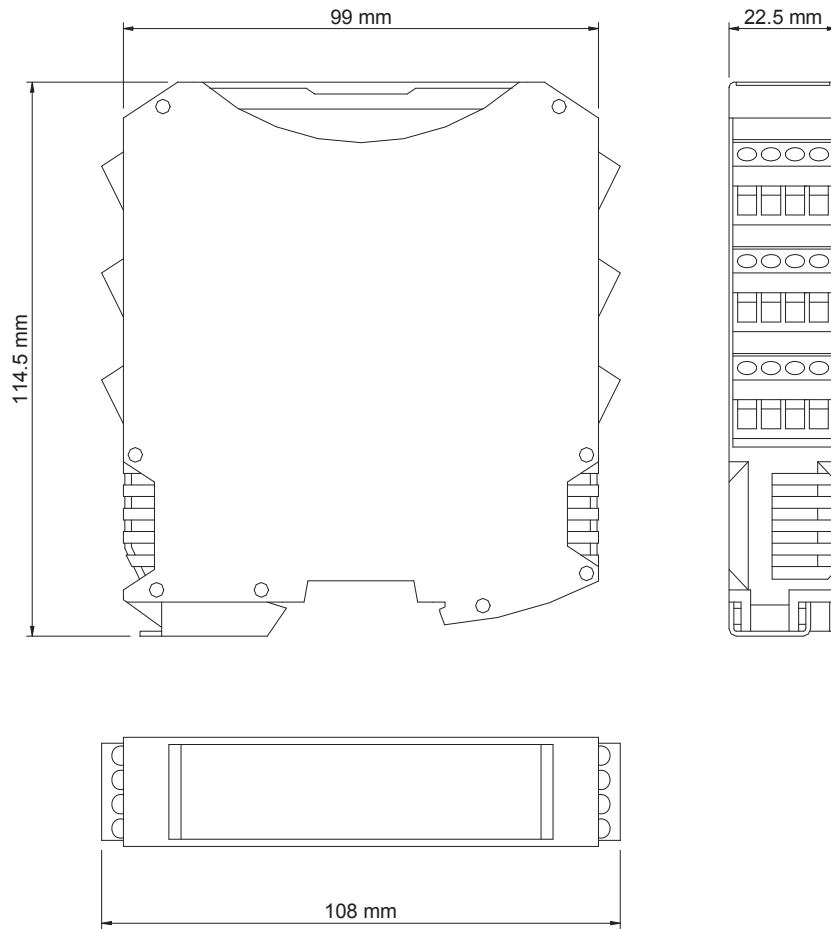
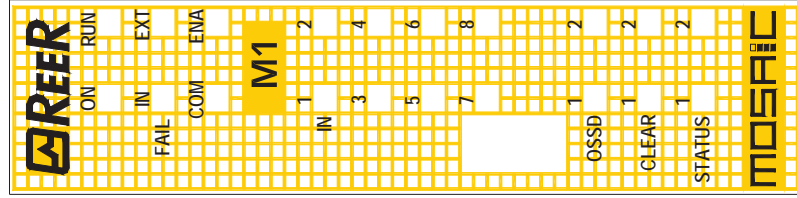

Figure 9

# SIGNALS

Master M1 (Figure 10)



MEANING	LED									
	RUN GREEN	IN FAIL RED	EXT FAIL RED	COM ORANGE	ENA BLUE	IN1÷8 YELLOW	OSSD1/2 RED/GREEN	CLEAR1/2 YELLOW	STATUS1/2 YELLOW	
Power on - initial TEST	ON	ON	ON	ON	ON	ON	Red	ON	ON	
MCM recognised	OFF	OFF	OFF	ON (max 1s)	ON (max 1s)	OFF	Red	OFF	OFF	
Writing/loading/ diagram to/from MCM card	OFF	OFF	OFF	5 flashes	5 flashes	OFF	Red	OFF	OFF	
MSD requesting connection: internal configuration not present	OFF	OFF	OFF	Flashes slowly	OFF	OFF	Red	OFF	OFF	
MSD requesting connection: (slave module or node number not correct) (ref. System composition)	OFF	OFF	OFF	Flashes quickly	OFF	OFF	Red	OFF	OFF	
MSD requesting connection: (slave module missing or not ready) (ref. System composition)	Flashes quickly	OFF	OFF	Flashes quickly	OFF	OFF	Red	OFF	OFF	
MSD connected M1 stopped	OFF	OFF	OFF	ON	OFF	OFF	Red	OFF	OFF	

Table 17 - Opening Screen

Figure 10 - M1

MEANING	LED								
	RUN GREEN	IN FAIL RED	EXT FAIL RED	COM ORANGE	INI ÷ 8 YELLOW	ENA BLUE	OSSD1/2 RED/GREEN	CLEAR1/2 YELLOW	STATUS1/2 YELLOW
NORMAL OPERATION	ON	OFF	OFF op. OK	ON = M1 connected to PC OFF=otherwise	INPUT condition	ON MASTER_ENABLE1 and MASTER_ENABLE2 active OFF otherwise	RED with output OFF GREEN with output ON	ON waiting for RESTART Flashing NO feedback	OUTPUT condition
EXTERNAL FAULT DETECTED	ON	OFF	ON incorrect external connection detected	ON = M1 connected to PC OFF=otherwise	only the number of the INPUT with the incorrect connection flashes				

Table 18 - Dynamic Screen

MI802 (Figure 11)

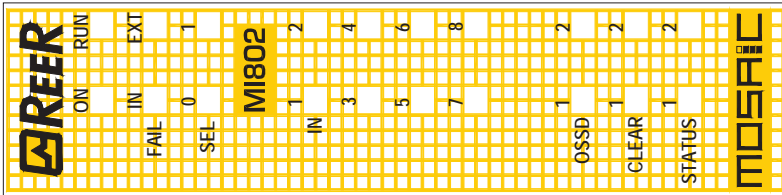

MEANING	LED							
	RUN GREEN	IN FAIL RED	EXT FAIL RED	SEL ORANGE	IN1÷8 YELLOW	OSSD1/2 RED/GREEN	CLEAR1/2 YELLOW	STATUS1/2 YELLOW
Power on - initial TEST	ON	ON	ON	ON	ON	Red	ON	ON

Table 19 - Opening Screen

MEANING	LED							
	RUN GREEN	IN FAIL RED	EXT FAIL RED	IN1÷8 YELLOW	SEL ORANGE	OSSD1/2 RED/GREEN	CLEAR1/2 YELLOW	STATUS1/2 YELLOW
<b>OFF</b> if the unit is waiting for the first communication from the MASTER  <b>FLASHES</b> if no INPUT or OUTPUT requested by the configuration  <b>ON</b> if INPUT or OUTPUT requested by the configuration	ON	OFF	OFF	INPUT condition	Shows the NODE_SELO/1 signal table	<b>RED</b> with output OFF  <b>GREEN</b> with output ON	<b>ON</b> waiting for RESTART  <b>Flashes</b> NO feedback	OUTPUT condition

Table 20 - Dynamic Screen

Figure 11 - MI802

MI8 (Figure 12)

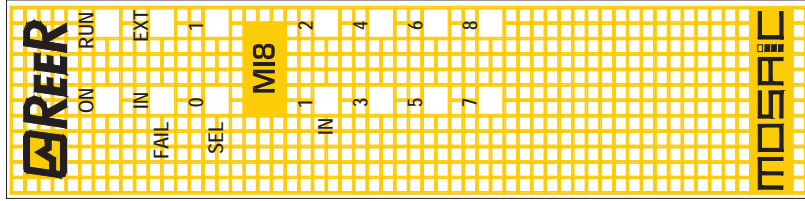

Figure 12 - MI8

MEANING	LED			
	RUN GREEN	IN FAIL RED	EXT FAIL RED	SEL ORANGE
Power on - initial TEST	ON	ON	ON	ON
				IN1 ÷ 8 YELLOW
				ON

Table 21 - Opening Screen

MEANING	LED			
	RUN GREEN	IN FAIL RED	EXT FAIL RED	SEL ORANGE
OFF if the unit is waiting for the first communication from the MASTER			OFF	
FLASHES if no INPUT or OUTPUT requested by the configuration				Shows the NODE_SELO/1 signal table
ON if INPUT or OUTPUT requested by the configuration			ON incorrect external connection detected	
				INPUT condition
				only the number of the INPUT with the incorrect connection flashes

Table 22 - Dynamic Screen

MI12T8 (Figure 14)

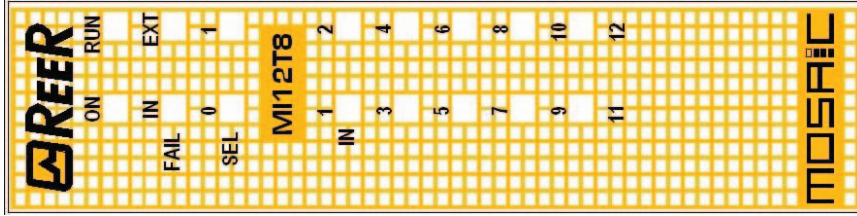
 Figure 13  
 MI12T8

MEANING	LED			
	RUN GREEN	IN FAIL RED	EXT FAIL RED	SEL ORANGE
Power on - initial TEST	ON	ON	ON	ON
				IN1÷12 YELLOW
				ON

Table 23 - Opening Screen

MEANING	LED			
	RUN GREEN	IN FAIL RED	EXT FAIL RED	SEL ORANGE
OFF if the unit is waiting for the first communication from the MASTER				
FLASHES if no INPUT or OUTPUT requested by the configuration				
ON if INPUT or OUTPUT requested by the configuration				
				IN1÷12 YELLOW
				INPUT condition
				Shows the NODE_SELO/1 signal table
				only the number of the INPUT with the incorrect connection flashes

Table 24 - Dynamic Screen

MI16 (Figure 14)

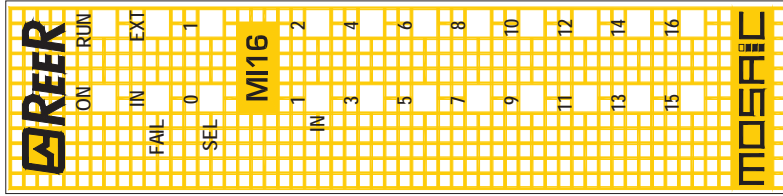

Figure 14 - MI16

MEANING	LED					
	RUN GREEN	IN FAIL RED	EXT FAIL RED	SEL ORANGE	IN1 ÷ 16 YELLOW	
Power on - initial TEST	ON	ON	ON	ON	ON	ON

Table 25 - Opening Screen

MEANING	LED					
	RUN GREEN	IN FAIL RED	EXT FAIL RED	SEL ORANGE	IN1 ÷ 16 YELLOW	
OFF if the unit is waiting for the first communication from the MASTER	ON	ON	ON	ON	ON	ON
FLASHES if no INPUT or OUTPUT requested by the configuration	OFF	OFF	OFF	OFF	OFF	OFF
ON if INPUT or OUTPUT requested by the configuration	ON	ON	ON	ON	ON	ON
NORMAL OPERATION	Shows the NODE_SEL0/1 signal table	OFF	OFF	OFF	OFF	OFF
		ON incorrect external connection detected	ON	ON	ON	ON
INPUT condition						
only the number of the INPUT with the incorrect connection <b>flashes</b>						

Table 26 - Dynamic Screen

MO2 (Figure 15)

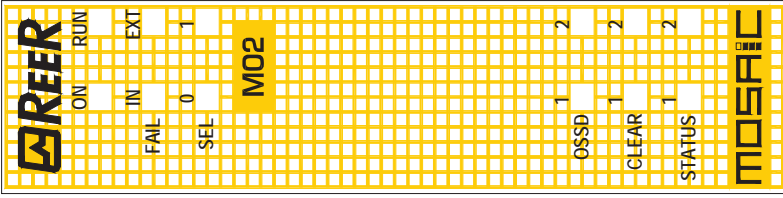

Figure 15 - MO2

MEANING	LED						
	RUN GREEN	IN FAIL RED	EXT FAIL RED	SEL ORANGE	OSDD1/2 RED/GREEN	CLEAR1/2 YELLOW	STATUS1/2 YELLOW
Power on - initial TEST	ON	ON	ON	ON	Red	ON	ON

Table 27 - Opening screen

MEANING	LED						
	RUN GREEN	IN FAIL RED	EXT FAIL RED	SEL ORANGE	OSDD1/2 RED/GREEN	CLEAR1/2 YELLOW	STATUS1/2 YELLOW
OFF if the unit is waiting for the first communication from the MASTER					RED with output OFF	ON waiting for RESTART	OUTPUT condition
FLASHES if no INPUT or OUTPUT requested by the configuration				Shows the NODE_SELO/1 signal table	GREEN with output ON	Flashes NO feedback	
ON if INPUT or OUTPUT requested by the configuration		OFF op. OK	OFF op. OK				

Table 28 - Dynamic screen



MO4 (Figure 16)

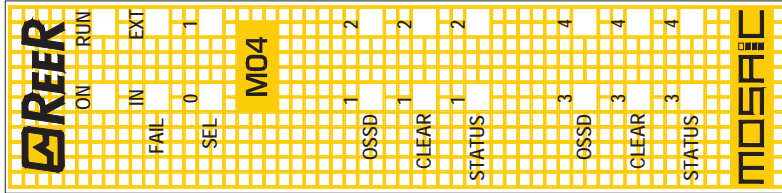

Figure 16 - MO4

MEANING	LED						
	RUN GREEN	IN FAIL RED	EXT FAIL RED	SEL ORANGE	OSDD1/4 RED/GREEN	CLEAR1/4 YELLOW	STATUS1/4 YELLOW
Power on - initial TEST	ON	ON	ON	ON	Red	ON	ON

Table 29 - Opening screen

MEANING	LED						
	RUN GREEN	IN FAIL RED	EXT FAIL RED	SEL ORANGE	OSDD1/4 RED/GREEN	CLEAR1/4 YELLOW	STATUS1/4 YELLOW
OFF if the unit is waiting for the first communication from the MASTER					RED with output OFF	ON waiting for RESTART	
FLASHES if no INPUT or OUTPUT requested by the configuration				Shows the NODE_SELO/1 signal table	GREEN with output ON	Flashes NO feedback	
ON if INPUT or OUTPUT requested by the configuration		OFF op. OK	OFF op. OK				OUTPUT condition

Table 30 - Dynamic screen

MOR4 (Figure 17)

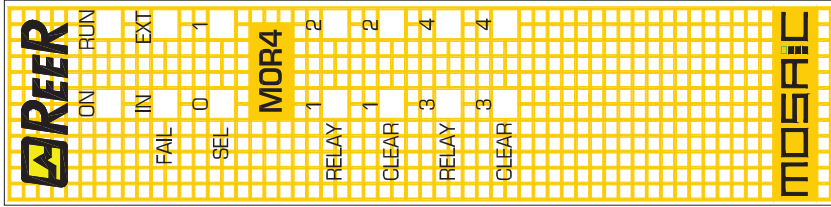

Figure 17 - MOR4

MEANING	LED											
	RUN		IN FAIL		EXT FAIL		SEL 0/1		RELAY 1/4		CLEAR 1/4	
	GREEN	ON	RED	ON	RED	ON	ORANGE	ON	RED	GREEN	RED	YELLOW
Power on - initial TEST	ON	ON	ON	ON	ON	ON	ON	ON	Red	Red	Red	ON

Table 31 - Opening screen

MEANING	LED												
	RUN		IN FAIL		EXT FAIL		SEL 0/1		RELAY 1/4		CLEAR 1/4		
	GREEN	ON	RED	RED	RED	RED	ORANGE	ON	RED	GREEN	RED	YELLOW	
NORMAL OPERATION	OFF	if the unit is waiting for the first communication from the MASTER	OFF	if no INPUT or OUTPUT requested by the configuration	OFF	operation OK	OFF	operation OK	Shows the NODE_SELO/1 signal table	RED	with contact opened	ON	waiting for RESTART
	ON	if INPUT or OUTPUT requested by the configuration	ON	with contact closed	ON	with contact closed	ON	with contact closed	ON	with contact closed	ON	with contact closed	ON

Table 32 - Dynamic screen

MOR4S8 (Figure 18)

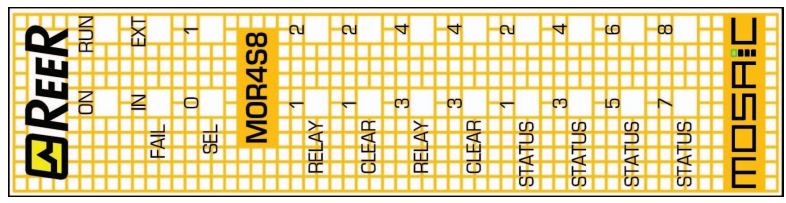

Figure 18 - MOR4S8

MEANING	LED							
	RUN	IN FAIL	EXT FAIL	SEL 0/1	RELAY 1/4		CLEAR1/4	STATUS1/8
	GREEN	RED	RED	ORANGE	RED	GREEN	YELLOW	YELLOW
Power on - initial TEST	ON	ON	ON	ON	Red		ON	ON

Table 33 - Opening screen

MEANING	LED							
	RUN	IN FAIL	EXT FAIL	SEL 0/1	RELAY 1/4		CLEAR1/4	STATUS1/8
	GREEN	RED	RED	ORANGE	RED	GREEN	YELLOW	YELLOW
NORMAL OPERATION	OFF							
	if the unit is waiting for the first communication from the MASTER							
FLASHES	if no INPUT or OUTPUT requested by the configuration							
	ON							
	if INPUT or OUTPUT requested by the configuration							
	Shows the NODE_SEL0/1 signal table							
	OFF operation OK							
	OFF operation OK							
	RED with contact opened							
	RED							
	ON waiting for RESTART							
	GREEN with contact closed							
	GREEN							
	FLASHES wrong feedback external contactors							
	FLASHES							
	OUTPUT condition							

Table 34 - Dynamic screen

MV1, MV2 (Figure 19)

MEANING	LED						
	RUN	IN FAIL	EXT FAIL	SEL	ENC*	PROX	SH
	GREEN	RED	RED	ORANGE	YELLOW	YELLOW	YELLOW
Power on - initial TEST	ON	ON	ON	ON	ON	ON	ON

Table 35 - Opening screen

MEANING	LED						
	RUN	IN FAIL	EXT FAIL	SEL	ENC*	PROX	SH
	GREEN	RED	RED	ORANGE	YELLOW	YELLOW	YELLOW
NORMAL OPERATION	OFF if the unit is waiting for the first communication from the MASTER	OFF operation OK	OFF operation OK	Shows the NODE_SELO/1 signal table	ON Encoder connected and operative	ON Proximity connected and operative	OFF Axis in normal speed range
	FLASHES if no INPUT or OUTPUT requested by the configuration	OFF operation OK	OFF operation OK				ON Axis in stand still
	ON if INPUT or OUTPUT requested by the configuration						BLINKING Axis in overspeed

Table 36 - Dynamic screen

\* NOT PRESENT ON MVO MODULE

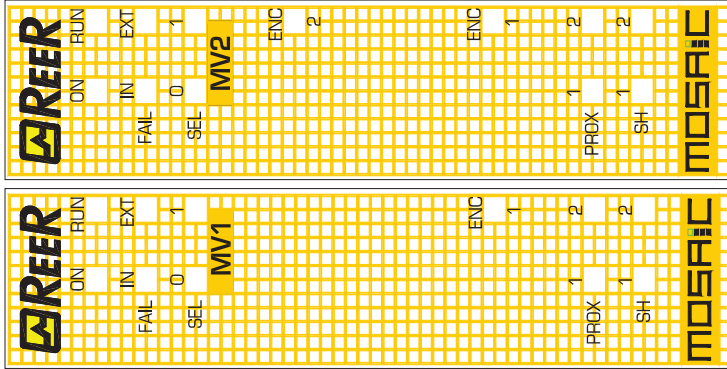

Figure 19 - MV1, MV2

## MR2 (Figure 20) / MR4 (Figure 21)

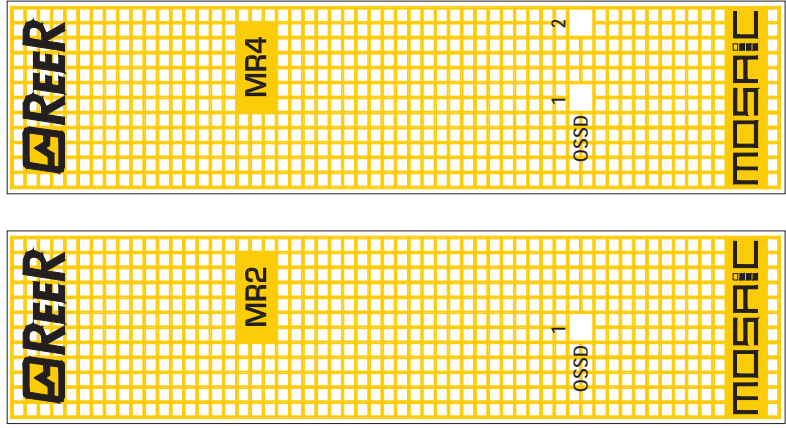

Figure 20 - MR2      Figure 21 - MR4

MEANING	LED	ON with output activated
	OSSD1 GREEN	
NORMAL OPERATION		

Table 37 - MR2 - Dynamic screen

MEANING	LED	ON with output activated
	OSSD1 GREEN	
NORMAL OPERATION		

Table 38 - MR4 - Dynamic screen

## TROUBLESHOOTING

Master M1 (Figure 22)

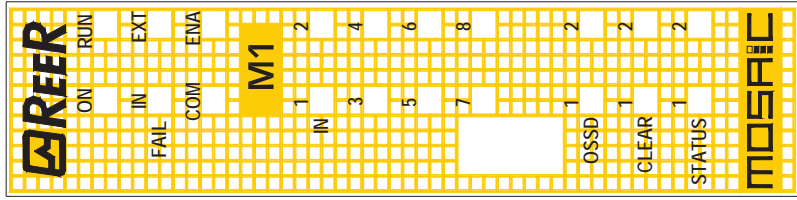

Figure 22 - M1

MEANING	LED										REMEDY
	RUN GREEN	IN FAIL RED	EXT FAIL RED	COM ORANGE	IN1 ÷ 8 YELLOW	ENA BLUE	OSSD1/2 RED/GREEN	CLEAR1/2 YELLOW	STATUS1/2 YELLOW		
Internal fault	OFF	2 or 3 flashes	OFF	OFF	OFF	OFF	Red	OFF	OFF	OFF	Return the unit to Reer to be repaired
OSSD output error	OFF	4 flashes	OFF	OFF	OFF	OFF	4 flashes (only the LED corresponding to the output in FAIL mode)	OFF	OFF	OFF	<ul style="list-style-type: none"> <li>Check the OSSD1/2 connections</li> <li>If the problem persists return the M1 to Reer to be repaired</li> </ul>
Error in communication with slave	OFF	5 flashes	OFF	OFF	OFF	OFF	OFF	OFF	OFF	OFF	<ul style="list-style-type: none"> <li>Restart the system.</li> <li>If the problem persists return the M1 to Reer to be repaired</li> </ul>
Slave unit error	OFF	ON	OFF	OFF	OFF	OFF	OFF	OFF	OFF	OFF	<ul style="list-style-type: none"> <li>Restart the system</li> <li>Check which unit is in FAIL mode</li> </ul>
MCM error	OFF	6 flashes	OFF	6 flashes	OFF	OFF	OFF	OFF	OFF	OFF	Replace the MCM

Table 39 - Troubleshooting M1

MI802 (Figure 23)

MEANING	LED										REMEDY
	RUN GREEN	IN FAIL RED	EXT FAIL RED	SEL ORANGE	IN1 ÷ 8 YELLOW	OSSD1/2 RED/GREEN	CLEAR1/2 YELLOW	STATUS1/2 YELLOW			
Internal fault	OFF	2 or 3 flashes	OFF		OFF	Red	OFF	OFF	Return the unit to Reer to be repaired		
Compatibility error	OFF	5 flashes	OFF		5 flashes	5 flashes	5 flashes	5 flashes	Firmware version not compatible with M1, return to Reer for FW upgrade.		
OSSD output error	OFF	4 flashes	OFF	Shows the physical address of the unit	OFF	4 flashes (only the LED corresponding to the output in FAIL mode)	OFF	OFF	Check OSSD1/2 connections		
Error in communication with master	OFF	5 flashes	OFF		OFF	OFF	OFF	OFF	Restart the system if the problem persists, return the MI802 to Reer to be repaired		
Error on other slave or M1	OFF	ON	OFF		OFF	OFF	OFF	OFF	Restart the system		
Same type of slave with same address detected	OFF	5 flashes	5 flashes		OFF	OFF	OFF	OFF	Restart the system if the problem persists, return the MI802 to Reer to be repaired		
Node detection circuit error	OFF	3 flashes	OFF	3 flashes	OFF	OFF	OFF	OFF	Restart the system		

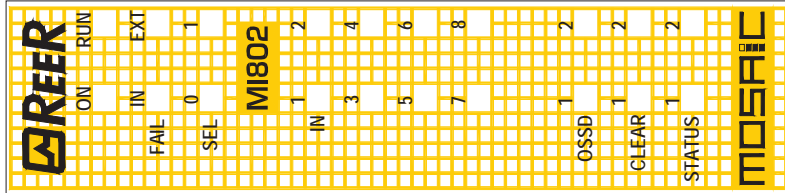

Table 40 - Troubleshooting MI802

Figure 23 - MI802

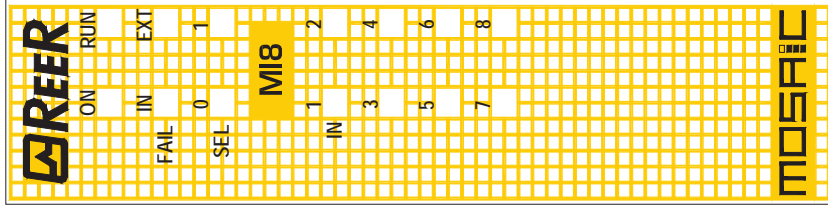

Figure 24 - MI8

MI8 (Figure 24)

MEANING	LED				REMEDY
	RUN GREEN	IN FAIL RED	EXT FAIL RED	SEL ORANGE	
Internal fault	OFF	2 or 3 flashes	OFF	OFF	<ul style="list-style-type: none"> <li>Return the unit to ReeR to be repaired</li> </ul>
Compatibility error	OFF	5 flashes	OFF	5 flashes	<ul style="list-style-type: none"> <li>Firmware version not compatible with M1, return to ReeR for FW upgrade.</li> </ul>
Error in communication with master	OFF	5 flashes	OFF	Shows the physical address of the unit	<ul style="list-style-type: none"> <li>Restart the system</li> <li>If the problem persists, return the MI8 to ReeR to be repaired</li> </ul>
Error on other slave or M1	OFF	ON	OFF	OFF	<ul style="list-style-type: none"> <li>Restart the system</li> <li>Check which unit is in FAIL mode</li> </ul>
Same type of slave with same address detected	OFF	5 flashes	5 flashes	OFF	<ul style="list-style-type: none"> <li>Change the unit's address (see <b>NODE SEL</b>)</li> </ul>
Node detection circuit error	OFF	3 flashes	OFF	3 flashes	<ul style="list-style-type: none"> <li>Return the unit to ReeR to be repaired</li> </ul>

Table 41 - Troubleshooting MI8



MI12T8 (Figure 25)

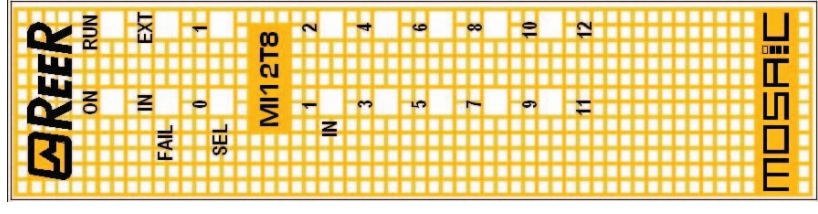
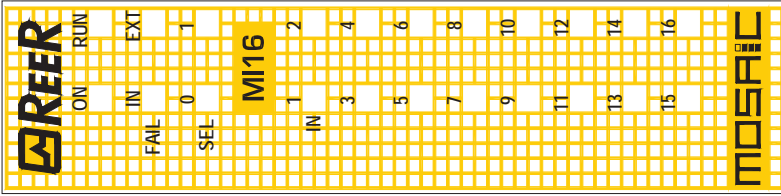

Figure 25 - MI12T8

MEANING	LED						REMEDY
	RUN GREEN	IN FAIL RED	EXT FAIL RED	SEL ORANGE	IN 1 ÷ 12 YELLOW		
Internal fault	OFF	2 or 3 flashes	OFF	Shows the physical address of the unit	OFF	Return the unit to ReeR to be repaired	
Compatibility error	OFF	5 flashes	OFF		5 flashes	<ul style="list-style-type: none"> <li>• Firmware version not compatible with M1, return to ReeR for FW upgrade.</li> </ul>	
Error in communication with master	OFF	5 flashes	OFF		OFF	<ul style="list-style-type: none"> <li>• Restart the system</li> <li>• If the problem persists, return the MI12T8 to ReeR to be repaired</li> </ul>	
Error on other slave or M1	OFF	ON	OFF		OFF	<ul style="list-style-type: none"> <li>• Restart the system</li> <li>• Check which unit is in FAIL mode</li> </ul>	
Same type of slave with same address detected	OFF	5 flashes	5 flashes		OFF	<ul style="list-style-type: none"> <li>• Change the unit's address (see <b>NODE SEL</b>)</li> </ul>	
Node detection circuit error	OFF	3 flashes	OFF	3 flashes	OFF	<ul style="list-style-type: none"> <li>• Return the unit to ReeR to be repaired</li> </ul>	

Table 42 - Troubleshooting MI12T8

MI16 (Figure 26 - MI16)



MEANING	LED						REMEDY
	RUN GREEN	IN FAIL RED	EXT FAIL RED	SEL ORANGE	IN1÷16 YELLOW		
Internal fault	OFF	2 or 3 flashes	OFF		OFF	5 flashes	<ul style="list-style-type: none"> <li>Return the unit to ReeR to be repaired</li> <li>Firmware version not compatible with M1, return to ReeR for FW upgrade.</li> </ul>
Compatibility error	OFF	5 flashes	OFF				<ul style="list-style-type: none"> <li>Restart the system</li> <li>If the problem persists, return the MI16 to ReeR to be repaired</li> </ul>
Error in communication with master	OFF	5 flashes	OFF				<ul style="list-style-type: none"> <li>Restart the system</li> <li>Check which unit is in FAIL mode</li> </ul>
Error on other slave or M1	OFF	ON	OFF				<ul style="list-style-type: none"> <li>Restart the system</li> <li>Change the unit's address (see <b>NODE SEL</b>)</li> </ul>
Same type of slave with same address detected	OFF	5 flashes	5 flashes				<ul style="list-style-type: none"> <li>Change the unit's address (see <b>NODE SEL</b>)</li> </ul>
Node detection circuit error	OFF	3 flashes	OFF			3 flashes	<ul style="list-style-type: none"> <li>Return the unit to ReeR to be repaired</li> </ul>

Table 43 - Troubleshooting MI16

Figure 26 - MI16

MO2 / MO4 (Figure 27)

MEANING	LED										REMEDY	
	RUN	IN FAIL	EXT FAIL	SEL	OSSD1/4	CLEAR1/4	STATUS1/4					
	GREEN	RED	RED	ORANGE	RED/GREEN	YELLOW	YELLOW	RED	YELLOW	YELLOW		
Internal fault	OFF	2 or 3 flashes	OFF	ORANGE	Red	OFF	OFF			OFF	OFF	Return the unit to Reer to be repaired
Compatibility error	OFF	5 flashes	OFF		5 flashes	5 flashes	5 flashes			5 flashes	5 flashes	<ul style="list-style-type: none"> <li>Firmware version not compatible with M1, return to Reer for FW upgrade.</li> </ul>
OSSD output error	OFF	4 flashes	OFF		4 flashes (only the LED corresponding to the output in FAIL mode)	OFF	OFF			OFF	OFF	<ul style="list-style-type: none"> <li>Check OSSD1/2 connections</li> <li>If the problem persists, return the MO2/4 to Reer to be repaired</li> </ul>
Error in communication with master	OFF	5 flashes	OFF	Shows the physical address of the unit	OFF	OFF	OFF			OFF	OFF	<ul style="list-style-type: none"> <li>Restart the system</li> <li>If the problem persists, return the MO2/4 to Reer to be repaired</li> </ul>
Error on other slave or M1	OFF	ON	OFF		OFF	OFF	OFF			OFF	OFF	<ul style="list-style-type: none"> <li>Restart the system</li> <li>Check which unit is in FAIL mode</li> </ul>
Same type of slave with same address detected	OFF	5 flashes	5 flashes		5 flashes	5 flashes	5 flashes			5 flashes	5 flashes	<ul style="list-style-type: none"> <li>Change the unit's address (see <b>NODE SEL</b>)</li> </ul>
Power supply missing on OSSD 3,4 (MO4 only)	ON	OFF	ON		Red flashes	flashes	OUTPUT condition			flashes	OUTPUT condition	<ul style="list-style-type: none"> <li>Connect 13 and 14 pin to power supply</li> </ul>
Status output overload or short circuit	OFF	OFF	ON		OUTPUT condition	CLEAR condition	flashes			CLEAR condition	flashes	<ul style="list-style-type: none"> <li>Check STATUS connections</li> </ul>
Error on node detection circuit	OFF	3 flashes	OFF	3 flashes	OFF	OFF	OFF			OFF	OFF	<ul style="list-style-type: none"> <li>Return the MO2/4 to Reer to be repaired</li> </ul>

Table 44 - Troubleshooting MO2/MO4

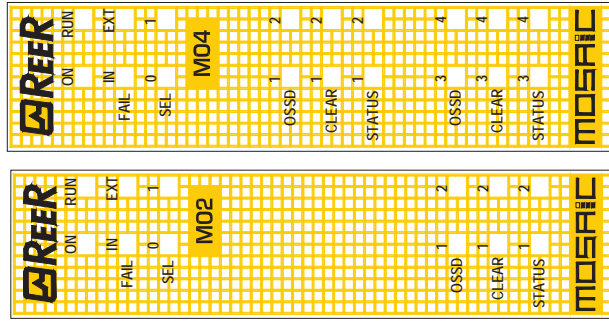

Figure 27 - MO2 / MO4

MOR4 (Figure 28)

MEANING	LED								REMEDY
	RUN GREEN		IN FAIL RED		EXT FAIL RED		SEL 0/1 ORANGE		
	RELAY 1/4 GREEN		RELAY 1/4 RED		CLEAR1/4 YELLOW				
Internal fault	OFF	2 / 3 flashes	OFF	OFF		Rosso	OFF	OFF	<ul style="list-style-type: none"> <li>Return the unit to Reer to be repaired</li> </ul>
Compatibility error	OFF	5 flashes	OFF	OFF		5 flashes	5 flashes	5 flashes	<ul style="list-style-type: none"> <li>Firmware version not compatible with M1, return to Reer for FW upgrade.</li> </ul>
Relais output error	OFF	4 flashes	OFF	OFF		4 flashes (only the LED corresponding to the output in FAIL mode)	OFF	OFF	<ul style="list-style-type: none"> <li>If the problem persists, return the module to Reer to be repaired</li> </ul>
Error in communication with master	OFF	5 flashes	OFF	OFF		Shows the physical address of the unit	OFF	OFF	<ul style="list-style-type: none"> <li>Restart the system</li> <li>If the problem persists, return the module to Reer to be repaired</li> </ul>
Error on other slave or M1	OFF	ON	OFF	OFF			OFF	OFF	<ul style="list-style-type: none"> <li>Restart the system</li> <li>Check which unit is in FAIL mode</li> </ul>
Same type of slave with same address detected	OFF	5 flashes	5 flashes	5 flashes			OFF	OFF	<ul style="list-style-type: none"> <li>Change the unit's address (see <b>NODE SEL</b>)</li> </ul>
External contactors feedback error on Category 4 relay	ON	OFF	4 flashes	4 flashes			4 flashes (only the LEDs corresponding to the outputs in FAIL mode)	4 flashes	<ul style="list-style-type: none"> <li>Verify connections 5,6,7,8.</li> </ul>
Error on node detection circuit	OFF	3 flashes	OFF	OFF		3 flashes	OFF	OFF	<ul style="list-style-type: none"> <li>Return the module to Reer to be repaired</li> </ul>

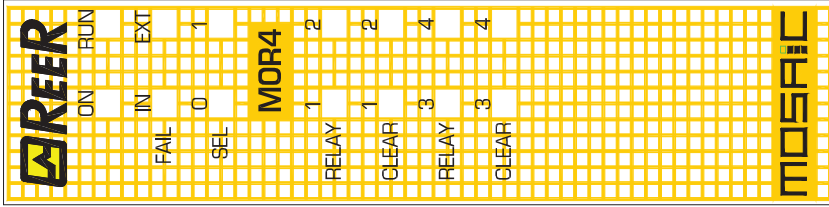

Figure 28 - MOR4

Table 45 - Troubleshooting MOR4

MOR4S8 (Figure 29)

MEANING	LED										REMEDY				
	RUN		IN FAIL		EXT FAIL		SEL 0/1		RELAY 1/4			CLEAR1/4		STATUS1/8	
	GREEN	RED	RED	RED	RED	ORANGE	RED	GREEN	RED	GREEN		YELLOW	YELLOW	YELLOW	
Internal fault	OFF	2 / 3 flashes	OFF	OFF	OFF		Rosso			OFF					
Compatibility error	OFF	5 flashes	OFF	OFF			5 flashes			5 flashes			5 flashes		
Relays output error	OFF	4 flashes	OFF	OFF			4 flashes (only the LED corresponding to the output in FAIL mode)			OFF			OFF		
Error in communication with master	OFF	5 flashes	OFF	OFF		Shows the physical address of the unit	OFF			OFF			OFF		
Error on other slave or M1	OFF	ON	OFF	OFF			OFF			OFF			OFF		
Same type of slave with same address detected	OFF	5 flashes	5 flashes	5 flashes			OFF			OFF			OFF		
External contactors feedback error on Category 4 relay	ON	OFF	4 flashes	4 flashes			4 flashes (only the LEDs corresponding to the outputs in FAIL mode)			OFF			OFF		
Error on node detection circuit	OFF	3 flashes	OFF	OFF			3 flashes			OFF			OFF		
Short circuit or overload detected on status output	OFF	OFF	ON	ON			OUTPUT condition			CLEAR condition			flash		

Table 46 - Troubleshooting MOR4

Figure 29 - MOR4S8

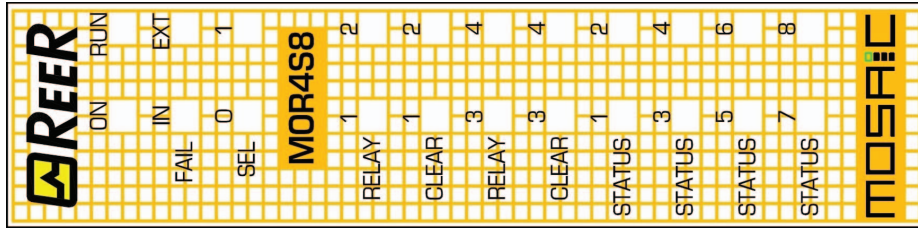

MVO, MV1, MV2 (Figure 29)

MEANING	LED							REMEDY	
	RUN	IN FAIL	EXT FAIL	SEL	ENC*	PROX	SH		
	GREEN	RED	RED	ORANGE	YELLOW	YELLOW	YELLOW		
Internal fault	OFF	2 or 3 flashes	OFF		OFF	OFF	OFF	<ul style="list-style-type: none"> <li>Return the unit to Reer to be repaired</li> </ul>	
Compatibility error	OFF	5 flashes	OFF		OFF	OFF	OFF	<ul style="list-style-type: none"> <li>Firmware version not compatible with M1, return to Reer for FW upgrade.</li> </ul>	
<ul style="list-style-type: none"> <li>Encoder not connected but requested from the configuration</li> <li>Encoder EXTERNAL error</li> </ul>	OFF	OFF	3 flashes		3 flashes	OFF	OFF	<ul style="list-style-type: none"> <li>Verify encoder connection and power supply</li> <li>Verify input frequency (in range)</li> </ul>	
Encoder INTERNAL error	OFF	3 flashes	OFF	Shows the physical address of the unit	3 flashes	OFF	OFF	<ul style="list-style-type: none"> <li>Change the encoder</li> <li>Return the unit to Reer to be repaired</li> </ul>	
<ul style="list-style-type: none"> <li>Proximity not connected but requested from the configuration</li> <li>Proximity external error</li> </ul>	OFF	OFF	3 flashes		OFF	3 flashes	OFF	OFF	<ul style="list-style-type: none"> <li>Verify proximity connection and power supply</li> <li>Verify input frequency (in range)</li> </ul>
Proximity INTERNAL error		3 flashes	OFF			3 flashes			<ul style="list-style-type: none"> <li>Change the proximity</li> <li>Return the unit to Reer to be repaired</li> </ul>
Same type of slave with same address detected	OFF	5 flashes	5 flashes		OFF	OFF	OFF	<ul style="list-style-type: none"> <li>Change the unit's address (see <b>NODE SEL</b>)</li> </ul>	
Error on node detection circuit	OFF	3 flashes	OFF	3 flashes	OFF	OFF	OFF	<ul style="list-style-type: none"> <li>Return the unit to Reer to be repaired</li> </ul>	

Table 47 - Troubleshooting MV1/MV2

\* NOT PRESENT ON MVO MODULE

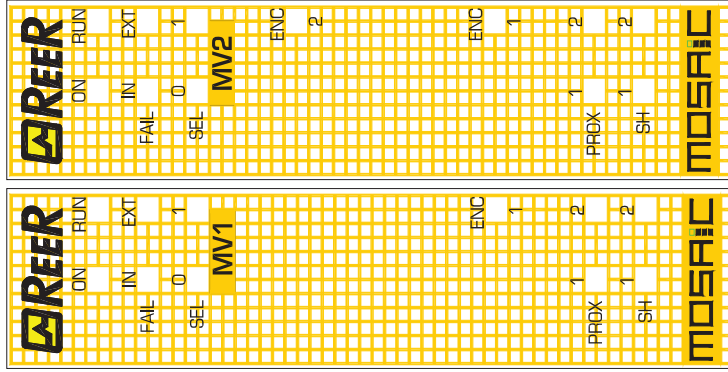

Figure 30 - MV1, MV2

---

## MOSAIC SAFETY DESIGNER SOFTWARE

---

The "*MOSAIC SAFETY DESIGNER*" application software can be used to configure a logic diagram of the connections between the MOSAIC (Master + expansions) and the components of the system being developed.

The MOSAIC and its SLAVE units will thus monitor and control the connected safety components.

The MSD uses a versatile graphic interface to establish the connections between the various components, as described below:

---

### Installing the software

---

---

#### PC HARDWARE requirements

---

- RAM: 256 MB  
(adequate to run *Windows XP SP3 + Framework 4.0*)
- Hard disk:  $\geq$  500Mbyte of free space
- USB connector: 1.1, 2.0 or 3.0
- CD-ROM drive

---

#### PC SOFTWARE requirements

---

- Windows XP with Service Pack 3 installed (or higher OS).

**➔** Microsoft Framework 4.0 (or higher) must be installed on the PC

---

#### How to install MSD

---

- Insert the installation CD;
- Wait for the auto-run installer to request the SW setup program;

Alternatively follow the path D:/;

- Double-click on the **SetupDesigner.exe** file;

When the installation procedure is complete a window is displayed asking you to close the setup program.

Fundamentals

Once the MSD has been correctly installed it creates an icon on the desktop.

To launch the program: double-click on this icon. =>



The opening screen shown below is displayed:

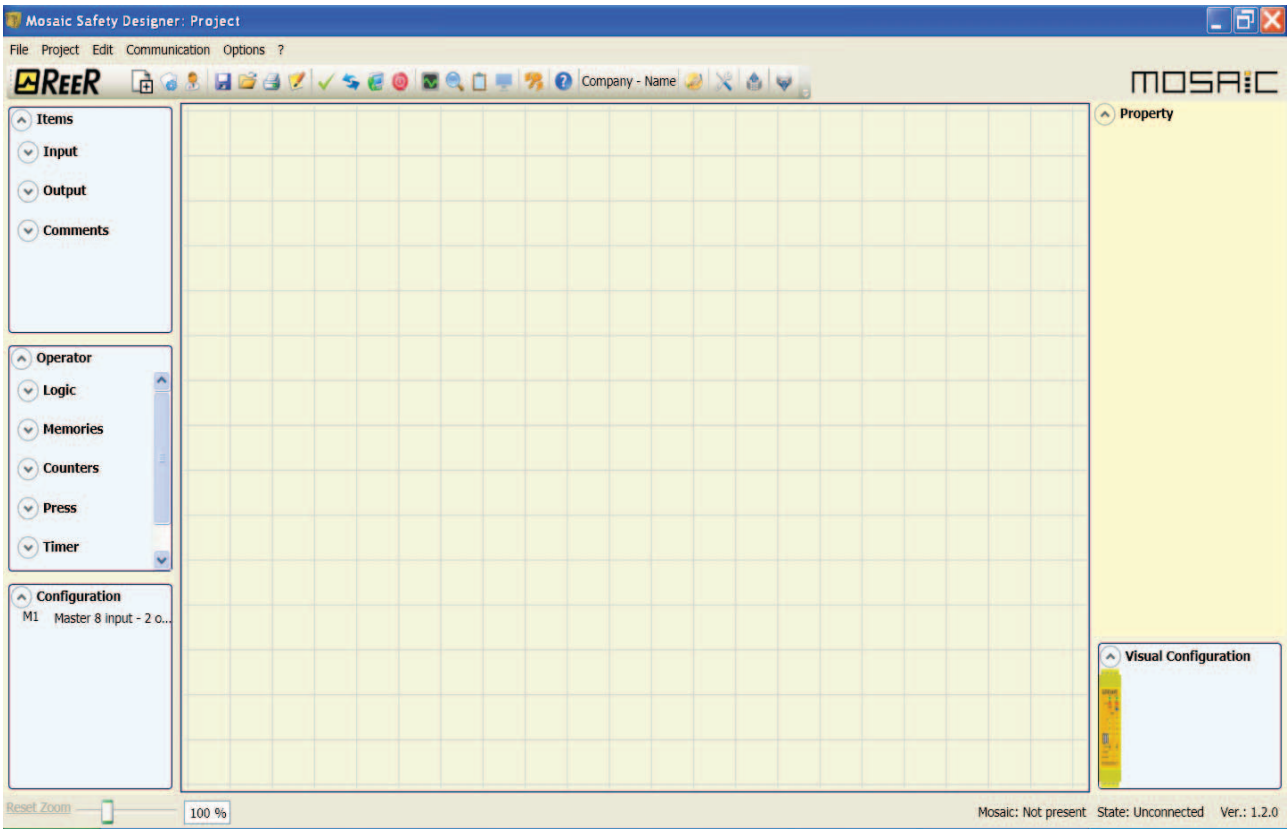

Figure 31

You are now ready to create your project.

























## Standard tool bar

The standard tool bar is shown in Figure 32. The meanings of the icons are listed below:



Figure 32

- |       |   |  |
|-------|---|--|
| 1 ->  |    | <b>CREATE A NEW PROJECT</b>                                    |
| 2 ->  |    | <b>CHANGE CONFIGURATION</b> (composition of different modules) |
| 3 ->  |    | <b>CHANGE USER PARAMETERS</b> (name, company, etc)             |
| 4 ->  |    | <b>SAVE THE ACTUAL PROJECT</b>                                 |
| 5 ->  |    | <b>LOAD AN EXISTING PROJECT (FROM THE PC)</b>                  |
| 6 ->  |    | <b>PRINT THE PROJECT SCHEMATIC</b>                             |
| 7 ->  |    | <b>PRINT PREVIEW</b>   |
| 8 ->  |    | <b>PRINTING AREA</b>   |
| 9 ->  |    | <b>PRINT THE PROJECT REPORT</b>                                |
| 10 -> |   | <b>UNDO (CANCEL THE LAST COMMAND)</b>                          |
| 11 -> |  | <b>REDO (RESTORE THE LAST CANCELLATION)</b>                    |
| 12 -> |  | <b>VALIDATE THE PROJECT</b>                                    |
| 13 -> |  | <b>CONNECT TO MOSAIC</b>                                       |
| 14 -> |  | <b>SEND PROJECT TO MOSAIC</b>                                  |
| 15 -> |  | <b>DISCONNECT FROM MOSAIC</b>                                  |
| 16 -> |  | <b>DOWNLOAD AN EXISTING PROJECT (FROM MOSAIC)</b>              |
| 17 -> |  | <b>MONITOR</b> (Real time I/O status - <b>graphic</b> )        |
| 18 -> |  | <b>MONITOR</b> (Real time I/O status - <b>textual</b> )        |
| 19 -> |  | <b>DOWNLOAD LOG FILE</b>                                       |
| 20 -> |  | <b>SHOW SYSTEM CONFIGURATION</b>                               |
| 21 -> |  | <b>CHANGE PASSWORD</b>   |
| 22 -> |  | <b>HELP ON- LINE</b>   |
| 23 -> |  | <b>PASSWORD RECOVERY</b>                                       |

Textual tool bar

Optionally the textual tool bar shown below is also available (drop down).



Figure 33

Create a new project (configure the MOSAIC system)

Select icon CREATE (Figure 32) from the standard tool bar to start a new project. The user authentication window is displayed (Figure 34).

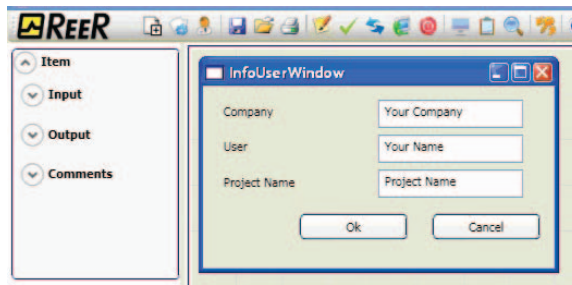
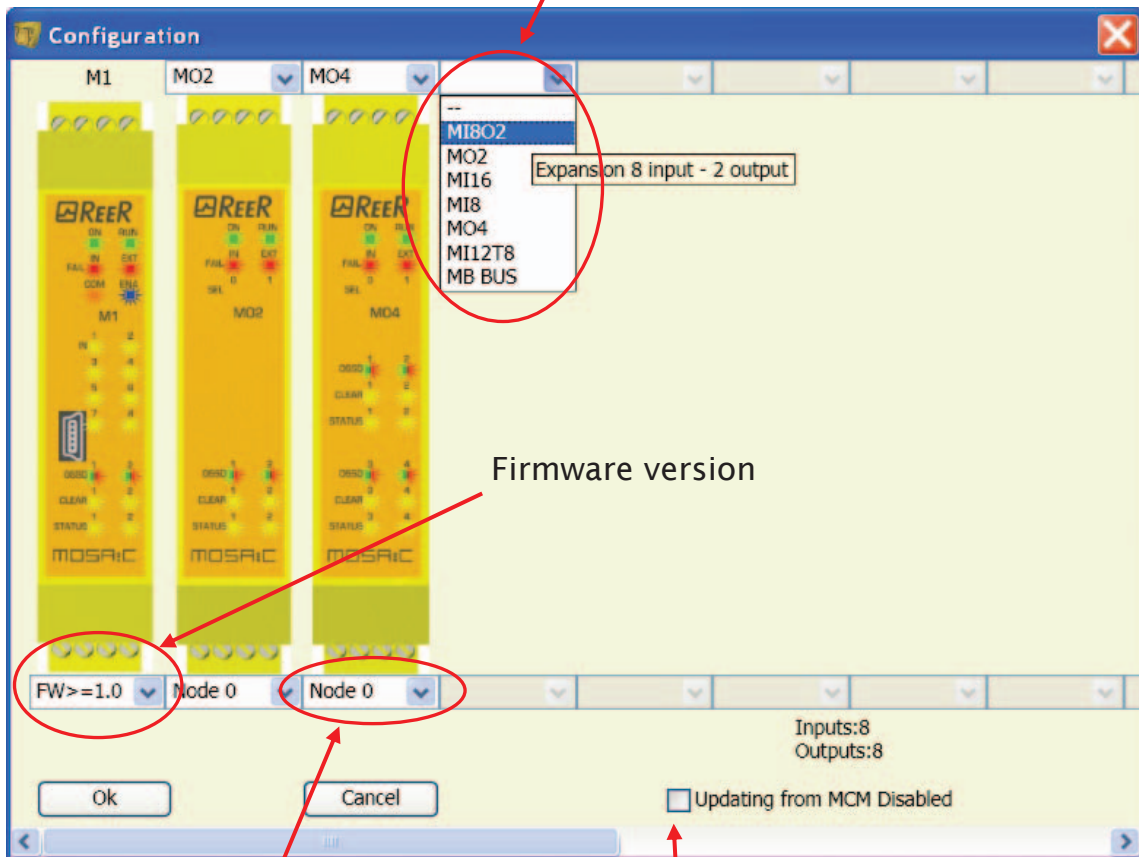

Figure 34

Next the MSD displays a window showing the M1 only. You may add the various units needed to create your system, using the pull-down menus at the top of the screen (select slave) and at the bottom to select the relative node (0÷3).

**SELECT SLAVE** (to add to your configuration)



Firmware version

**SELECT NODE** (from 0 to 3)

Select to disable MCM operations

Figure 35

english

EDIT CONFIGURATION (composition of the various modules)

The change of the system composition is obtained with the icon . The configuration window is showed again (Figure 32).

Change user parameters

The change of user parameters is obtained with the icon . The dialog user identification request appears (Figure 36). To accomplish this operation is not necessary to Log out from Mosaic. Generally it serves when a new user must create a new project (even using a previously created).

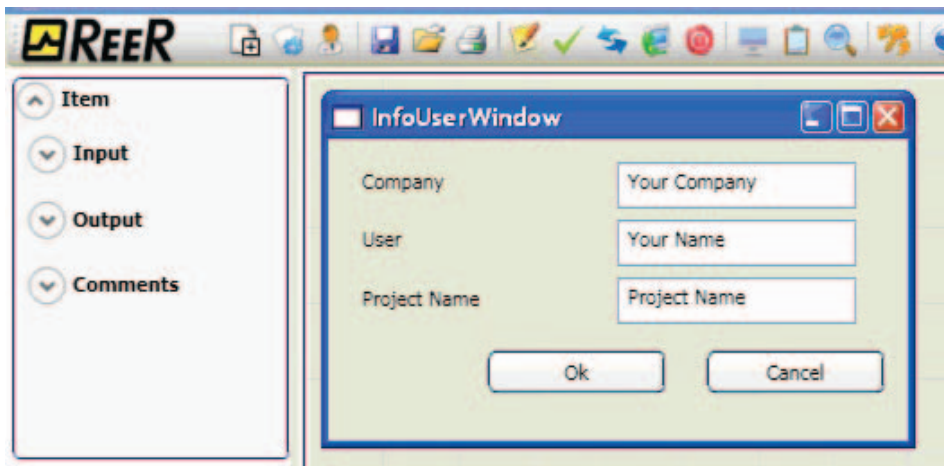

Figure 36

**OBJECTS - OPERATOR - CONFIGURATION tool bars**

Four large tool windows are displayed to the left and right of the main window (shown in Figure 37):

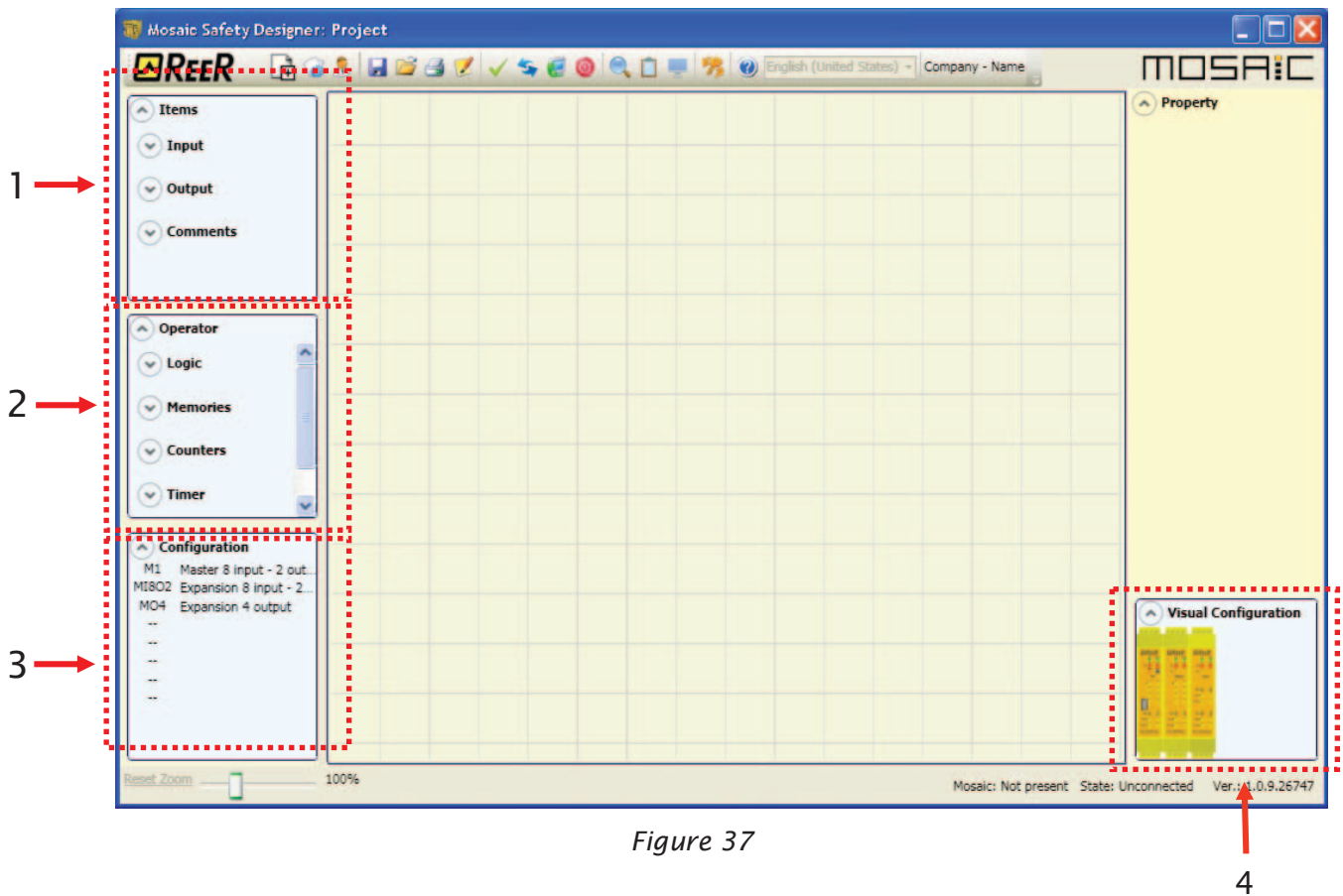

Figure 37

**1 > OBJECT TOOL WINDOW**

This contains the various function blocks that will make up your project; these blocks are divided into 3 different types:

- physical
- inputs
- outputs
- comments

**2 > OPERATOR TOOL WINDOW**

This contains the various function blocks for connecting the objects in point 1; these blocks are divided into 6 different types:

- logical
- muting
- memories
- counters
- timers

**3 > CONFIGURATION TOOL WINDOW**

This contains the description of your project composition.

**4 > CONFIGURATION TOOL WINDOW (view)**

This contains the graphic representation of your project composition.

---

## Creating the diagram

---

Once you have selected your system composition, you are ready to configure the project.

The logic diagram is created using a **DRAG&DROP** function:

- Select the objects as required from the windows described previously (each single object is described in detail in the following sections) and drag it into the design area.
- Now when you select the object the **PROPERTIES** window is enabled, where you must fill in the fields as required.
- When you need to set a specific numerical value with a slide (eg filter) use the left and right arrows on your keyboard or click the sides of the slider of the slide.
- Connect the objects by moving the mouse over the required pin and then dragging it onto the pin to be connected.
- If the scheme requires the PAN function (moving working area in the window), select the object to move and use the arrow keys on your keyboard.
- When you need to duplicate an object, select it and press CTRL+C / CTRL+V keys on your keyboard.
- When you need to delete an object or a link, select it and press DEL key on your keyboard.

## Use of mouse right button

### ON BLOCK INPUT / OUTPUT

- Copy / Paste
- Delete
- Delete all the assigned pins
- Alignment with other functional blocks (multiple selection)
- On-line Help
- Monitor Mode: Show / Hide Properties window
- The block Status: pin input enable / disable logical negation

### ON BLOCK OPERATORS

- Copy / Paste
- Delete
- Alignment with other functional blocks (multiple selection)
- On-line Help
- On input pin: activate / deactivate logical negation
- Monitor Mode: Show / Hide Properties window

### ON TERMINALS

- Alignment with other blocks

### ON CONNECTION (WIRES)

- Delete
- Display full path of the connection (network)

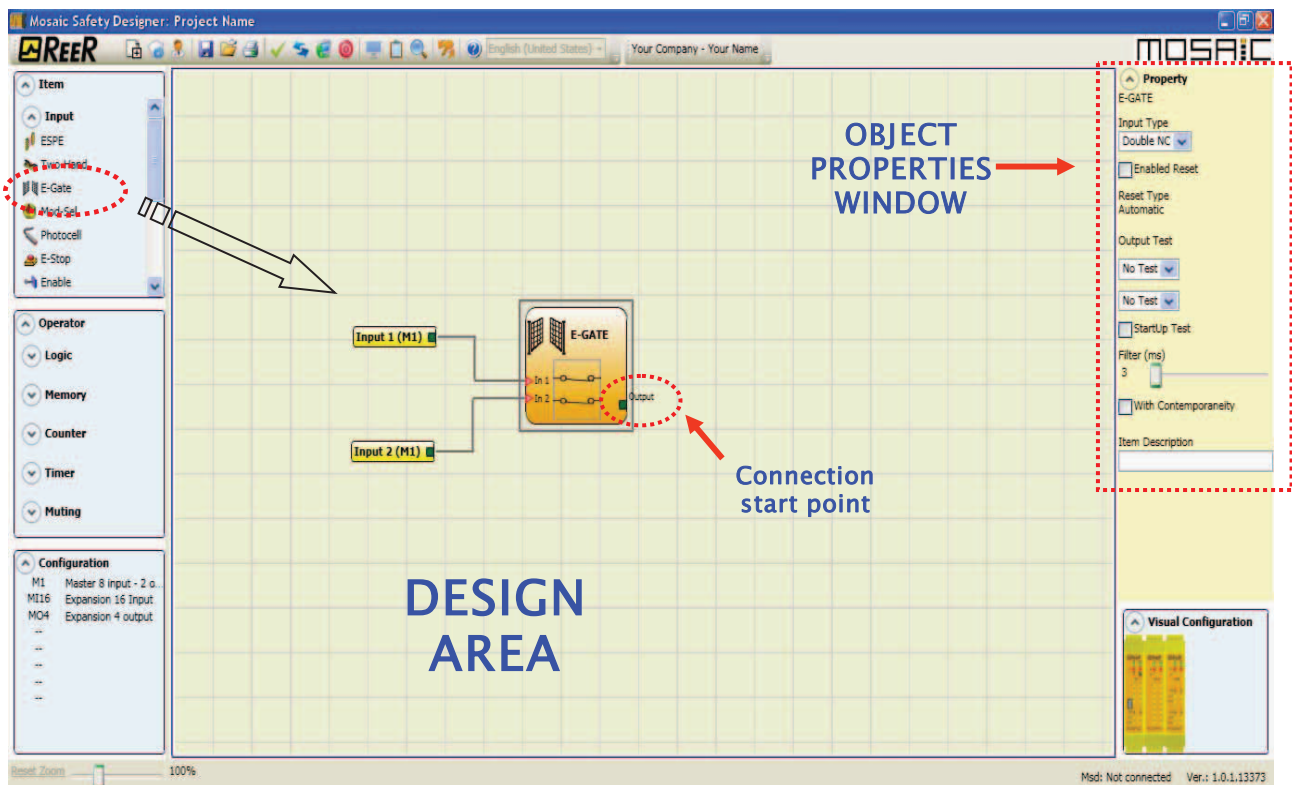

Figure 38

## Example of a project

Figure 39 shows an example of a project in which the M1 unit only is connected to two safety blocks (E-GATE and E-STOP).

The M1 inputs (1,2,3) for connecting the contacts of the safety components are shown on the left, in yellow. The MOSAIC outputs (from 1 to 4) are activated according to the conditions defined in E-GATE and E-STOP (see the *E-GATE* - *E-STOP* sections).

By clicking on a block to select it, you enable the PROPERTIES WINDOW on the right, which you can use to configure the block activation and test parameters (see the *E-GATE* - *E-STOP* sections).

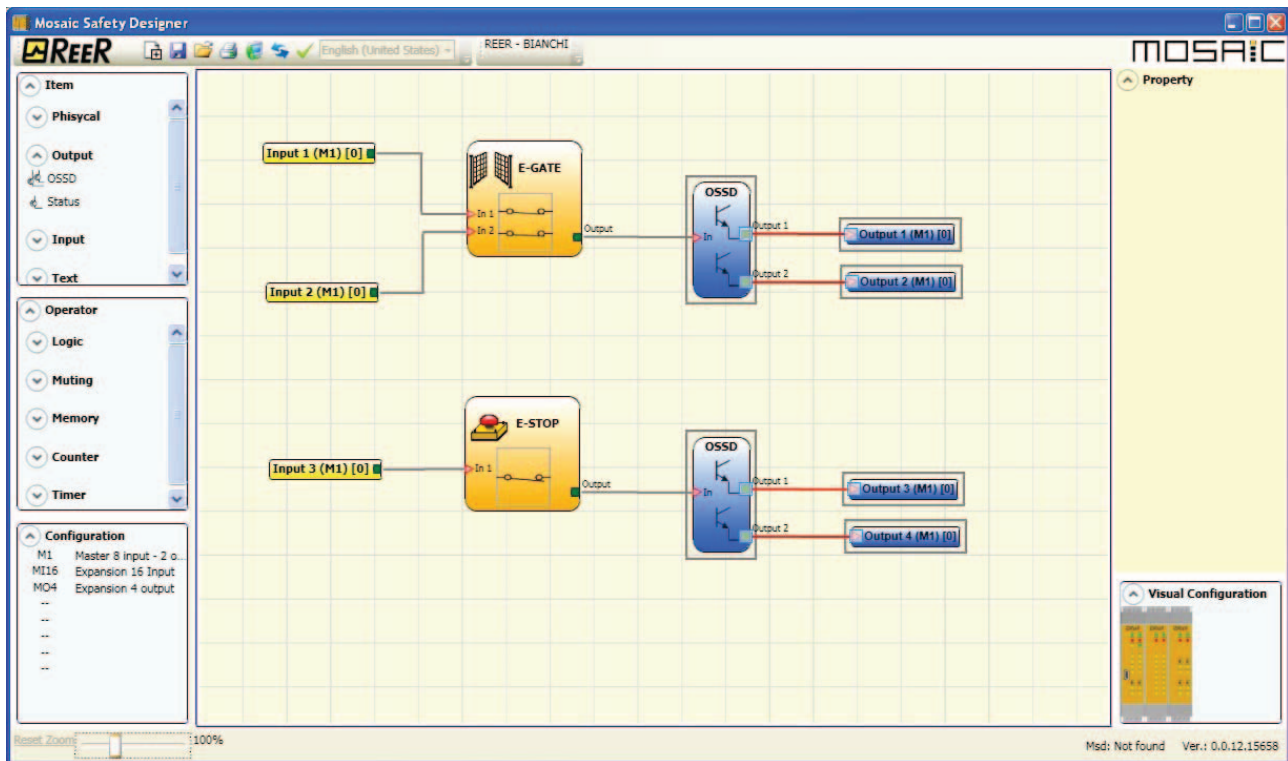



Figure 39

At the end of the project design stage (or at intermediate steps) you can save the current configuration using the icon **SAVE** on the standard tool bar.

## Project validation

➔ Now the finished project must be verified. Execute the VALIDATE command (Icon  on the standard toolbar).

If the validation is successful, a sequential number is assigned to the input and output of the project. Then, this number is also listed in the REPORT and in the MONITOR of MSD. Only if the validation is successful we will proceed to send the configuration.

 The validation function only verifies the consistency of programming with respect to the characteristics of the MOSAIC system. It does not guarantee that the device has been programmed to meet all the safety requirements for the application.

## Project report

Print of the System composition with properties of each block. (Icon  on the standard toolbar).



MODular SAFety Integrated Controller

Project Report generated by Mosaic Safety Designer version 1.2.0

Project Name: Sch24 SOLID STATE DEVICE  
 User: Greco  
 Company: Reer  
 Date: 07/11/2011 14:28:48  
 Schematic CRC: 3A4BH

Mosaic: Configuration  
 Module M1 (Configured Firmware version: >= 1.0)  
 Module M18O2 Node 0  
 Module M18O2 Node 1  
 Module M04 Node 0  
 Module M112T8 Node 0

Mosaic: Safety Information's  
 PFHd (according to IEC 61508): 2,42E-008 (1/h)  
 MITFd (according to EN ISO 13849-1): 85 years  
 DCavg (according to EN ISO 13849-1): 98,04 %

Resources used

INPUT: 22% (8/36)  
 Functional Blocks: 3

Timing: 6% (1/16)  
 Total number blocks: 5% (3/64)

OSSD: 50% (5/10)  
 STATUS: 20% (2/10)

Electrical diagram



SSD  
 Functional Block 1  
 Filter (ms): 3  
 Contemporaneity (ms): 10  
 Reset Type: Automatic  
 StartUp Test: True  
 Connections:  
 M1 INPUT1/Terminal17  
 M1 INPUT2/Terminal18

SSD  
 Functional Block 2  
 Filter (ms): 100  
 Contemporaneity (ms): 500  
 Reset Type: Manual  
 StartUp Test: False  
 Connections:  
 M18O2 - 0 INPUT1/Terminal17  
 M18O2 - 0 INPUT2/Terminal18  
 M18O2 - 0 INPUT3/Terminal19

SSD  
 Functional Block 3  
 Filter (ms): 250  
 Contemporaneity (ms): 1000  
 Reset Type: Monitored  
 StartUp Test: False



Via Carcano, 32  
 10153 Torino Italia  
<http://www.reer.it>

-  This definition of PL and of the other related parameters as set forth in ISO 13849-1 only refers to the functions implemented in the Mosaic system by the MSD configuration software, assuming configuration has been performed correctly.
-  The actual PL of the entire application and the relative parameters must consider data for all the devices connected to the Mosaic system within the scope of the application.
-  This must only be performed by the user/installer.



## Connect to Mosaic

After connecting M1 to the PC via CSU cable (USB) use the icon  for the connection. A window appears to request the password. Enter the password (see "Password protection").

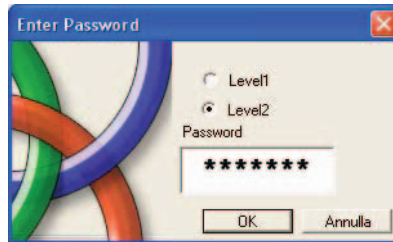



Figure 40

## Sending the configuration to the MOSAIC

To send the saved configuration from a PC to M1 use the icon  on the standard toolbar and wait the execution. M1 will save the project in its internal memory and (if present) in MCM memory. (Password Required: level 2).

➔ This function is possible only after project validation with OK result.

## Download a configuration file (project) from Mosaic M1

To download a project from MOSAIC M1 to MSD use the icon  on the Standard toolbar. MSD will display the project residing in M1. (Sufficient Password level 1).

➔ If the project must be used on other modules M1 verify the components effectively connected (ref. "System composition" on page 66).

➔ Then perform a "Project Validation" (page 63) and a "System Test" (page 69).

## Configuration LOG

➔ Within the configuration file (project), are included the **creation date** and **CRC (4- digit hexadecimal identification)** of a project that are stored in M1.

➔ This logbook can record up to 5 consecutive events, after which these are overwritten, starting from the least recent event.

The log file can be visualized using the icon  in the standard tool bar. (Password Required: level 1).

Date	CRC
09/11/10	9F96H
09/11/10	AE0EH
04/11/10	F0F4H
04/11/10	F0F4H
03/11/10	4CC3H

Exit

Figure 41

**System composition**

The check of the actual composition of the MOSAIC system is obtained using the icon



(Password Required: level 1). A pop-up window will appear with:

- Connected modules;
- Firmware version of each module;
- Node number (physical address) of each module.

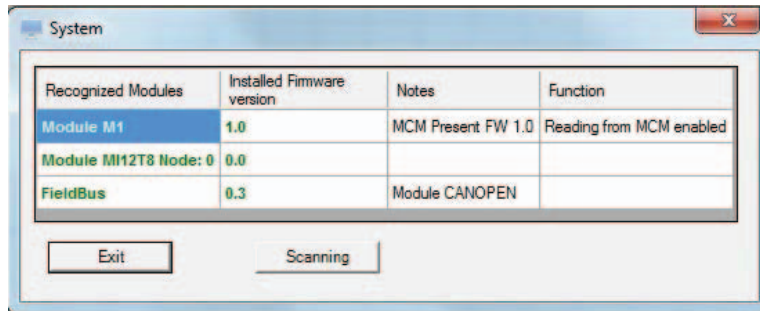

Figure 42

If the modules found are not correct the following window will appear; e.g. M12T8 node number not correct (displayed in red color text).

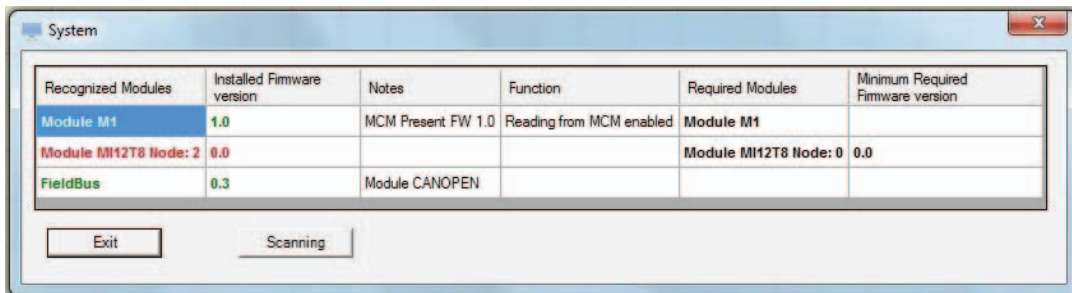

Figure 43

**Disconnecting System**

To disconnect the PC from M1 use the icon ; when the system is disconnected it is resetted and it starts with the sent project.

➔ If the system is not composed of all modules provided by the configuration, after the disconnection, M1 indicates the incongruity and does not starts. (See SIGNALS).

## MONITOR (I/O status in real time - textual)

To activate the monitor use the icon . (Password Required: level 1).  
A pop-up window will appear (in real time) with:

- Status of the inputs (when the object has two or more input connections to Mosaic, the MONITOR will show as active only the first), see the example in figure;
- Inputs Diagnostics;
- OSSD State;
- OSSD Diagnostics;
- Status of digital outputs;
- OUT TEST diagnostics.

Module	block	Type	INPUT	State	Input diagnostic	Module	OSSD	State	OSSD diagnostic	Module	Status	State	DiagOutT	Dig_out diagnostic
M1	1	Enable	IN1	OFF		M1	OSSD1	OFF			X		M1 T1	
			IN2				X				X		M1 T2	
							MO4 - 0	OSSD2	OFF		MO4 - 0	STATUS1	OFF	M1 T3
M1	2	Enable	IN4	OFF		MO4 - 0	OSSD3	OFF		MO4 - 0	STATUS2	OFF	M1 T4	
M1	3	Enable	IN5	OFF		MO4 - 0	OSSD4	OFF		MO4 - 0	STATUS3	OFF		
M1	4	Enable	IN6	OFF		MO4 - 0	OSSD5	OFF		MO4 - 0	STATUS4	OFF		
M1	5	Enable	IN7	OFF										
M1	6	Enable	IN8	OFF										

Figure 44 - textual monitor

## MONITOR (I/O status in real time - textual - graphic)

To activate/deactivate the monitor use the icon . (Password Required: level 1).  
The color of links (Figure 33) allows you to view the diagnostics (in real time) with:  
**RED = OFF**  
**GREEN = ON**  
**DASHED ORANGE = Connection Error**  
**DASHED RED = Pending enable (for example RESTART)**  
 Placing the mouse pointer over the link, you can display the diagnostics.

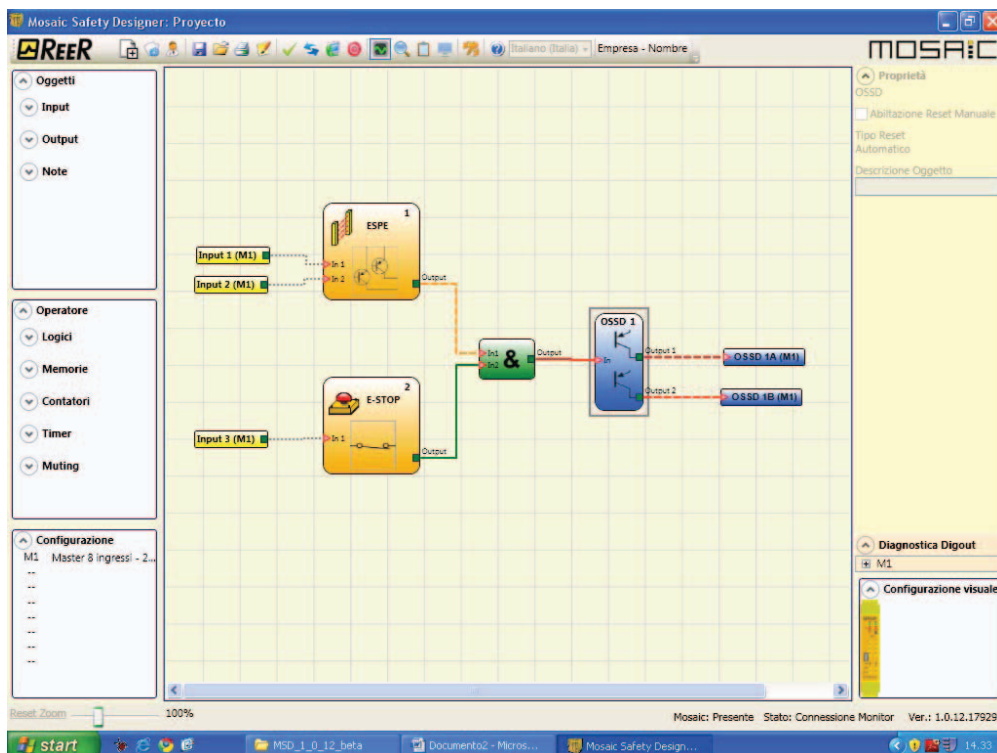

Figure 45 - graphic monitor

Password protection

The MSD requests a password in order to upload and save the project.

- ➔ The password entered as default must be modified to avoid manipulation (level 2 password) or so that the configuration loaded on Mosaic (level 1 password) is not visible.

Level 1 password

All operators using the M1 system must have a Level 1 PASSWORD.

This password allows only to view the LOG file, composition of the system and MONITOR in real time and upload operations.

The first time the system is initialised the operator must use the password "" (ENTER key).

Designers who know the level 2 password can enter a new level 1 password (alphanumerical, max 8 characters).

- ➔ Operators who know this password **are enabled** to upload (from M1 to PC), modify or save the project.

Level 2 password

Designers authorised to work on the creation of the project must know a Level 2 PASSWORD. The first time the system is initialised the operator must use the password "SAFEPASS" (all capital letters).

Designers who know the level 2 password can enter a new level 2 password (alphanumerical, max 8 characters).

- ➔ This password **enables** the project to be uploaded (from PC to M1), modified and saved. In other words, it allows total control of the PC => MOSAIC system.
- ➔ When a new project is UPLOADED the level 2 password could be changed.
- ➔ Should you forget either of these passwords, please contact Reer which will provide an unlock file (when the unlock file is saved in the right directory the icon 🗝️ will appear on the toolbar). When the icon is activated, the password level 1 and level 2 are restored to their original values. This password is only given to the designer and can only be used once.

Password Change

To activate the PASSWORD Change use icon 🗝️, after connecting with Level 2 Password. A window appears (Figure 46) allowing the choice of the new password; insert the old and new passwords in the appropriate fields (max 8 characters). Click OK.

At the end of the operation disconnect to restart the system.

If MCM is present the new password is also saved in it.

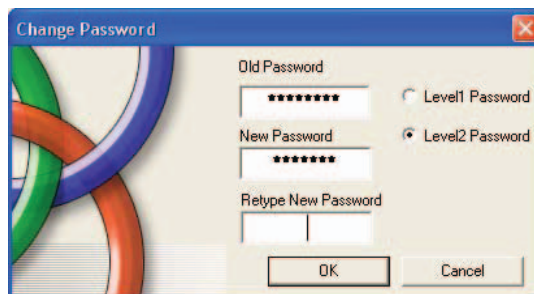

Figure 46

TESTING the system

**After validating and uploading the project to the M1 and connecting all the safety devices, you must test the system to verify its correct operation.**

This is done by forcing a change of status for each safety device connected to the MOSAIC to check that the status of the outputs actually changes. The following example is helpful for understanding the TEST procedure.

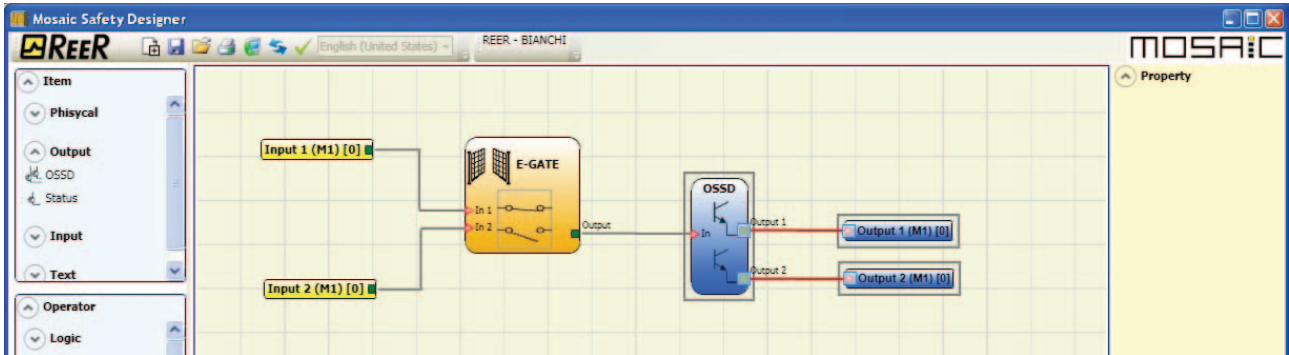
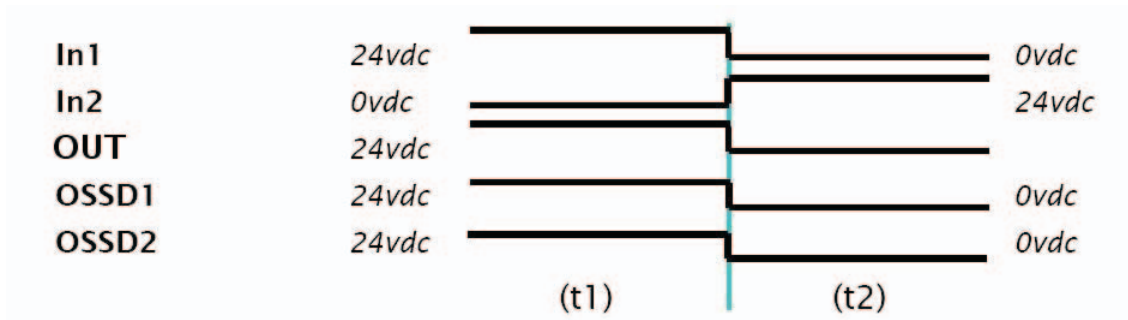

Figure 47

- (t1) In the normal operating condition (E-GATE closed) Input1 is closed, Input2 is open and the output of the E-GATE block is set to high logic level; in this mode the safety outputs (OSSD1/2) are active and the power supply to the relative terminals is 24VDC.
- (t2) When the E-GATE is **physically** opened, the condition of the inputs and thus of the outputs of the E-GATE block will change: (OUT= 0VDC--->24VDC); **the condition of the OSSD1- OSSD2 safety outputs will change from 24VDC to 0VDC.** If this change is detected the mobile E-GATE is connected correctly.



**For the correct installation of each external sensor/component refer to their installation manual.**

**This test must be performed for each safety component in the project.**

## OBJECT FUNCTION BLOCKS

### OUTPUT OBJECTS

#### OSSD (safety outputs)

The OSSD semiconductor safety outputs require no maintenance, Output1 and Output2 supply 24Vdc if the input is 1 (TRUE), whereas they supply 0Vdc if the input is 0 (FALSE).

➔ Each pair of OSSD has an entrance on RESTART\_FBK. This input must always be connected as described in paragraph RESTART\_FBK.

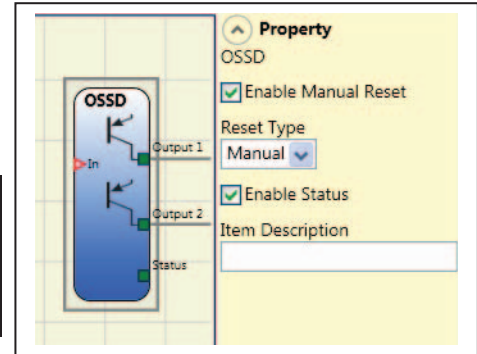

#### Parameters

**Manual reset:** If selected this enables the request to reset each time the input signal falls. Otherwise, enabling of the output directly follows the input conditions. There are two types of reset: Manual and Monitored. When Manual is selected the system only verifies the signal's transition from 0 to 1.

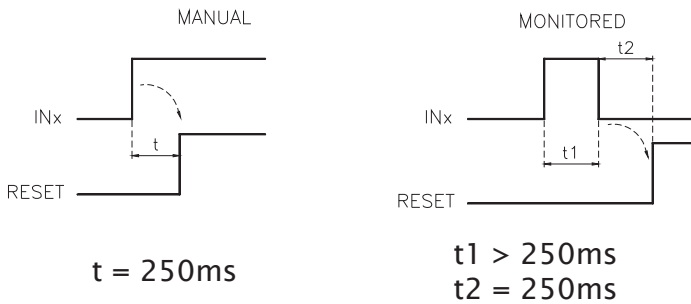

If Monitored is selected the double transition from 0 to 1 and then back to 0 is verified.

**Enable status:** If checked enables the connection of the current status of the OSSD with a STATUS.

#### STATUS (signal output)

STATUS output (NOT SAFETY OUTPUT) makes it possible to monitor any point on the diagram by connecting it to the input. The output returns 24Vdc if the input is 1 (TRUE), or 0Vdc if the input is 0 (FALSE).

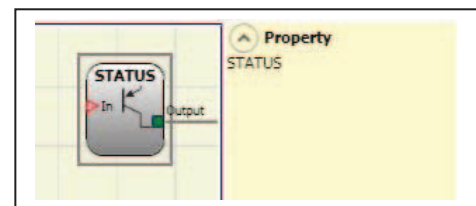

**WARNING:** The STATUS output is NOT a safety output.

#### FIELDBUS PROBE

Element that permits display of the status of any point of the scheme on the fieldbus. Up to 16 probes can be inserted and the bit on which status is represented must be entered for each. States are represented with 2 bytes on the fieldbus. (For more detailed information, consult the fieldbus manual on the MSD CD-ROM).

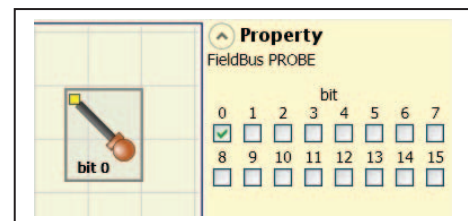

**WARNING:** the PROBE output is NOT a safety output

## RELAY

The Output relay is a N.O. relay output. Relay outputs are closed when the input *IN* is equal to 1 (TRUE), otherwise they are open (FALSE).

### Parameters

**Category** There is a choice of 3 different relay output categories:

**Category 1.** Outputs with single Category 1 relay. Each MOR4/S8 unit may have up to 4 of these outputs.

**Category 2.** Outputs with single Category 2 relay with OTE outputs. Each MOR4/S8 unit can have up to 4 of these outputs.

**OTE:** The OTE (Output Test Equipment) output is normally 1 (TRUE) except in the case of an internal error or a fault associated with feedback from the external contactors (FALSE).

**Category 4.** Outputs with two Category 4 relays. Each MOR4/S8 unit can have up to 2 of these outputs. With this output the relays are controlled in pairs.

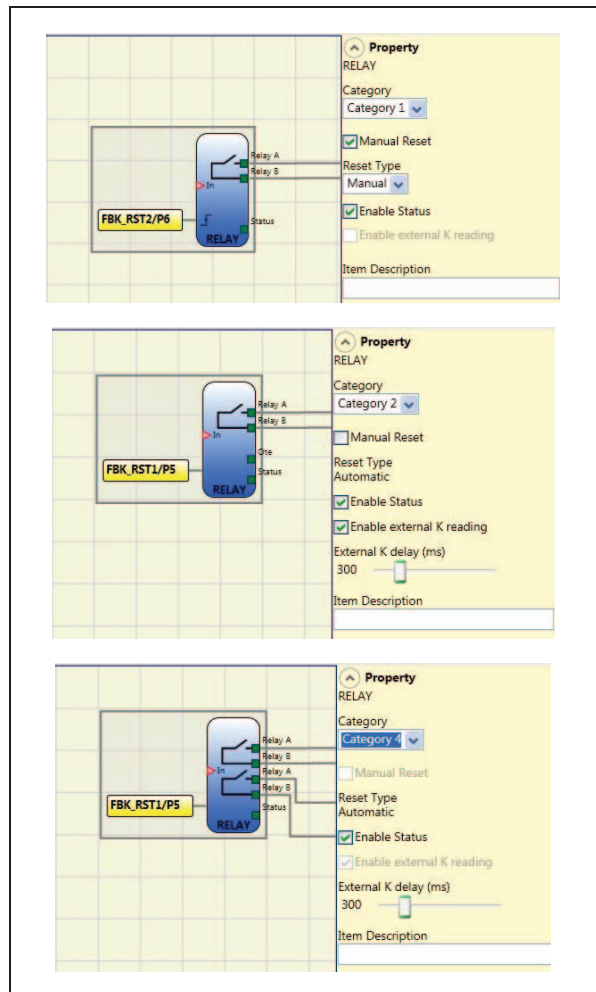

**Manual Reset:** If selected this enables the request to reset each time the IN input signal falls. Otherwise, the output is enabled directly according to the condition of the IN input.

There are two types of reset: Manual and Monitored. When Manual is selected the system only verifies the signal's transition from 0 to 1. If Monitored is selected, the double transition from 0 to 1 and then back to 0 is verified.

**Enable status:** If selected this enables the connection of the current status of the relay outputs to a STATUS.

**Enable reading of external K:** When this is selected it enables reading and verification of external contactor switching times:

- With Category 1 control of external contactors cannot be enabled.
- With Category 4 control of external contactors is mandatory (always enabled).

**External K delay (ms):** Select the Maximum delay the external contactors are allowed to introduce. This value can be used to check the maximum delay between switching of the internal relays and switching of the external contactors (during both activation and deactivation).

INPUT OBJECTS

E- STOP (emergency stop)

E-STOP function block verifies an emergency stop device inputs status. If the emergency stop button has been pressed the output is 0 (FALSE). If not the output is 1 (TRUE).

Parameters

Input type:

- Single NC - allows connection of one-way emergency stops
- Double NC - allows connection of two-way emergency stops .

*Manual reset:* If selected this enables the request to reset each time the emergency stop is activated. Otherwise, enabling of the output directly follows the input conditions.

There are two types of reset: Manual and Monitored. When Manual is selected the system only verifies the signal's transition from 0 to 1. If Monitored is selected the double transition from 0 to 1 and then back to 0 is verified.

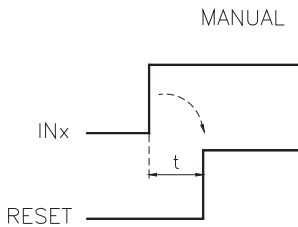
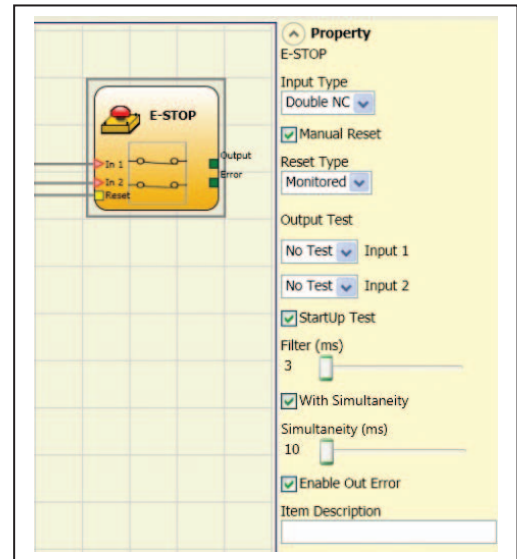

t = 250ms

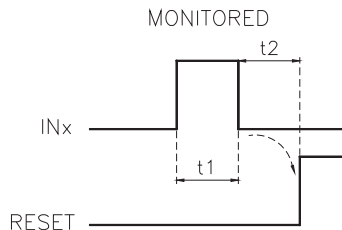

t1 > 250ms  
t2 = 250ms

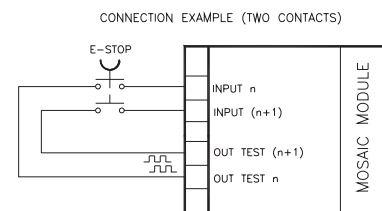
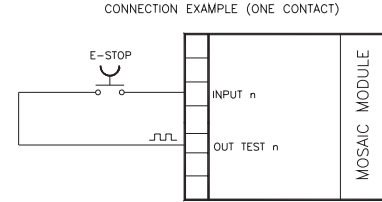

➔ **WARNING:** If the Manual Reset is active, a consecutive Input have to be used. Example : Input 1 and Input 2 are used for the fuctional block, then Input 3 have to be used for the Reset Input.

*Output test:* This is used to select which test output signals are to be sent to the emergency stop (mushroom pushbutton). This additional test makes it possible to detect and manage any short-circuits between the lines. This additional control permits detection and management of any short-circuits between the lines. To enable this control, the test output signals must be configured (amongst those available).

*Test at start-up:* If selected this enables the test at start-up of the external component (emergency stop). This test is performed by pressing and releasing the pushbutton to run a complete function test and enable the output. This test is only requested at machine start-up (when the unit is switched on).



**Filter (ms):** This is used to filter the signals coming from the emergency stop. The filter can be configured to between 3 and 250 ms and eliminates any bouncing on the contacts. The length of the filter affects the calculation of the unit's total response time.

**With Simultaneity:** If selected this activates the test to verify concurrent switching of the signals coming from the emergency stop.

**Simultaneity (ms):** This is only active if the previous parameter is enabled. It defines the maximum time (in msec) between the switching of two different signals from the emergency stop.

**Enable Error Out:** If selected reports a fault detected by the function block.

**Item description:** This allows a description of the component's function to be entered. The text is displayed in the top part of the symbol.

### E- GATE (safety gate device)

E-GATE function block verifies a mobile guard or safety gate device input status. If the mobile guard or safety gate is open, the output is 0 (FALSE). Otherwise the output is 1 (TRUE).

#### Parameters

##### Input type:

- Double NC - Allows connection of components with two NC contacts
- Double NC/NO - Allows connection of components with one NO contact and one NC.

**Enable reset:** If selected this enables the request to reset each time the mobile guard/safety gate is activated. Otherwise, enabling of the output directly follows the input conditions.

There are two types of reset: Manual and Monitored. When Manual is selected the system only verifies the signal's transition from 0 to 1. If Monitored is selected the double transition from 0 to 1 and then back to 0 is verified.

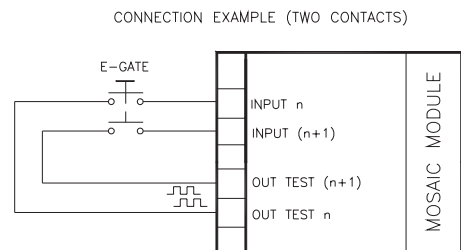
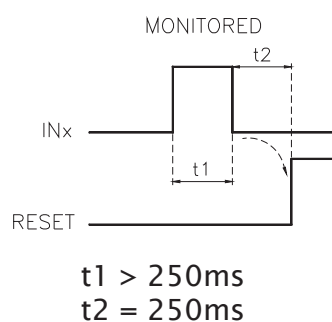
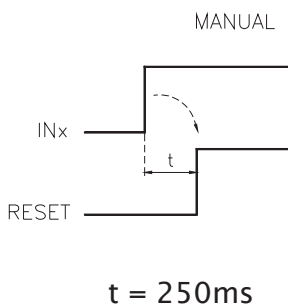
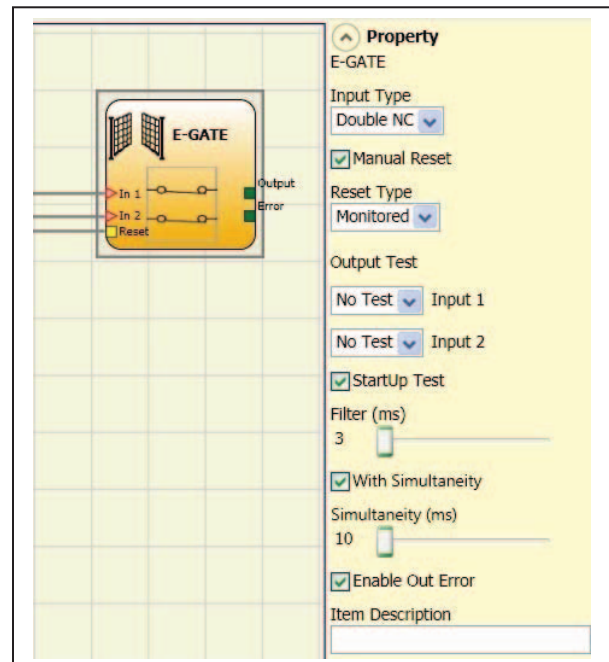

**➔ WARNING:** If the Manual Reset is active, a consecutive Input have to be used. Example : Input 1 and Input 2 are used for the fuctional block, then Input 3 have to be used for the Reset Input.

*Output test:* This is used to select which test output signals are to be sent to the component contacts. This additional control permits detection and management of any short-circuits between the lines. To enable this control, the test output signals must be configured (amongst those available).

*Test at start-up:* If selected this enables the test at start-up of the external component. This test is performed by opening the mobile guard or safety gate to run a complete function test and enable the output. This test is only requested at machine start-up (when the unit is switched on).

*Filter (ms):* This is used to filter the signals coming from the external contacts. The filter can be configured to between 3 and 250 ms and eliminates any bouncing on the contacts. The length of the filter affects the calculation of the unit's total response time.

*With Simultaneity:* If selected this activates the test to verify concurrent switching of the signals coming from the external contacts.

*Simultaneity (ms):* This is only active if the previous parameter is enabled. It defines the maximum time (in msecs) between the switching of two different signals from the external contacts.

*Enable Error Out:* If selected reports a fault detected by the function block.

*Item description:* This allows a description of the component's function to be entered. The text is displayed in the top part of the symbol.

## SINGLE E- GATE (safety gate device)

SINGLE E-GATE function block verifies a mobile guard or safety gate device input status. If the mobile guard or safety gate is open, the output is 0 (FALSE). Otherwise the output is 1 (TRUE).

### Parameters

**Enable reset:** If selected this enables the request to reset each time the mobile guard/safety gate is activated. Otherwise, enabling of the output directly follows the input conditions.

There are two types of reset: Manual and Monitored. When Manual is selected the system only verifies the signal's transition from 0 to 1. If Monitored is selected the double transition from 0 to 1 and then back to 0 is verified.

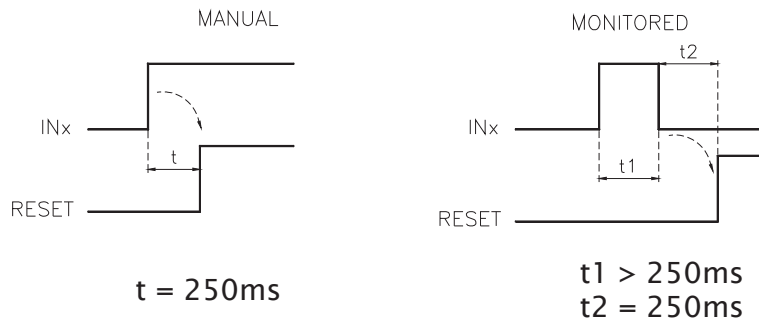
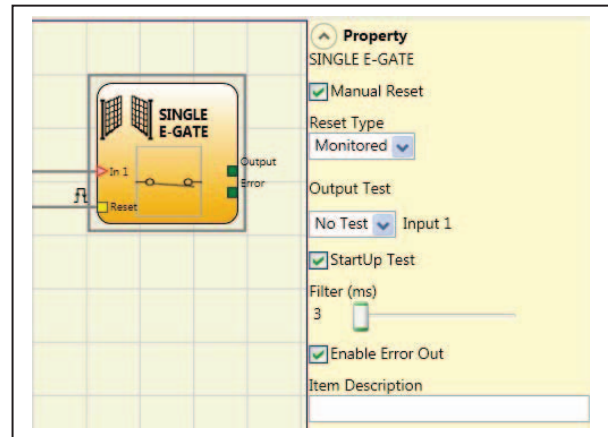

➔ **WARNING:** If the Manual Reset is active, a consecutive Input have to be used. Example : Input 1 and Input 2 are used for the fuctional block, then Input 3 have to be used for the Reset Input.

**Output test:** This is used to select which test output signals are to be sent to the component contacts. This additional control permits detection and management of any short-circuits between the lines. To enable this control, the test output signals must be configured (amongst those available).

**Test at start-up:** If selected this enables the test at start-up of the external component. This test is performed by opening the mobile guard or safety gate to run a complete function test and enable the output. This test is only requested at machine start-up (when the unit is switched on).

**Filter (ms):** This is used to filter the signals coming from the external contacts. The filter can be configured to between 3 and 250 ms and eliminates any bouncing on the contacts. The length of the filter affects the calculation of the unit's total response time.

**Enable Error Out:** If selected reports a fault detected by the function block.

**Item description:** This allows a description of the component's function to be entered. The text is displayed in the top part of the symbol.

## LOCK FEEDBACK

The function block LOCK FEEDBACK verifies the lock status of the guard lock device for mobile guard or safety gate. In the case where the inputs indicate that the guard is locked the Output will be 1 (TRUE). Otherwise the output is 0 (FALSE).

### Parameters

#### Input type

- Single NC - Allows connection of components with one NC contact;
- Double NC - Allows connection of components with two NC contacts.
- Double NC/NO - Allows connection of components with one NO contact and one NC.

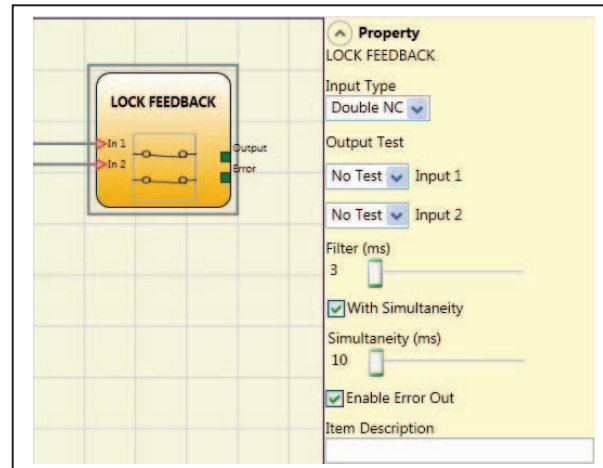

**Output test:** This is used to select which test output signals are to be sent to the component contacts. This additional control permits detection and management of any short-circuits between the lines. To enable this control, the test output signals must be configured (amongst those available).

**Filter (ms):** This is used to filter the signals coming from the external contacts. The filter can be configured to between 3 and 250 ms and eliminates any bouncing on the contacts. The length of the filter affects the calculation of the unit's total response time.

**With Simultaneity:** If selected this activates the test to verify concurrent switching of the signals coming from the external contacts.

**Simultaneity (ms):** This is only active if the previous parameter is enabled. It defines the maximum time (in msecs) between the switching of two different signals from the external contacts.

**Enable Error Out:** If selected reports a fault detected by the function block.

**Item description:** This allows a description of the component's function to be entered. The text is displayed in the top part of the symbol.

## ENABLE (enable key)

ENABLE function block verifies a manual key device Input status. If the key is not turned the output is 0 (FALSE). Otherwise the output is 1 (TRUE).

### Parameters

#### Input type

- Single NO - Allows connection of components with one NO contact;
- Double NO - Allows connection of components with two NO contacts.

**Enable reset:** If selected this enables the request to reset each time the command is activated. Otherwise, enabling of the output directly follows the input conditions.

There are two types of reset: Manual and Monitored. When Manual is selected the system only verifies the signal's transition from 0 to 1.

If Monitored is selected the double transition from 0 to 1 and then back to 0 is verified.

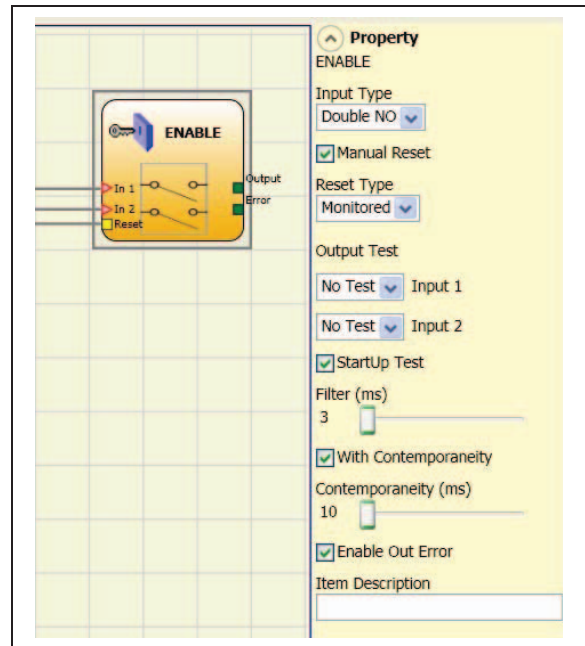

➔ **WARNING:** If the Manual Reset is active, a consecutive Input have to be used. Example : Input 1 and Input 2 are used for the functional block, then Input 3 have to be used for the Reset Input.

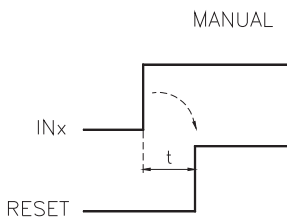

$$t = 250ms$$

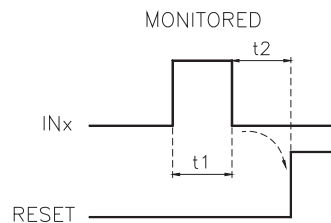

$$t1 > 250ms$$

$$t2 = 250ms$$

CONNECTION EXAMPLE (ONE CONTACT)

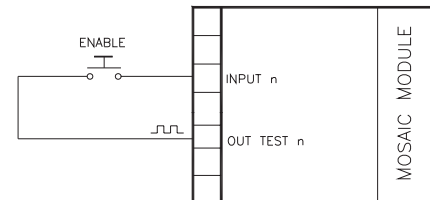

CONNECTION EXAMPLE (TWO CONTACTS)

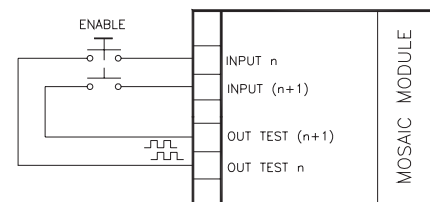

**Output test:** This is used to select which test output signals are to be sent to the component contacts. This additional control permits detection and management of any short-circuits between the lines. To enable this control, the test output signals must be configured (amongst those available).

**Test at start-up:** If selected this enables the test at start-up of the external component. This test is performed by opening and activating the enable key to run a complete

function test and enable the output. This test is only requested at machine start-up (when the unit is switched on).

*Filter (ms):* This is used to filter the signals coming from the external contacts. The filter can be configured to between 3 and 250 ms and eliminates any bouncing on the contacts. The length of the filter affects the calculation of the unit's total response time.

*With Simultaneity:* If selected this activates the test to verify concurrent switching of the signals coming from the external contacts.

*Simultaneity (ms):* This is only active if the previous parameter is enabled. It defines the maximum time (in msecs) between the switching of two different signals from the external contacts.

*Enable Error Out:* If selected reports a fault detected by the function block.

*Item description:* This allows a description of the component's function to be entered. The text is displayed in the top part of the symbol.

**ESPE (optoelectronic safety light curtain / laser scanner)**

ESPE function block verifies an optoelectronic safety light curtain (or laser scanner) inputs state. If the area protected by the light curtain is occupied, (light curtain outputs FALSE) the output is 0 (FALSE). Otherwise, with the area clear and outputs to 1 (TRUE) the output is 1 (TRUE).

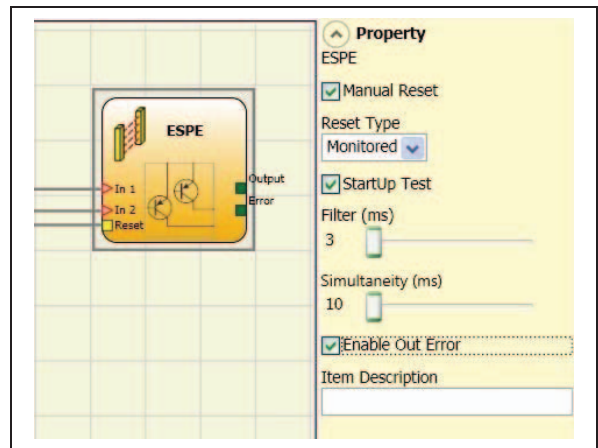

*Parameters*

*Enable reset:* If selected this enables the request to reset each time the area protected by the safety light curtain is occupied.

Otherwise, enabling of the output directly follows the input conditions.

There are two types of reset: Manual and Monitored. When Manual is selected the system only verifies the signal's transition from 0 to 1. If Monitored is selected the double transition from 0 to 1 and then back to 0 is verified.

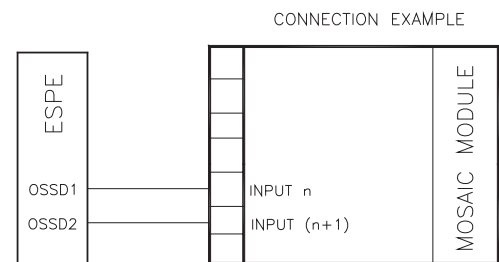
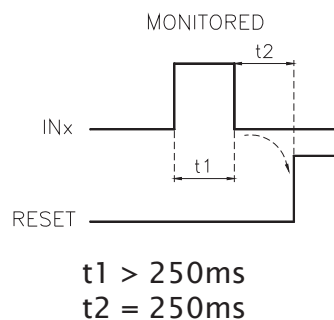
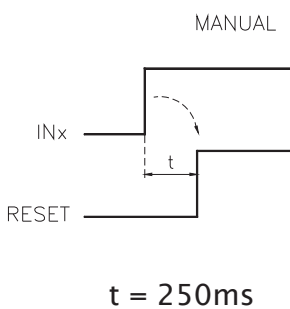

➔ **WARNING:** If the Manual Reset is active, a consecutive Input have to be used. Example : Input 1 and Input 2 are used for the fuctional block, then Input 3 have to be used for the Reset Input.

OUT TEST signals cannot be used in case of safety static output ESPE because the control is carried out from the ESPE.

**Test at start-up:** If selected this enables the test at start-up of the safety light curtain. This test is performed by occupying and clearing the area protected by the safety light curtain to run a complete function test and enable the output. This test is only requested at machine start-up (when the unit is switched on).

**Filter (ms):** This is used to filter the signals coming from the safety light curtain. The filter can be configured to between 3 and 250 ms and eliminates any bouncing on the contacts. The length of the filter affects the calculation of the unit's total response time.

**With Simultaneity:** If selected this activates the test to verify concurrent switching of the signals coming from the safety light curtain.

**Simultaneity (ms):** This is only active if the previous parameter is enabled. It defines the maximum time (in msec) between the switching of two different signals from the safety light curtain.

**Enable Error Out:** If selected reports a fault detected by the function block.

**Item description:** This allows a description of the component's function to be entered. The text is displayed in the top part of the symbol.

### FOOTSWITCH (safety pedal)

The FOOTSWITCH function block verifies the status of the inputs of a safety pedal device. If the pedal is not pressed the output is 0 (FALSE). Otherwise the output is 1 (TRUE).

#### Parameters

##### Input type:

- Single NC - Allows connection of pedals with one NC contact
- Single NO - Allows connection of pedals with one NO contact.
- Double NC - Allows connection of pedals with two NC contacts
- Double NC/NO - Allows connection of pedals with one NO contact and one NC.

**Manual reset:** If selected this enables the request to reset each time the safety pedal is activated. Otherwise, enabling of the output directly follows the input conditions.

There are two types of reset: Manual and Monitored. When Manual is selected the system only verifies the signal's transition from 0 to 1. If Monitored is selected the double transition from 0 to 1 and then back to 0 is verified.

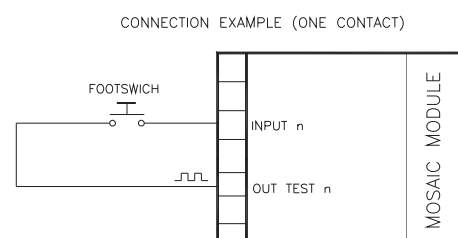
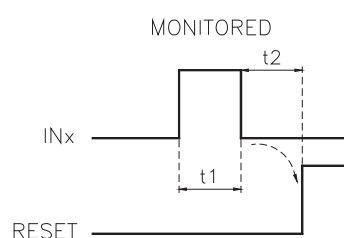
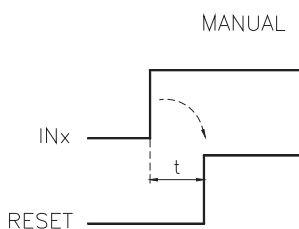
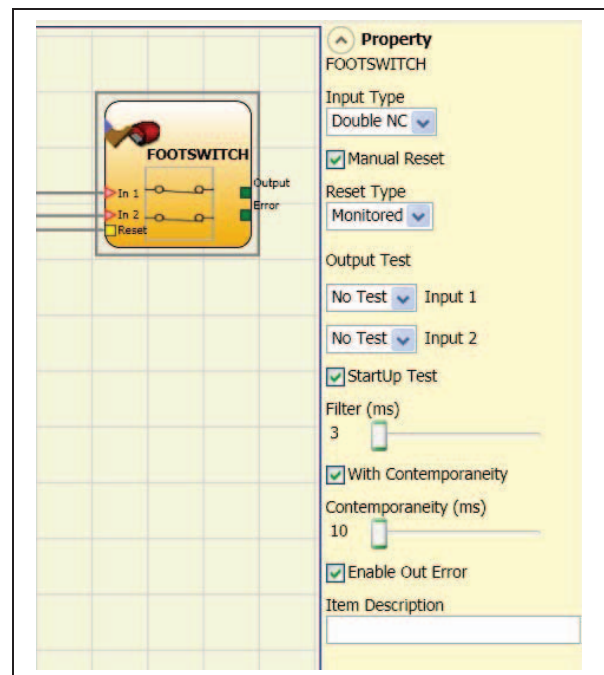

t = 250ms

t1 > 250ms  
t2 = 250ms

➔ **WARNING:** If the Manual Reset is active, a consecutive Input have to be used. Example : Input 1 and Input 2 are used for the fuctional block, then Input 3 have to be used for the Reset Input.

*Output test:* This is used to select which test output signals are to be sent to the component contacts. This additional control permits detection and management of any short-circuits between the lines. To enable this control, the test output signals must be configured (amongst those available).

*Test at start-up:* If selected this enables the test at start-up of the external component. This test is performed by pressing and releasing the footswitch to run a complete function test and enable the output. This test is only requested at machine start-up (when the unit is switched on).

*Filter (ms):* This is used to filter the signals coming from the external contacts. The filter can be configured to between 3 and 250 ms and eliminates any bouncing on the contacts. The length of the filter affects the calculation of the unit's total response time.

*With Simultaneity:* If selected this activates the test to verify concurrent switching of the signals coming from the external contacts.

*Simultaneity (ms):* This is only active if the previous parameter is enabled. It defines the maximum time (in msec) between the switching of two different signals from the external contacts.

*Enable Error Out:* If selected reports a fault detected by the function block.

*Item description:* This allows a description of the component's function to be entered. The text is displayed in the top part of the symbol.

**MOD- SEL (safety selector)**

The MOD-SEL function block verifies the status of the inputs from a mode selector (up to 4 inputs): If only one input is 1 (TRUE) the corresponding output is also 1 (TRUE). In all other cases, and thus when all inputs are 0 (FALSE) or more than one input is 1 (TRUE) all the outputs are 0 (FALSE).

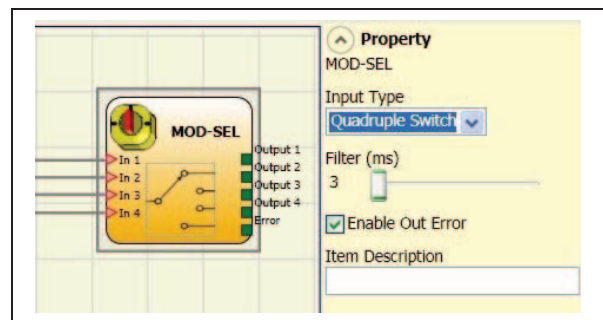

*Parameters*

*Input type:*

- Double selector - Allows connection of two-way mode selectors.
- Triple selector - Allows connection of three-way mode selectors.
- Quadruple selector - Allows connection of four-way mode selectors.

*Filter (ms):* This is used to filter the signals coming from the mode selector. The filter can be configured to between 3 and 250 ms and eliminates any bouncing on the contacts. The length of the filter affects the calculation of the unit's total response time.

*Enable Error Out:* If selected reports a fault detected by the function block.

*Item description:* This allows a description of the component's function to be entered. The text is displayed in the top part of the symbol.



## PHOTOCELL (safety photocell)

The PHOTOCELL function block verifies the status of the inputs of an optoelectronic safety photocell. If the beam of the photocell is occupied (photocell output FALSE) the output is 0 (FALSE). Otherwise with the beam clear and an output of 1 (TRUE) the output is 1 (TRUE).

### Parameters

**Manual reset:** If selected this enables the request to reset each time safety photocell is activated. Otherwise, enabling of the output directly follows the input conditions.

There are two types of reset: Manual and Monitored. When Manual is selected the system only verifies the signal's transition from 0 to 1. If Monitored is selected the double transition from 0 to 1 and then back to 0 is verified.

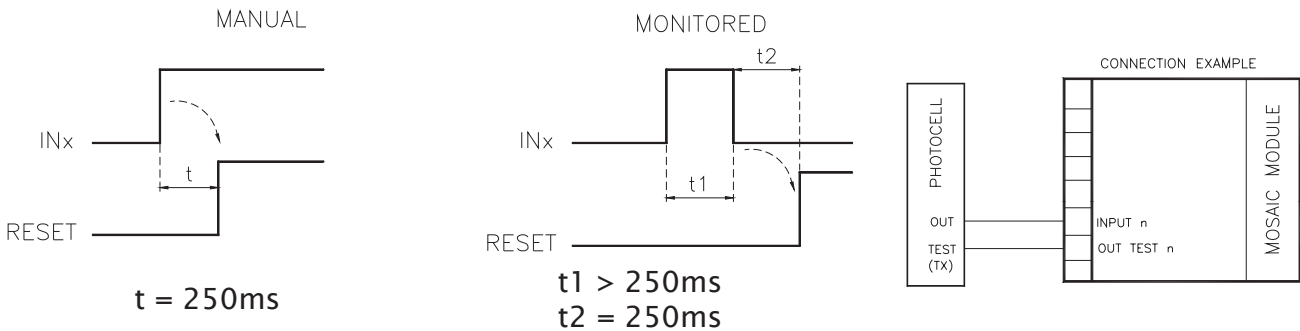
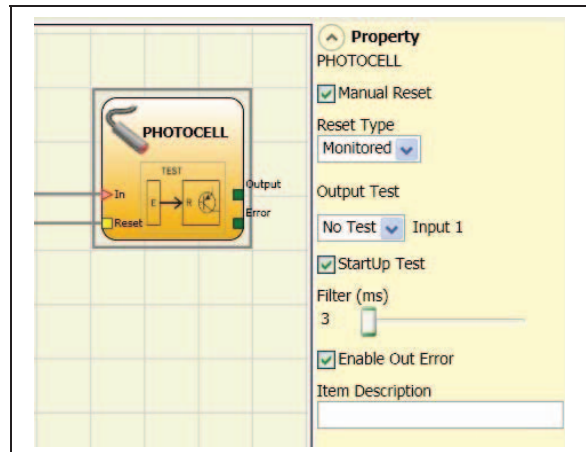

➔ **WARNING:** If the Manual Reset is active, a consecutive Input have to be used. Example : Input 1 is used for the functional block, then Input 2 have to be used for the Reset Input.

**Output test:** This is used to select which test output are to be sent to the photocell test input. This additional control permits detection and management of any short-circuits between the lines. To enable this control, the test output signals must be configured (amongst those available).

**Test at start-up:** If selected this enables the test at start-up of the external component. This test is performed by occupying and clearing the photocell to run a complete function test and enable the output. This test is only requested at machine start-up (when the unit is switched on).

**Filter (ms):** This is used to filter the signals coming from the external contacts. The filter can be configured to between 3 and 250 ms and eliminates any bouncing on the contacts. The length of the filter affects the calculation of the unit's total response time.

**Enable Error Out:** If selected reports a fault detected by the function block.

**Item description:** This allows a description of the component's function to be entered. The text is displayed in the top part of the symbol.

## TWO- HAND (bimanual control)

The TWO HAND function block verifies the status of the inputs of a two hand control switch. Only if both the press-buttons are pressed within 500 msec the output is 1 (TRUE). Otherwise the output is 0 (FALSE).

### Input type:

- Double NO - Allows connection of two-hand switch with one NO contact for each button (EN 574 III A).
- Quadruple NC-NO - Allows connection of two-hand switch with a double NO/NC contact for each button (EN 574 III C).

**Output test:** This is used to select which test output signals are to be sent to the component contacts. This additional control permits detection and management of any short-circuits between the lines. To enable this control, the test output signals must be configured (amongst those available).

**Test at start-up:** If selected this enables the test at start-up of the external component. This test is performed by pressing the two buttons (within 500 msec) and releasing them to run a complete function test and enable the output. This test is only requested at machine start-up (when the unit is switched on).

**Filter (ms):** This is used to filter the signals coming from the mode selector. The filter can be configured to between 3 and 250 ms and eliminates any bouncing on the contacts. The length of the filter affects the calculation of the unit's total response time.

**Enable Error Out:** If selected reports a fault detected by the function block.

**Item description:** This allows a description of the component's function to be entered. The text is displayed in the top part of the symbol.

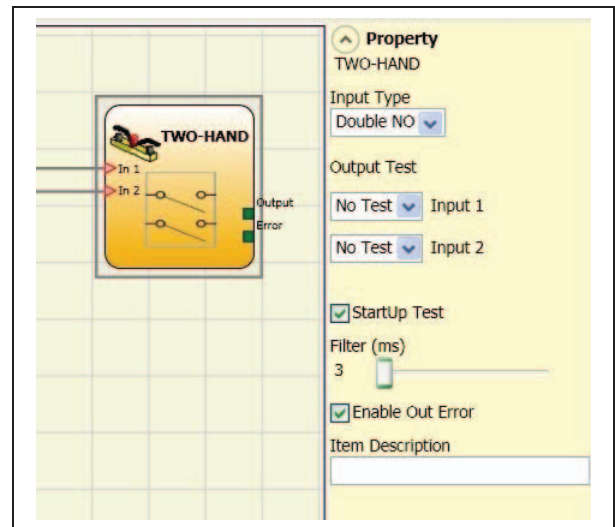

## SENSOR

The SENSOR function block verifies the status of the input of a sensor (not a safety sensor). If the beam of the sensor is occupied (sensor output FALSE) the output is 0 (FALSE). Otherwise, with the beam clear and an output of 1 (TRUE) then the output is 1 (TRUE).

### Parameters

**Manual reset:** If selected this enables the request to reset each time the area protected by the sensor is occupied. Otherwise, enabling of the output directly follows the input conditions.

There are two types of reset: Manual and Monitored. When Manual is selected the system only verifies the signal's transition from 0 to 1. If Monitored is selected the double transition from 0 to 1 and then back to 0 is verified.

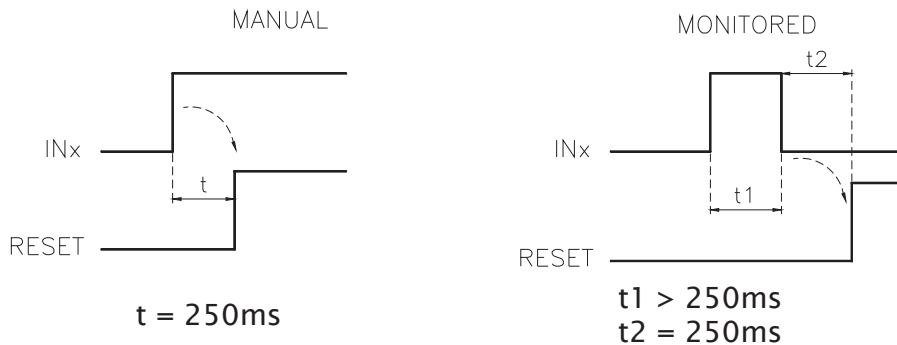
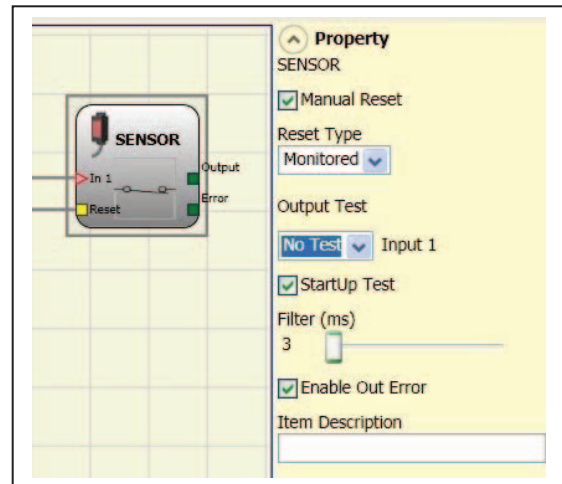

➔ **WARNING:** If the Manual Reset is active, a consecutive Input have to be used. Example : Input 1 is used for the fuctional block, then Input 2 have to be used for the Reset Input.

**Output test:** This is used to select which test output signals are to be sent to the sensor. This additional control permits detection and management of any short-circuits between the lines. To enable this control, the test output signals must be configured (amongst those available).

**Test at start-up:** If selected this enables the test at start-up of the sensor. This test is performed by occupying and clearing the area protected by the sensor to run a complete function test and enable the output. This test is only requested at machine start-up (when the unit is switched on).

**Filter (ms):** This is used to filter the signals coming from the sensor. The filter can be configured to between 3 and 250 ms and eliminates any bouncing on the contacts. The length of the filter affects the calculation of the unit's total response time.

**Enable Error Out:** If selected reports a fault detected by the function block.

**Item description:** This allows a description of the component's function to be entered. The text is displayed in the top part of the symbol.

**S- MAT (safety mat)**

The S-MAT function block verifies the status of the inputs of a safety mat. If a person stands on the mat the output is 0 (FALSE). Otherwise, with the mat clear, the output is 1 (TRUE).

*Parameters*

**Manual reset:** If selected this enables the request to reset each time the mobile guard/safety gate is activated. Otherwise, enabling of the output directly follows the input conditions.

There are two types of reset: Manual and Monitored. When Manual is selected the system only verifies the signal's transition from 0 to 1. If Monitored is selected the double transition from 0 to 1 and then back to 0 is verified.

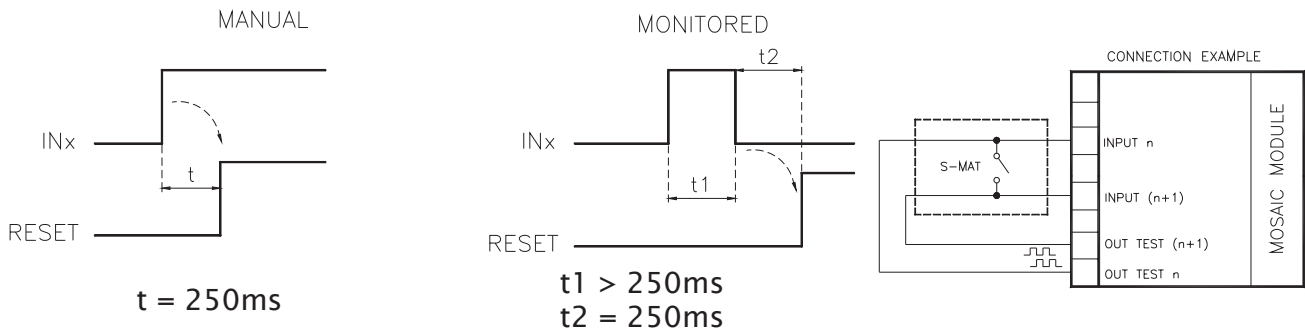
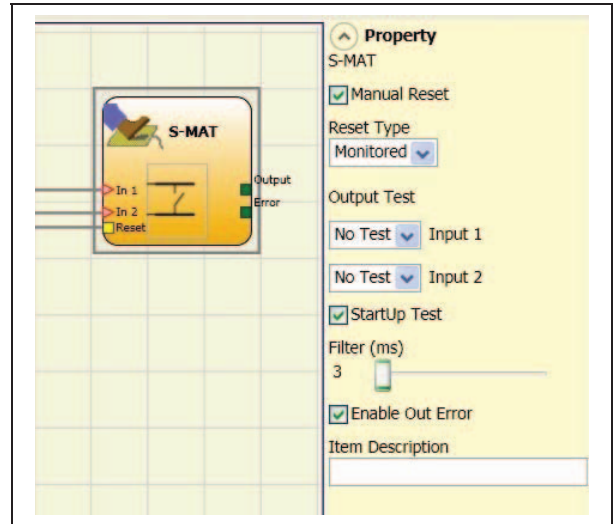

- ➔ If the Manual Reset is active, a consecutive Input have to be used. Example : Input 1 and Input 2 are used for the fuctional block, then Input 3 have to be used for the Reset Input.
- ➔ Each output OUT TEST can be connected to only one input S-MAT (it is not allowed parallel connection of 2 inputs).
- ➔ The function block S-MAT can not be used with 2-wire components and termination resistance.

**Output test:** This is used to select which test output signals are to be sent to the s-mat contact. This additional control permits detection and management of any short-circuits between the lines. To enable this control, the test output signals must be configured (amongst those available). Test signals are mandatory.

**Test at start-up:** If selected this enables the test at start-up of the external component. This test is performed by pressing and releasing the safety mat to run a complete function test and enable the output. This test is only requested at machine start-up (when the unit is switched on).

**Filter (ms):** This is used to filter the signals coming from the external contacts. The filter can be configured to between 3 and 250 ms and eliminates any bouncing on the contacts. The length of the filter affects the calculation of the unit's total response time.

**Enable Error Out:** If selected reports a fault detected by the function block.

*Item description:* This allows a description of the component's function to be entered. The text is displayed in the top part of the symbol.

**SWITCH**

SWITCH function block verifies the input status of a pushbutton or switch (NOT SAFETY SWITCHES). If the pushbutton is pressed the output is 1 (TRUE). Otherwise, the output is 0 (FALSE).

*Parameters*

*Manual reset:* If selected this enables the request to reset each time the device is activated. Otherwise, enabling of the output directly follows the input conditions.

There are two types of reset: Manual and Monitored. When Manual is selected the system only verifies the signal's transition from 0 to 1.

If Monitored is selected the double transition from 0 to 1 and then back to 0 is verified.

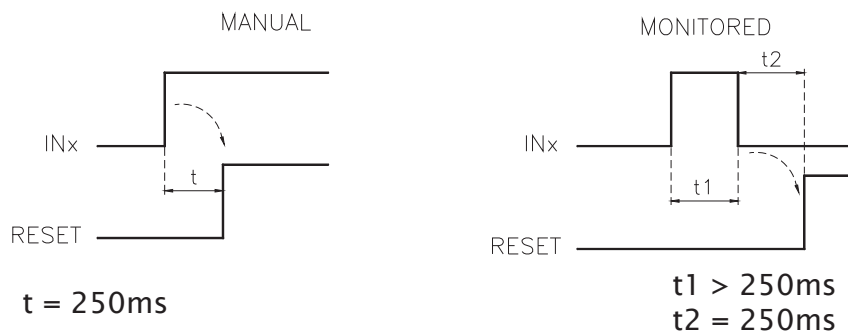
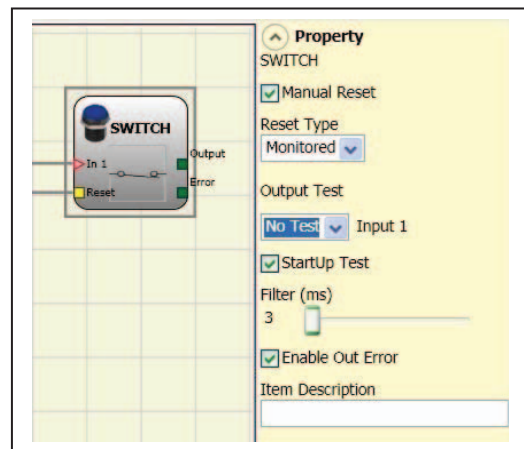

➔ **WARNING:** If the Manual Reset is active, a consecutive Input have to be used. Example : Input 1 is used for the fuctional block, then Input 2 have to be used for the Reset Input.

*Output test:* This is used to select which test output signals are to be sent to the switch. This additional control permits detection and management of any short-circuits between the lines. To enable this control, the test output signals must be configured (amongst those available).

*Test at start-up:* If selected this enables the test at start-up of the switch. This test is performed by opening and closing the switch contact to run a complete function test and enable the output. This test is only requested at machine start-up (when the unit is switched on).

*Filter (ms):* This is used to filter the signals coming from the switch. The filter can be configured to between 3 and 250ms and eliminates any bouncing on the contacts. The length of the filter affects the calculation of the unit's total response time.

*Enable Error Out:* If selected reports a fault detected by the function block.

*Item description:* This allows a description of the component's function to be entered. The text is displayed in the top part of the symbol.

**ENABLING GRIP SWITCH**

The ENABLING GRIP functional block checks the status of the In<sub>x</sub> inputs of an enabling grip. If this is not gripped (position 1) or is gripped completely (position 3), the OUTPUT will be 0 (FALSE). If it is gripped to middle position (position 2), the OUTPUT will be 1 (TRUE). Refer to truth tables at the bottom of the page.

➔ The ENABLING GRIP functional block requires that the assigned module has a minimum Firmware version as Table below:

<b>M1</b>	<b>MI8O2</b>	<b>MI8</b>	<b>MI16</b>	<b>MI12</b>
<b>1.0</b>	<b>0.4</b>	<b>0.4</b>	<b>0.4</b>	<b>0.0</b>

*Parameters*

*Type of inputs:*

- Double NO - Permits connection of an enabling grip with 2 NO contacts.
- Double NO+1NC - Permits connection of an enabling grip switch with 2 NO contacts + 1 NC contact.

*Test outputs:* Permits selection of the test output signals to be sent to the enabling grip. This additional control permits detection and management of any short-circuits between the lines. To enable this control, the test output signals must be configured (amongst those available).

*Power-on test:* If selected, enables the power-on test of the external component (Enabling Grip). To run the test, the device must be gripped and released to carry out a complete functional check and enable the Output terminal. This control is required only at machine start-up (power-on of the module).

*Simultaneity (ms):* always active. Determines that maximum permissible time (msec) between switching of the various signals from the external contacts of the device.

*Filter (ms):* Permits filtering of signals from the device control. This filter can be set to between 3 and 250 ms and eliminates any rebounds on the contacts. The duration of the filter affects calculation of module total response time.

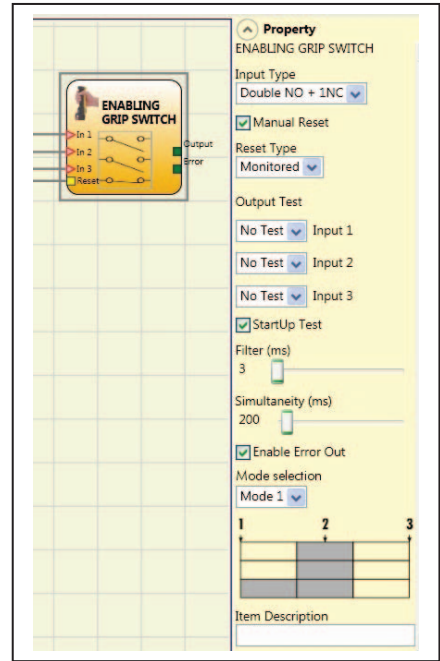
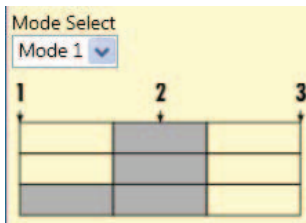

Table mode 1 (device 2NO + 1NC)



POSITION 1: enabling grip fully released  
 POSITION 2: enabling grip pressed to middle position  
 POSITION 3: enabling grip fully pressed

(only with 2NO+1NC)

	Position		
Input	1	2	3
IN1	0	1	0
IN2	0	1	0
IN3	1	1	0
OUT	0	1	0

Table mode 1 (device 2NO + 1NC)

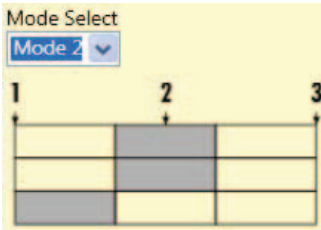

POSITION 1: enabling grip fully released  
 POSITION 2: enabling grip pressed to middle position  
 POSITION 3: enabling grip fully pressed

Input	Position		
	1	Input	1
IN1	0	1	0
IN2	0	1	0
IN3	1	0	0
OUT	0	1	0

(only with 1NO+1NC)

**Enable Error Out:** If selected reports a fault detected by the function block.

**Item description:** Permits insertion of a descriptive text of the function of the component. This text will be displayed in the top part of the symbol.

**TESTABLE SAFETY DEVICE**

The TESTABLE SAFETY DEVICE functional block checks the status of the Inx inputs of a single or double safety sensor, both NO and NC. Refer to the tables below to check type of sensor and behaviour.

(single NC)

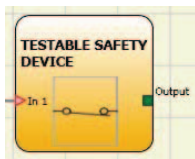

IN1	OUT
0	0
1	1

(single NO)

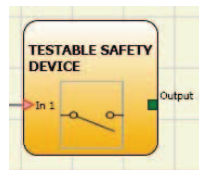

IN1	OUT
0	0
1	1

(double NC)

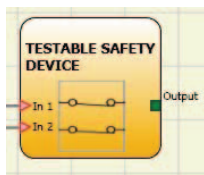

IN1	IN2	OUT	Simultaneity error *
0	0	0	-
0	1	0	X
1	0	0	X
1	1	1	-

(double NC-NO)

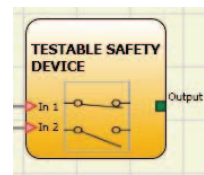

IN1	IN2	OUT	Simultaneity error *
0	0	0	X
0	1	0	-
1	0	1	-
1	1	0	X

\* **Simultaneity error** = the maximum time between switching of the single contacts has been exceeded.

**Parameters**

**Manual Reset:** If selected, enables the reset request after each activation of the device. Otherwise, enabling of the output follows directly the conditions of the inputs. Reset may be of two types: Manual and Monitored. Selecting the Manual option, only transition of the signal from 0 to 1 is checked. If Monitored is selected, double transition from 0 to 1 and return to 0 is checked.

English

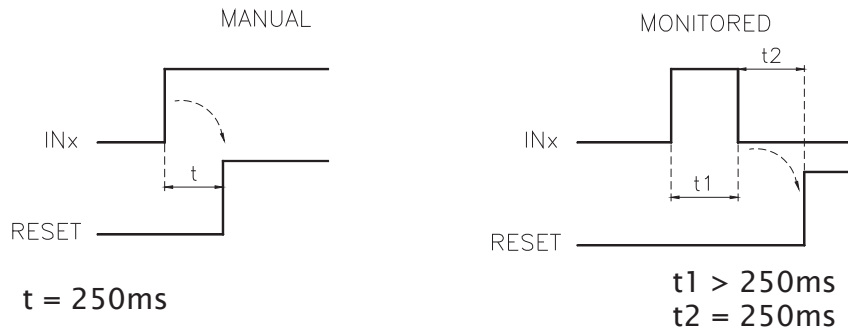

➔ **WARNING:** if Reset is enabled, the input consecutive to those used by the functional block must be used. For example: If inputs 1 and 2 are used for the functional block, input 3 must be used for Reset.

*Power-on test:* If selected, enables the power-on test of the device. This test requires activation and de-activation of the device in order to run a complete functional check and enable the Output terminal. This test is required only at machine start-up (power-on of the module).

*Filter (ms):* Permits filtering of signals from the device. This filter can be set to between 3 and 250 ms and eliminates any rebounds on the contacts. The duration of the filter affects calculation of module total response time.

*With simultaneity:* If selected, activates control of simultaneity between switching of signals from the device.

*Simultaneity (ms):* Is active only if the previous parameter is enabled. Determines the maximum permissible time (msec) between switching of two different signals from the sensor.

*Enable Error Out:* If selected reports a fault detected by the function block.

*Item description:* Permits insertion of a descriptive text of the function of the component. This text will be displayed in the top part of the symbol.



## SOLID STATE DEVICE

The SOLID STATE DEVICE functional block checks the status of the Inx inputs. If the inputs are at 24VDC, the Output will be 1 (TRUE), otherwise the OUTPUT will be 0 (FALSE).

### Parameters

**Manual Reset:** If selected, enables the reset request after each safety function activation. Otherwise, enabling of the output follows directly the conditions of the inputs. Reset may be of two types: Manual and Monitored. Selecting the Manual option, only transition of the signal from 0 to 1 is checked. If Monitored is selected, double transition from 0 to 1 and return to 0 is checked.

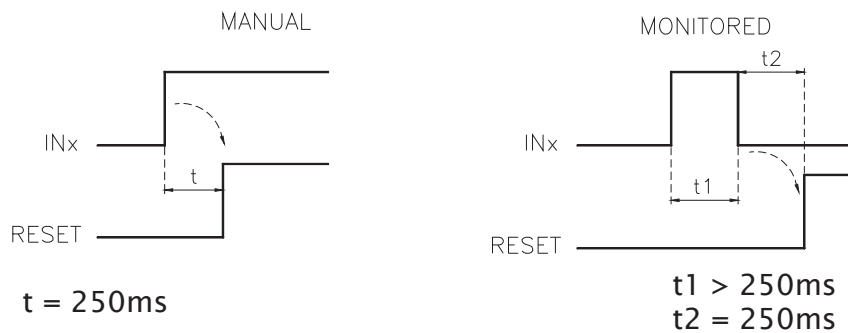
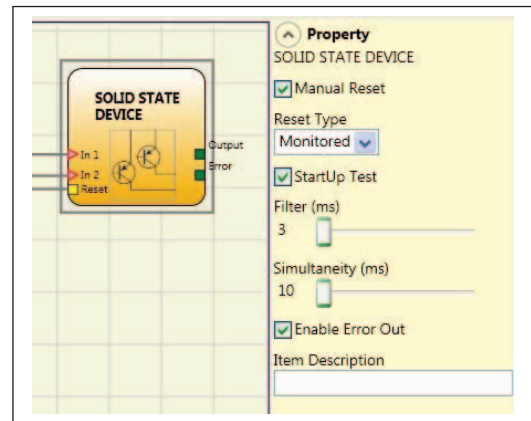

**WARNING:** if Reset is enabled, the input consecutive to those used by the functional block must be used. For example: if inputs 1 and 2 are used for the functional block, input 3 must be used for Reset.

**Power-on test:** If selected, enables the power-on test of the safety device. This test requires activation and de-activation of the device in order to run a complete functional check and enable the Output terminal. This test is required only at machine start-up (power-on of the module)

**Filter (ms):** Permits filtering of signals from the safety device. This filter can be set to between 3 and 250 ms and eliminates any rebounds on the contacts. The duration of the filter affects calculation of module total response time.

**Simultaneity (ms):** Determines that maximum permissible time (msec) between switching of two different signals from the device.

**Enable Error Out:** If selected reports a fault detected by the function block.

**Item description:** Permits insertion of a descriptive text of the function of the component. This text will be displayed in the top part of the symbol.

**FIELDBUS INPUT**

Element that permits insertion of a non-safety input whose status is modified via the fieldbus.

Up to 8 virtual inputs can be inserted and the bit on which status is to be modified must be selected for each.

They are represented with one byte on the fieldbus. *(For more detailed information, consult the fieldbus manual on the MSD CD-ROM).*

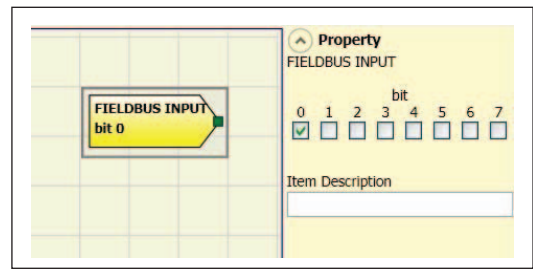

**WARNING:** the FIELDBUS INPUT is NOT a safety input.

**LL0- LL1**

These allow a predefined logical level to be entered on a component's input.

LL0 -> logical level 0

LL1 -> logical level 1

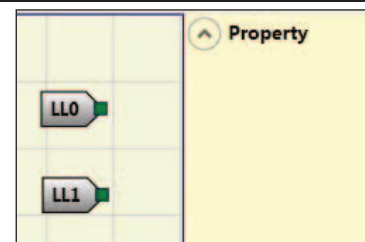

**IMPORTANT:** LL0 and LL1 cannot be used to disable the logical ports in the diagram.

**COMMENTS**

This allows a description to be entered and placed in any point of the diagram.

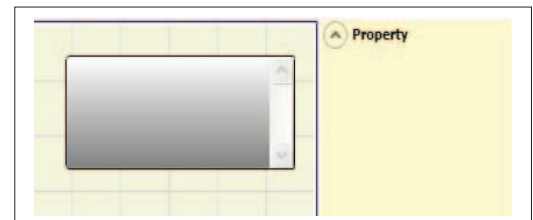

**TITLE**

Automatically adds the name of the manufacturer, the designer, the project name and the CRC.

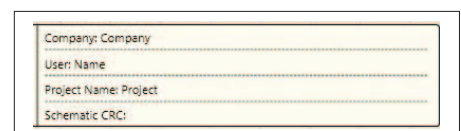

## SPEED CONTROL TYPE FUNCTION BLOCKS

### SPEED CONTROL

The **Speed Control** function block monitors the speed of a device generating an output 0 (FALSE) when the measured speed exceeds a predetermined threshold. In the case in which the speed is below the predetermined threshold the output will be 1 (TRUE).

#### Parameters

**Axis type:** It defines the type of axis controlled by the device. It will be Linear in the case of a translation and will be Rotary in the case of motion around an axis.

**Sensor Type:** In the event that the previous parameter is Linear, the Sensor Type defines the type of sensor connected to the module inputs. It can be Rotary (e.g. shaft encoder) or Linear (e.g. optical array). This choice allows to define the following parameters.

**Measuring device:** It defines the type of sensor(s) used. The possible choices are:

- Encoder
- Proximity
- Encoder+Proximity
- Proximity1+ Proximity2
- Encoder1+ Encoder2

**Enable direction:** Enabling this parameter, the DIR output is enabled on the function block. This output will be 1 (TRUE) when the axis rotates Counterclockwise and will be 0 (FALSE) when the axis rotates Clockwise

**Direction decision:** It defines the direction of rotation for which the set thresholds are made active. The possible choices are:

- Bidirectional
- Clockwise
- Counterclockwise

If Bidirectional is selected, the excess of the set threshold is detected whether the axis rotates clockwise or counterclockwise. Selecting Clockwise or Counterclockwise, this is detected only when the axis rotates in the selected direction.

**Threshold number:** It allows you to enter the number of thresholds for the maximum value of speed. Changing this value will increase/decrease the number of thresholds that can be entered from a minimum of 1 to a maximum of 4. In the case of thresholds greater than 1, the input pins for the selection of the specific threshold will appear in the lower part of the function block.

**Pitch:** If the Axis Type chosen was linear, this field allows you to enter the sensor pitch to obtain a conversion between sensor revolutions and distance travelled.

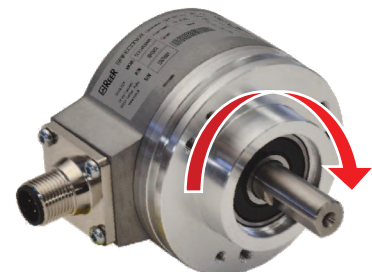
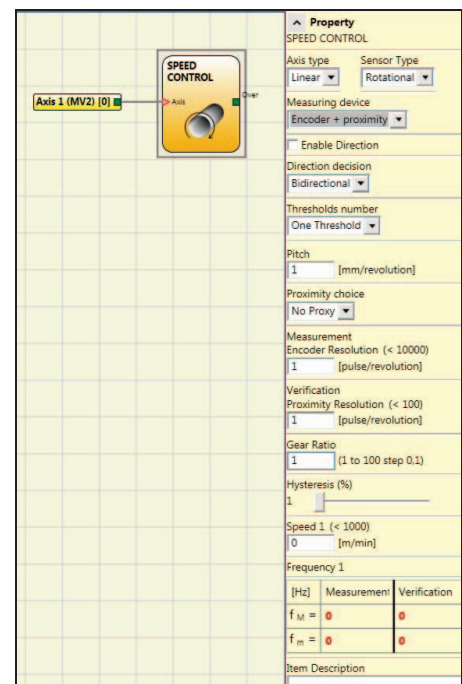

Example of CLOCKWISE axis rotation

2 threshold settings

In1	Threshold no.
0	Speed 1
1	Speed 2

4 threshold settings

In2	In1	Threshold no.
0	0	Speed 1
0	1	Speed 2
1	0	Speed 3
1	1	Speed 4

**Proximity choice:** It allows you to choose the type of proximity sensor from PNP, NPN, Normally Open (NA) and Normally Closed (NC), with 3 or 4 wires:

- No Proxy
- PNP 3-wire NC
- PNP 3-wire NO
- NPN 3-wire NO
- NPN 3-wire NC
- PNP 4-wire NC/NO
- NPN 4-wire NC/NO
- PNP/NPN 4-wire NC/NC
- PNP/NPN 4-wire NO/NO

**Measurement:** Enter in this field the number of pulses/revolution (in the case of rotary sensor) or µm/pulse (linear sensor) relating to the sensor used

**Verification:** Enter in this field the number of pulses/revolution (in the case of rotary sensor) or µm/pulse (linear sensor) relating to the second sensor used.

**Gear Ratio:** This parameter is active if there are two sensors on the selected axis. This parameter allows you to enter the ratio between the two sensors. If both sensors are on the same moving parts, the ratio will be 1 otherwise the number corresponding to the report must be entered. E.g. there are an encoder and a proximity switch, and the latter is on a moving part that (due to a gear reduction ratio) rotates at twice the speed of the encoder. Therefore, this value must be set at 2.

**Hysteresis (%):** It represents the percentage hysteresis value below which the speed change is filtered. Enter a value other than 1 to avoid continuous switching as the input changes.

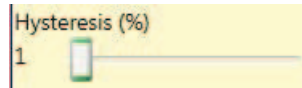

**Speed 1, 2, 3, 4:** Enter in this field the maximum speed value above which the function block output (OVER) will be 0 (FALSE). If the measured speed is less than the set value, the function block output (OVER) will be 1 (TRUE).

**Frequency:** It shows the maximum calculated frequency values fM and fm (decreased by the hysteresis set). If the displayed value is GREEN, the calculation of frequency gave a positive result. If the displayed value is RED, it is necessary to change the parameters given in the following formulas.

- Rotary axis, rotary sensor. The frequency obtained is:

$$f[\text{Hz}] = \frac{\text{rpm}[\text{rev}/\text{min}]}{60} * \text{Resolution}[\text{pulses}/\text{rev}]$$

- Linear axis, rotary sensor. The frequency obtained is:

$$f[\text{Hz}] = \frac{\text{speed}[\text{m}/\text{min}] * 1000}{60 * \text{pitch}[\text{mm}/\text{rev}]} * \text{Resolution}[\text{pulses}/\text{rev}]$$

- Linear axis, linear sensor. The frequency obtained is:

$$f[\text{Hz}] = \frac{\text{speed}[\text{mm}/\text{s}] * 1000}{\text{Resolution}[\mu\text{m}/\text{pulse}]}$$

- Hysteresis. To be changed only if: fM=green; fm=red

**KEY:**

*f* = frequency  
*Rpm* = rotational speed  
*Resolution* = measurement  
*Speed* = linear speed  
*Pitch* = sensor pitch

## WINDOW SPEED CONTROL

The **Window Speed Control** function block monitors the speed of a device, generating the Zero to 1 (TRUE) output when the speed is within a prefixed range.

### Parameters

**Axis type:** It defines the type of axis controlled by the device. It will be Linear in the case of a translation and will be Rotary in the case of motion around an axis.

**Sensor Type:** In the event that the previous parameter is Linear, the Sensor Type defines the type of sensor connected to the module inputs. It can be Rotary (e.g. shaft encoder) or Linear (e.g. optical array). This choice allows to define the following parameters.

**Measuring device:** It defines the type of sensor(s) used. The possible choices are:

- Encoder
- Proximity
- Encoder+Proximity
- Proximity1+ Proximity2
- Encoder1+ Encoder2

**Pitch:** If the Axis Type chosen was linear, this field allows you to enter the sensor pitch to obtain a conversion between sensor revolutions and distance travelled.

**Proximity choice:** It allows you to choose the type of proximity sensor from PNP, NPN, Normally Open (NO) and Normally Closed (NC), with 3 or 4 wires:

**Measurement:** Enter in this field the number of pulses/revolution (in the case of rotary sensor) or  $\mu\text{m}/\text{pulse}$  (linear sensor) relating to the sensor used.

**Verification:** Enter in this field the number of pulses/revolution (in the case of rotary sensor) or  $\mu\text{m}/\text{pulse}$  (linear sensor) relating to the second sensor used.

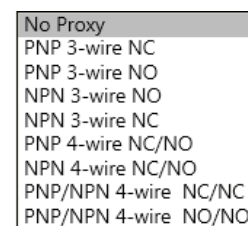
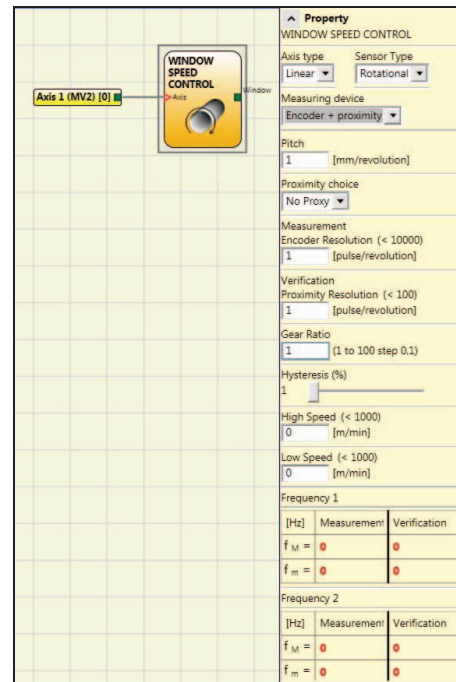

Proximity choice

**Gear Ratio:** This parameter is active if there are two sensors on the selected axis. This parameter allows you to enter the ratio between the two sensors. If both sensors are on the same moving parts, the ratio will be 1 otherwise the number corresponding to the report must be entered. E.g. there are an encoder and a proximity switch, and the latter is on a moving part that (due to a gear reduction ratio) rotates at twice the speed of the encoder. Therefore, this value must be set at 2.

**Hysteresis (%):** It represents the percentage hysteresis value below which the speed change is filtered. Enter a value other than 1 to avoid continuous switching as the input changes.

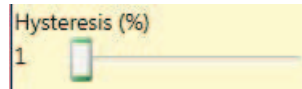

**High speed:**

Enter in this field the maximum speed value above which the output of the function block (WINDOW) will be 0 (FALSE). If the measured speed is less than the set value, the output (WINDOW) of the function block will be 1 (TRUE).

**Low speed:**

Enter in this field the minimum speed value below which the output of the function block (WINDOW) will be 0 (FALSE). If the measured speed is more than the set value, the output (WINDOW) of the function block will be 1 (TRUE).

**Frequency:** It shows the maximum calculated frequency values  $f_M$  and  $f_m$  (decreased by the hysteresis set). If the displayed value is GREEN, the calculation of frequency gave a positive result.

If the displayed value is RED, it is necessary to change the parameters given in the following formulas.

1. Rotary axis, rotary sensor. The frequency obtained is:

$$f[\text{Hz}] = \frac{\text{rpm}[\text{rev}/\text{min}]}{60} * \text{Resolution}[\text{pulses}/\text{rev}]$$

2. Linear axis, rotary sensor. The frequency obtained is:

$$f[\text{Hz}] = \frac{\text{speed}[\text{m}/\text{min}] * 1000}{60 * \text{pitch}[\text{mm}/\text{rev}]} * \text{Resolution}[\text{pulses}/\text{rev}]$$

3. Linear axis, linear sensor. The frequency obtained is:

$$f[\text{Hz}] = \frac{\text{speed}[\text{mm}/\text{s}] * 1000}{\text{Resolution}[\mu\text{m}/\text{pulse}]}$$

4. Hysteresis. To be changed only if:  $f_M$ =green;  $f_m$ =red

**KEY:**

$f$  = frequency  
*Rpm* = rotational speed  
*Resolution* = measurement  
*Speed* = linear speed  
*Pitch* = sensor pitch

## STAND STILL

The **StandStill** function block monitors the speed of a device, generating the Zero to 1 (TRUE) output when the speed is lower than a selected value.

### Parameters

**Axis type:** It defines the type of axis controlled by the device. It will be Linear in the case of a translation and will be Rotary in the case of motion around an axis.

**Sensor Type:** In the event that the previous parameter is Linear, the Sensor Type defines the type of sensor connected to the module inputs. It can be Rotary (e.g. shaft encoder) or Linear (e.g. optical array). This choice allows to define the following parameters.

**Measuring device:** It defines the type of sensor(s) used. The possible choices are:

- Encoder
- Proximity
- Encoder+Proximity
- Proximity1 + Proximity2
- Encoder1+ Encoder2

**Pitch:** If the Axis Type chosen was linear, this field allows you to enter the sensor pitch to obtain a conversion between sensor revolutions and distance travelled.

**Proximity choice:** It allows you to choose the type of proximity sensor from PNP, NPN, Normally Open (NA) and Normally Closed (NC), with 3 or 4 wires:

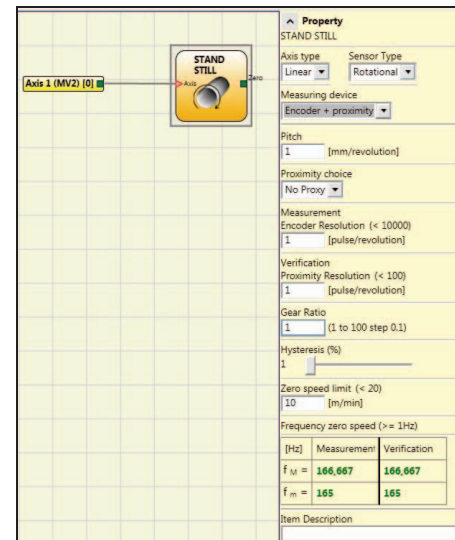

- No Proxy
- PNP 3-wire NC
- PNP 3-wire NO
- NPN 3-wire NO
- NPN 3-wire NC
- PNP 4-wire NC/NO
- NPN 4-wire NC/NO
- PNP/NPN 4-wire NC/NC
- PNP/NPN 4-wire NO/NO

Proximity choice

**Measurement:** Enter in this field the number of pulses/revolution (in the case of rotary sensor) or  $\mu\text{m}/\text{pulse}$  (linear sensor) relating to the sensor used

**Verification:** Enter in this field the number of pulses/revolution (in the case of rotary sensor) or  $\mu\text{m}/\text{pulse}$  (linear sensor) relating to the second sensor used.

**Gear Ratio:** This parameter is active if there are two sensors on the selected axis. This parameter allows you to enter the ratio between the two sensors. If both sensors are on the same moving parts, the ratio will be 1 otherwise the number corresponding to the report must be entered. E.g. there are an encoder and a proximity switch, and the latter is on a moving part that (due to a gear reduction ratio) rotates at twice the speed of the encoder. Therefore, this value must be set at 2.

**Hysteresis (%):** It represents the percentage hysteresis value below which the speed change is filtered. Enter a value other than 1 to avoid continuous switching as the input changes.

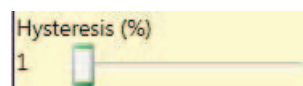

**Zero speed limit:**

Enter in this field the maximum speed value above which the output of the function block (ZERO) will be 0 (FALSE). If the measured speed is less than the set value, the output (ZERO) of the function block will be 1 (TRUE).

**Frequency zero speed:** It shows the maximum calculated frequency values  $f_M$  and  $f_m$  (decreased by the hysteresis set). If the displayed value is GREEN, the calculation of frequency gave a positive result.

If the displayed value is RED, it is necessary to change the parameters given in the following formulas.

1. Rotary axis, rotary sensor. The frequency obtained is:

$$f[\text{Hz}] = \frac{\text{rpm}[\text{rev}/\text{min}]}{60} * \text{Resolution}[\text{pulses}/\text{rev}]$$

2. Linear axis, rotary sensor. The frequency obtained is:

$$f[\text{Hz}] = \frac{\text{speed}[\text{m}/\text{min}] * 1000}{60 * \text{pitch}[\text{mm}/\text{rev}]} * \text{Resolution}[\text{pulses}/\text{rev}]$$

3. Linear axis, linear sensor. The frequency obtained is:

$$f[\text{Hz}] = \frac{\text{speed}[\text{mm}/\text{s}] * 1000}{\text{Resolution}[\mu\text{m}/\text{pulse}]}$$

4. Hysteresis. To be changed only if:  $f_M$ =green;  $f_m$ =red

**KEY:**

$f$  = frequency  
 $Rpm$  = rotational speed  
 $Resolution$  = measurement  
 $Speed$  = linear speed  
 $Pitch$  = sensor pitch



## STAND STILL AND SPEED CONTROL

The **StandStill and Speed Control** function block monitors the speed of a device, generating the Zero to 1 (TRUE) output when the speed is lower than a selected value. In addition, it generates the Over = 0 (FALSE) output if the measured speed exceeds a predetermined threshold.

### Parameters

**Axis type:** It defines the type of axis controlled by the device. It will be Linear in the case of a translation and will be Rotary in the case of motion around an axis.

**Sensor Type:** In the event that the previous parameter is Linear, the Sensor Type defines the type of sensor connected to the module inputs. It can be Rotary (e.g. shaft encoder) or Linear (e.g. optical array). This choice allows to define the following parameters.

**Measuring device:** It defines the type of sensor(s) used. The possible choices are:

- Encoder
- Proximity
- Encoder+Proximity
- Proximity1+ Proximity2
- Encoder1+ Encoder2

**Enable direction:** Enabling this parameter, the DIR output is enabled on the function block. This output will be 1 (TRUE) when the axis rotates Counterclockwise and will be 0 (FALSE) when the axis rotates Clockwise.

**Direction decision:** It defines the direction of rotation for which the set thresholds are made active. The possible choices are:

- Bidirectional
- Clockwise
- Counterclockwise

If Bidirectional is selected, the excess of the set threshold is detected whether the axis rotates clockwise or counterclockwise. Selecting Clockwise or Counterclockwise, this is detected only when the axis rotates in the selected direction.

**Threshold number:** It allows you to enter the number of thresholds for the maximum value of speed. Changing this value will increase/decrease the number of thresholds that can be entered from a minimum of 1 to a maximum of 4. In the case of thresholds greater than 1, the input pins for the selection of the specific threshold will appear in the lower part of the function block.

**Pitch:** If the Axis Type chosen was linear, this field allows you to enter the sensor pitch to obtain a conversion between sensor revolutions and distance travelled.

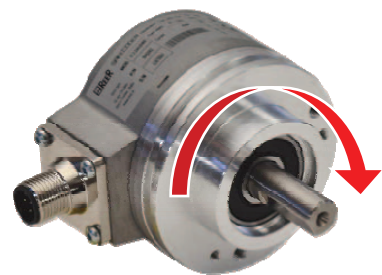
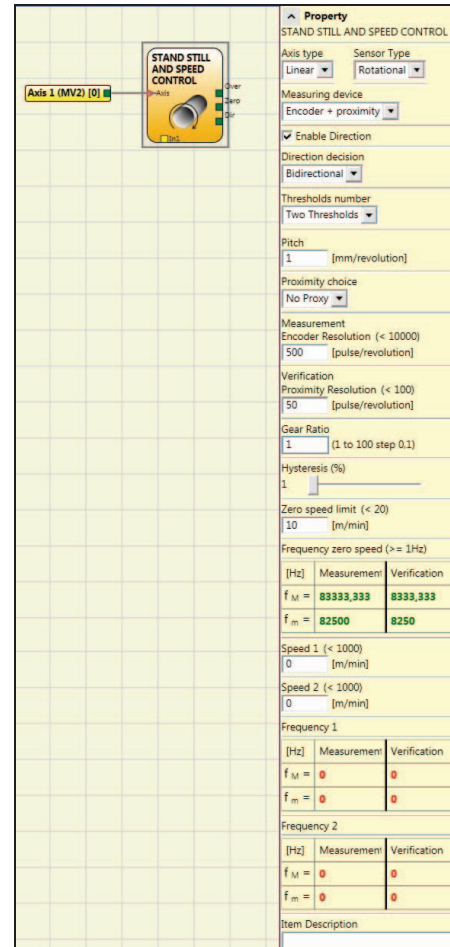

Example of CLOCKWISE axis rotation

2 threshold settings

In1	Threshold no.
0	Speed 1
1	Speed 2

4 threshold settings

In2	In1	Threshold no.
0	0	Speed 1
0	1	Speed 2
1	0	Speed 3
1	1	Speed 4

**Proximity choice:** It allows you to choose the type of proximity sensor from PNP, NPN, Normally Open (NA) and Normally Closed (NC), with 3 or 4 wires:

No Proxy
PNP 3-wire NC
PNP 3-wire NO
NPN 3-wire NO
NPN 3-wire NC
PNP 4-wire NC/NO
NPN 4-wire NC/NO
PNP/NPN 4-wire NC/NC
PNP/NPN 4-wire NO/NO

**Measurement:** Enter in this field the number of pulses/revolution (in the case of rotary sensor) or µm/pulse (linear sensor) relating to the sensor used

**Verification:** Enter in this field the number of pulses/revolution (in the case of rotary sensor) or µm/pulse (linear sensor) relating to the second sensor used.

**Gear Ratio:** This parameter is active if there are two sensors on the selected axis. This parameter allows you to enter the ratio between the two sensors. If both sensors are on the same moving parts, the ratio will be 1 otherwise the number corresponding to the report must be entered. E.g. there are an encoder and a proximity switch, and the latter is on a moving part that (due to a gear reduction ratio) rotates at twice the speed of the encoder. Therefore, this value must be set at 2.

**Hysteresis (%):** It represents the percentage hysteresis value below which the speed change is filtered. Enter a value other than 1 to avoid continuous switching as the input changes.

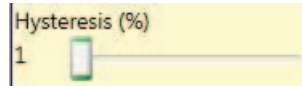

**Zero speed limit:**

Enter in this field the maximum speed value above which the output of the function block (ZERO) will be 0 (FALSE). If the measured speed is less than the set value, the output (ZERO) of the function block will be 1 (TRUE).

**Speed 1, 2, 3, 4:** Enter in this field the maximum speed value above which the function block output (OVER) will be 0 (FALSE). If the measured speed is less than the set value, the function block output (OVER) will be 1 (TRUE).

**Frequency zero speed/Frequency1/ Frequency2:** It shows the maximum calculated frequency values  $f_m$  and  $f_m$  (decreased by the hysteresis set). If the displayed value is GREEN, the calculation of frequency gave a positive result. If the displayed value is RED, it is necessary to change the parameters given in the following formulas.

1. Rotary axis, rotary sensor. The frequency obtained is:

$$f[\text{Hz}] = \frac{\text{rpm}[\text{rev}/\text{min}]}{60} * \text{Resolution}[\text{pulses}/\text{rev}]$$

2. Linear axis, rotary sensor. The frequency obtained is:

$$f[\text{Hz}] = \frac{\text{speed}[\text{m}/\text{min}] * 1000}{60 * \text{pitch}[\text{mm}/\text{rev}]} * \text{Resolution}[\text{pulses}/\text{rev}]$$

3. Linear axis, linear sensor. The frequency obtained is:

$$f[\text{Hz}] = \frac{\text{speed}[\text{mm}/\text{s}] * 1000}{\text{Resolution}[\mu\text{m}/\text{pulse}]}$$

4. Hysteresis. To be changed only if:  $f_m$ =green;  $f_m$ =red

**KEY:**

*f* = frequency  
*Rpm* = rotational speed  
*Resolution* = measurement  
*Speed* = linear speed  
*Pitch* = sensor pitch

## OPERATOR FUNCTION BLOCKS

All the input of these operators could be inverted (logical NOT). It could be done clicking with the right mouse key on the input to be inverted. A little circle will be showed on the inverted input. To cancel the inversion, simply click another time on the same input pin.

➔ The maximum number of user blocks is 64.

### LOGICAL OPERATORS

#### AND

Logical AND returns an output of 1 (TRUE) if all the inputs are 1 (TRUE).

In1	In2	Inx	Out
0	0	0	0
1	0	0	0
0	1	0	0
1	1	0	0
0	0	1	0
1	0	1	0
0	1	1	0
1	1	1	1

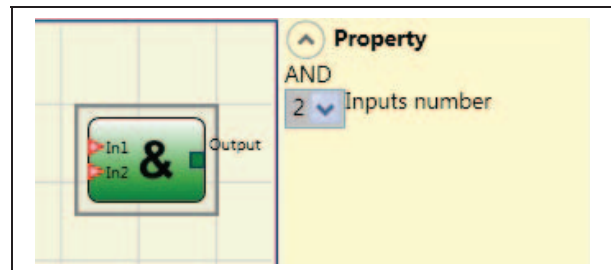

#### Parameters

*Number of inputs:* this is used to set between 2 and 8 inputs.

#### NAND

Logical NAND returns an output of 0 (FALSE) if all the inputs are 1 (TRUE).

In1	In2	Inx	Out
0	0	0	1
1	0	0	1
0	1	0	1
1	1	0	1
0	0	1	1
1	0	1	1
0	1	1	1
1	1	1	0

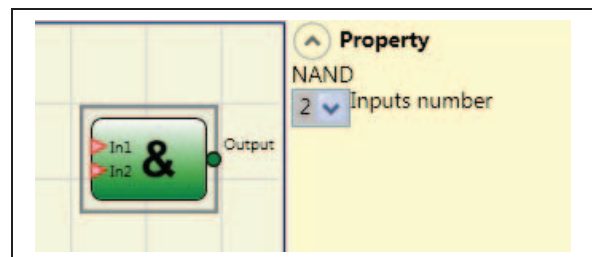

#### Parameters

*Number of inputs:* this is used to set between 2 and 8 inputs.

**NOT**

Logical NOT inverts the logical status of the input.

In	Out
0	1
1	0

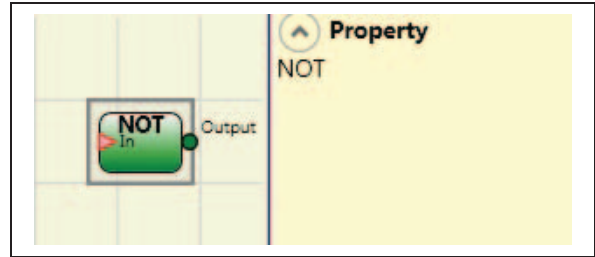

**OR**

Logical OR returns an output of 1 (TRUE) if at least one of the inputs is 1 (TRUE).

In <sub>1</sub>	In <sub>2</sub>	In <sub>x</sub>	Out
0	0	0	0
1	0	0	1
0	1	0	1
1	1	0	1
0	0	1	1
1	0	1	1
0	1	1	1
1	1	1	1

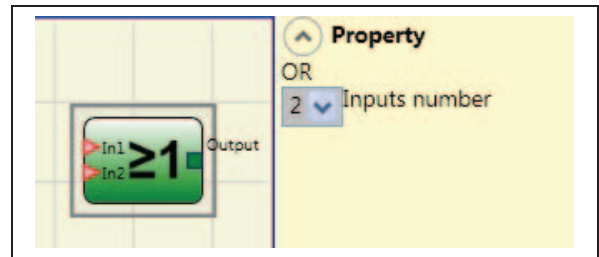

*Parameters*

*Number of inputs:* this is used to set between 2 and 8 inputs.

**NOR**

Logical NOR returns an output of 0 (FALSE) if at least one of the inputs is 1 (TRUE).

In <sub>1</sub>	In <sub>2</sub>	In <sub>x</sub>	Out
0	0	0	1
1	0	0	0
0	1	0	0
1	1	0	0
0	0	1	0
1	0	1	0
0	1	1	0
1	1	1	0

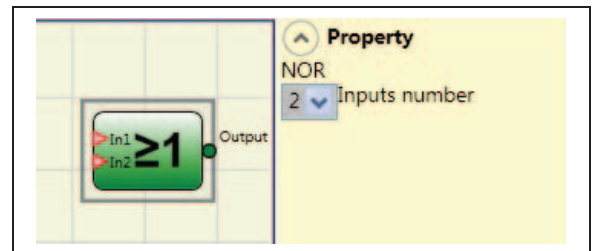

*Parameters*

*Number of inputs:* this is used to set between 2 and 8 inputs.

## XOR

Logical XOR returns an output 0 (FALSE) if the input's number at 1 (TRUE) is even or the inputs are all 0 (FALSE).

In1	In2	Inx	Out
0	0	0	0
1	0	0	1
0	1	0	1
1	1	0	0
0	0	1	1
1	0	1	0
0	1	1	0
1	1	1	1

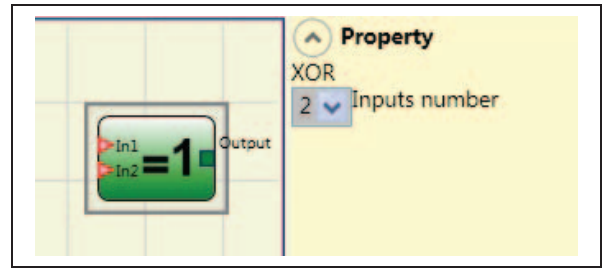

### Parameters

*Number of inputs:* this is used to set between 2 and 8 inputs.

## XNOR

Logical XNOR returns an output 1 (TRUE) if the input's number at 1 (TRUE) is even or the inputs are all 0 (FALSE).

In1	In2	Inx	Out
0	0	0	1
1	0	0	0
0	1	0	0
1	1	0	1
0	0	1	0
1	0	1	1
0	1	1	1
1	1	1	0

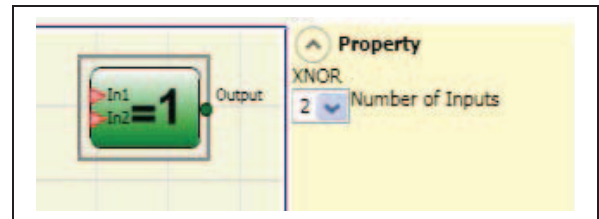

### Parameters

*Number of inputs:* this is used to set between 2 and 8 inputs.

## MULTIPLEXER

Logical MULTIPLEXER forwards the signal of the inputs to the output according to the Sel selection. If the SEL1÷SEL4 have only one bit set, the selected *In n* is connected to the Output. If the SEL inputs are:

- more than one = 1 (TRUE)
- none = 1 (TRUE)

the output is set to 0 (FALSE) independently from the *In n* values.

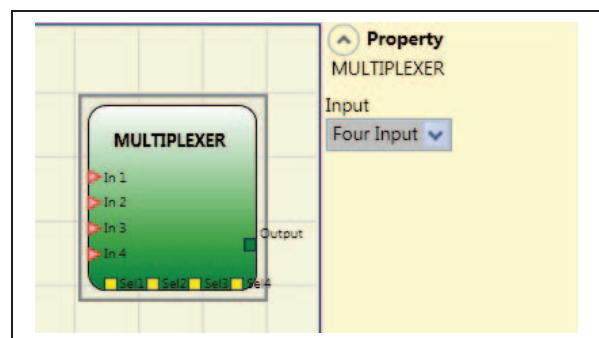

### Parameters

*Number of inputs:* this is used to set between 2 and 4 inputs.

**MEMORY OPERATORS**

MEMORY operators can be used if you decide to save any data (TRUE or FALSE) from other project components.

Status changes are performed according to the truth tables shown for each operator.

**D FLIP FLOP (max number = 16)**

The D FLIP FLOP operator saves the previously set status on output Q according to the following truth table.

Preset	Clear	Ck	D	Q
1	0	X	X	1
0	1	X	X	0
1	1	X	X	0
0	0	L	X	Keep memory
0	0	Rising edge	1	1
0	0	Rising edge	0	0

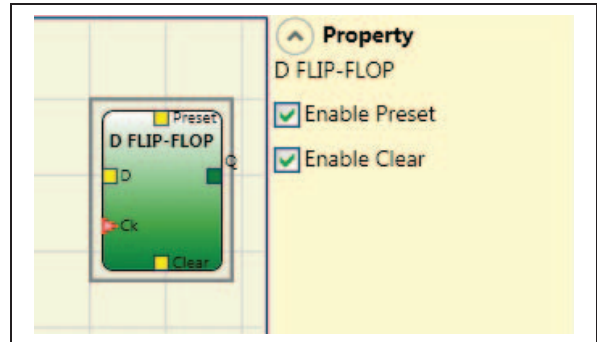

*Parameters*

*Preset:* If selected enables output Q to be set to 1 (TRUE).

*Clear:* If selected enables the saving process to be reset.

## SR FLIP FLOP

SR FLIP FLOP operator brings output Q at 1 with Set, 0 with Reset.  
See the following truth table.

SET	RESET	Q
0	0	Keep memory
0	1	0
1	0	1
1	1	0

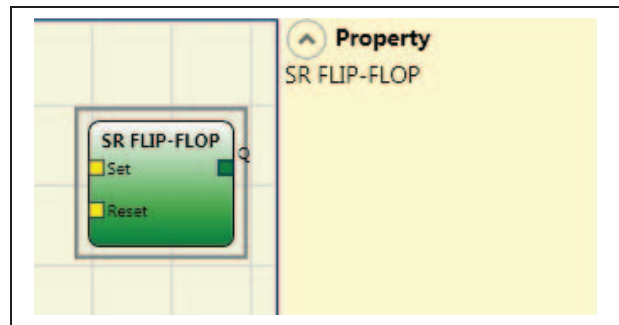

## USER RESTART MANUAL (max number = 16 with RESTART MONITORED)

The USER RESTART MANUAL operator saves the restart signal according to the following truth table.

Clear	Restart	In	Q
1	X	X	0
X	X	0	0
0	L	1	Keep memory
0	Rising edge	1	1
0	Falling edge	1	Keep memory

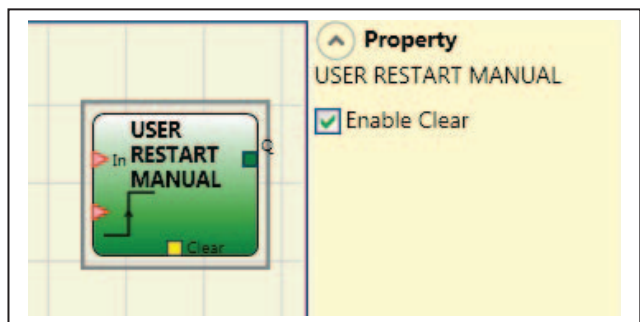

### Parameters

*Clear enable:* If selected enables the saving process to be reset.

## USER RESTART MONITORED (max number = 16 with RESTART MANUAL)

The USER RESTART MONITORED operator is used to save the restart signal according to the following truth table.

Clear	Restart	In	Q
1	X	X	0
X	X	0	0
0	L	1	Keep memory
0	Rising edge	1	Keep memory
0		1	1

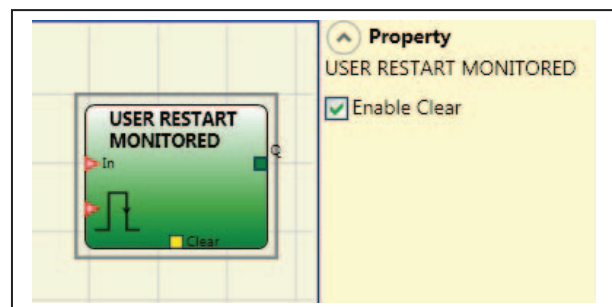

### Parameters

*Clear enable:* If selected enables the saving process to be reset.

## GUARD LOCK OPERATORS

### GUARD LOCK

The **GUARD LOCK** operator controls locking/unlocking of an **ELECTROMECHANICAL GUARD LOCK** by analysing consistency between the Lock command and the status of an E-GATE and a FEEDBACK. The main output is 1 (TRUE) when the guard lock is closed and locked.

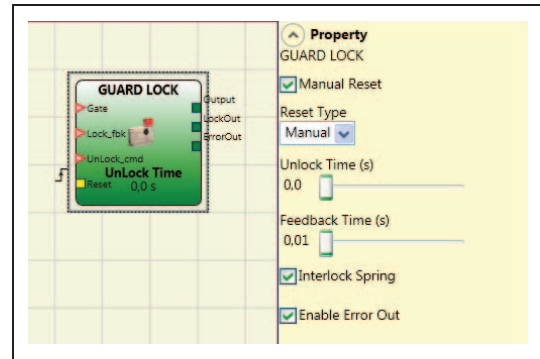

#### Operating principles.

The function acts as a gate safety lock.

- 1) The **GATE** input must always be connected to an **E\_GATE** lock input (guard feedback).
- 2) The **Lock\_fbk** input must always be connected to a **LOCK FEEDBACK** (feedback coil lock) input element.
- 3) The **UnLock\_cmd** input can be connected freely in the diagram and determines the request to unlock (when in LL1 state).
- 4) The **OUTPUT** signal of this element is 1 (TRUE) if the guard is closed and locked. When an unlock command is applied to the **UnLock\_cmd** input, the **OUTPUT** signal is set to "0" and the guard is unlocked (**LockOut** output) after a time **UnLock\_Time** configurable as parameter. This output goes to 0 (FALSE) even when error conditions are present (eg. open door with lock locked, **Feedback Time** that exceeds the maximum allowed, ...).
- 5) **Lockout** signal controls the locking/unlocking of the guard.

#### Parameters

##### **UnLock Time (s):**

The time that must pass between the **UnLock\_cmd** input reaching and the real guard unlock (**Lockout output**).

- 0 ms ÷ 1 s Step 100 ms
- 1.5 s ÷ 10 s Step 0.5 s
- 15 s ÷ 25 s Step 5 s

##### **Feedback Time (s):**

Maximum delay accepted between **LockOut** output and **Lock\_fbk** input (must be the one shown on the lock data sheet with appropriate gap decided by the operator).

- 10 ms ÷ 100 s Step 10 ms
- 150 ms ÷ 1 s Step 50 ms
- 1.5 s ÷ 3 s Step 0.5 s

**Interlock Spring:** The guard is locked passively and released actively, i.e. the mechanical force of the spring keeps it locked. *The guard thus continues to be locked even when the power supply is disconnected.*



**Manual Reset:**

There are two types of reset: Manual and Monitored. When Manual is selected the system only verifies the signal's transition from 0 to 1. If Monitored is selected the double transition from 0 to 1 and then back to 0 is verified

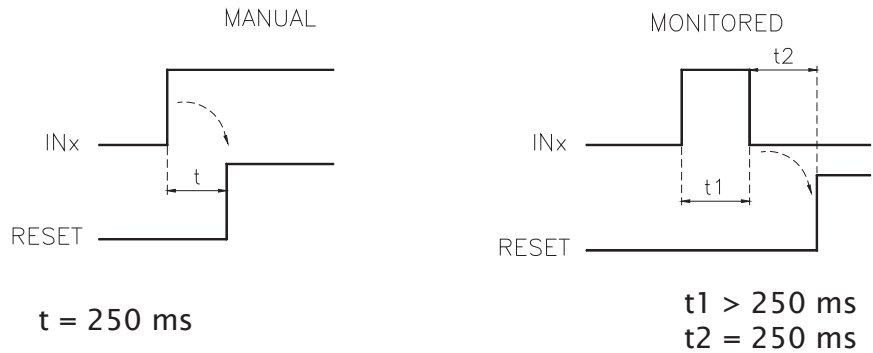

**Important:** for Manual reset always use the input immediately after those used by the function block. E.g.: if inputs 1 and 2 are used for the function block, use input 3 for Reset.

**Enable error out:** This can be selected to enable a signal (Error Out) to indicate a lock malfunction. When Error Out = 1 (TRUE) there is a fault in the lock.

COUNTER OPERATORS

COUNTER operator is a pulse counter that sets output Q to 1 (TRUE) as soon as the desired count is reached.

COUNTER (max number = 16).

The operator COUNTER is a pulse counter. There are 3 operating modes:

- 1) AUTOMATIC
- 2) MANUAL
- 3) AUTOMATIC + MANUAL

- 1) The counter generates a pulse duration equal to the system response time as soon as the set count is reached. If the CLEAR pin is not enabled this is the default mode.
- 2) The counter leads to 1 (TRUE) the output Q as soon as it reaches the set count. The output Q goes to 0 (FALSE) when the signal CLEAR is activated.
- 3) The counter generates a pulse duration equal to the system response time as soon as the set count is reached. If the CLEAR signal is activated, the internal count goes back to 0.

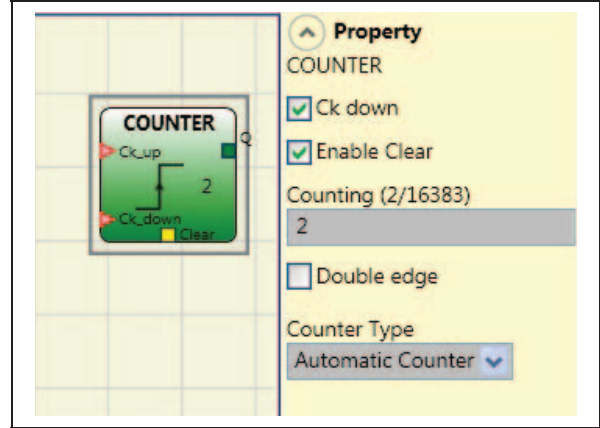

Parameters

*Clear Enable:* If selected this enables the request to clear in order to restart the counter setting output Q to 0 (FALSE). It also offers the possibility of enabling or not enabling (*Automatic Enable*) automatic operation with manual reset.

If this is not selected operation is automatic. Once the set count is reached output Q is set to 1 (TRUE) and stays in this condition for two internal cycles after which it is resetted.

*Ck down:* Enables counting down.

*Two-way:* If selected it enables counting on both the rising and falling edges.

TIMER OPERATORS (max number = 16)

TIMER operators allow you to generate a signal (TRUE or FALSE) for a user-definable period.

CLOCKING

CLOCKING operator generates a clock signal output with the desired period if the input In is 1 (TRUE).

Parameters

*Time:* The period can be set to between 10 ms and 1093.3 s.

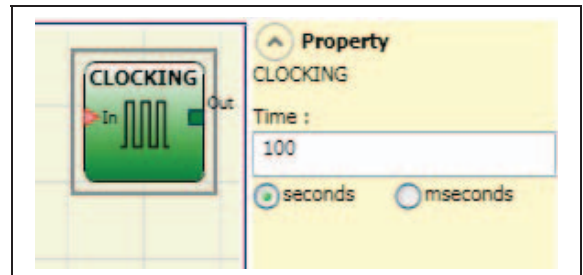

## MONOSTABLE

The MONOSTABLE operator generates a level 1 (TRUE) output activated by the rising edge of the input and remains in this condition for the set time.

### Parameters

**Time:** The delay can be set to between 10 ms and 1093.3 s.

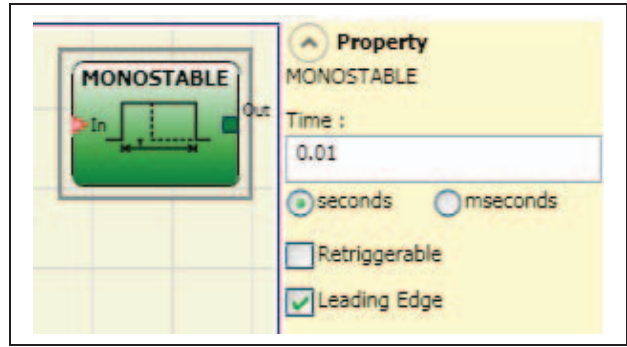

**Rising edge:** If selected, the output is set to 1 (TRUE) on the input signal's rising edge where it remains for the set time, which can be extended for as long as the input stays at 1 (TRUE).

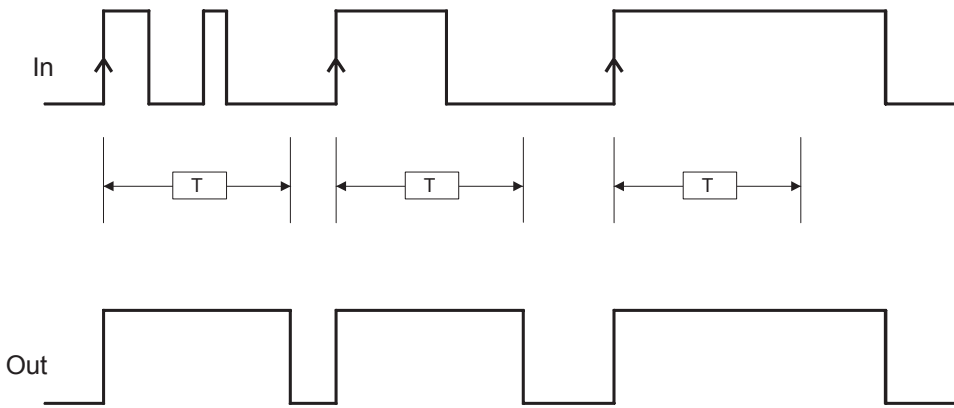

If not selected the logic is inverted, the output is set to 0 (FALSE) on the input signal's falling edge, where it remains for the set time, which can be extended for as long as the input stays at 0 (FALSE).

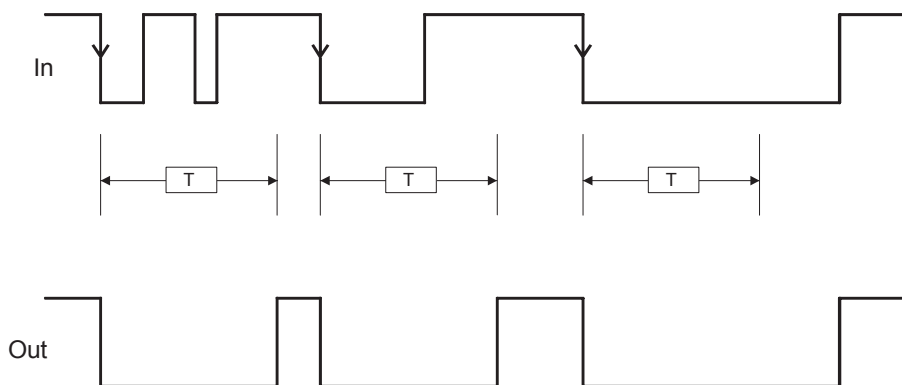

**Retriggerable:** If selected the time is reset each time the input status changes.

PASSING MAKE CONTACT

In the PASSING MAKE CONTACT operator the output follows the signal on the input. However, if this is 1 (TRUE) for longer than the set time, the output changes to 0 (FALSE). When there is an input falling edge, the timer is cleared.

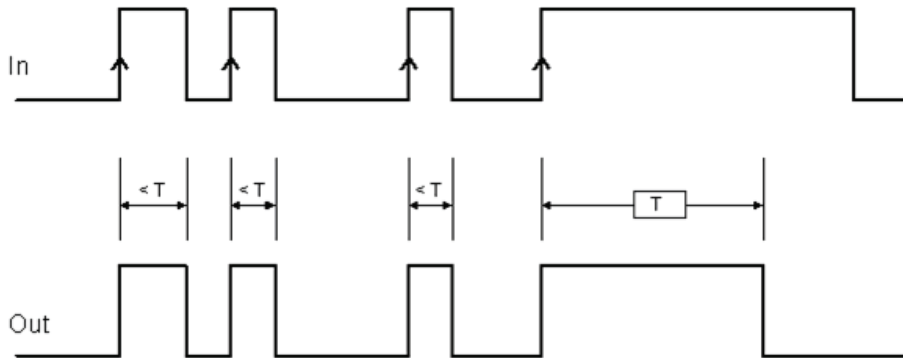
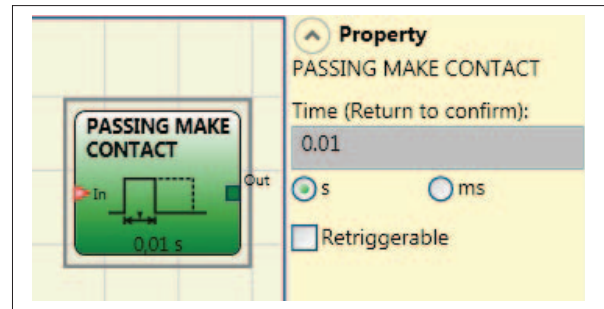

Parameters

**Time:** The delay can be set to between 10 ms and 1093.3 s.

**Retriggerable:** If selected the time is not reset when there is an input falling edge. The output stays 1 (TRUE) for all the selected time. When there is a new input rising edge, the timer restart again.

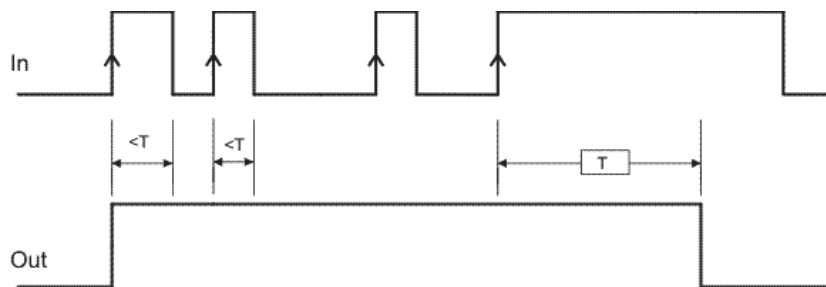

## DELAY

DELAY operator applies a delay to a signal by setting the output to 1 (TRUE) after the set time, against a change in the level of the input signal.

### Parameters

**Time:** The delay can be set to between 10 ms and 1093.3 s.

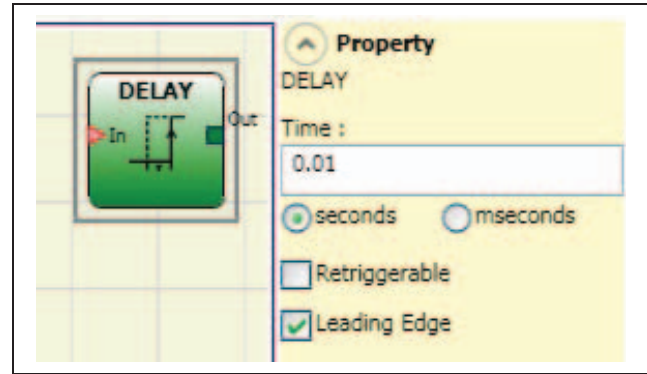

**Rising edge:** If selected, the delay starts on the input signal's rising edge at the end of which the output changes to 1 (TRUE) if the input is 1 (TRUE) where it remains for as long as the input stays at 1 (TRUE).

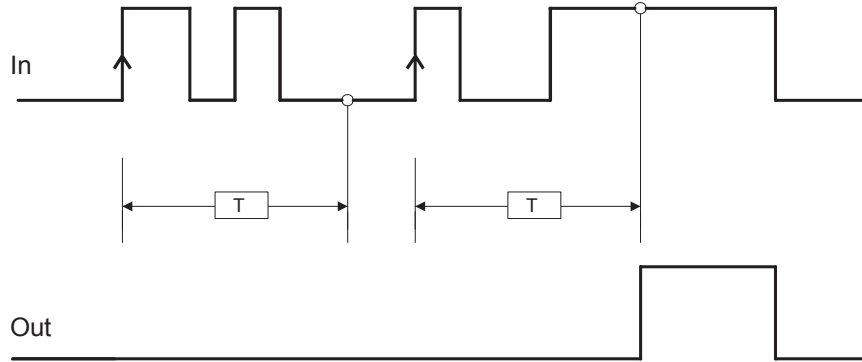

If not selected the logic is inverted, the output is set to 1 (TRUE) on the input signal's falling edge, the delay starts on the input signal's falling edge, at the end of the set time the output changes to 0 (FALSE) if the input is 0 (FALSE) otherwise it remains 1 TRUE.

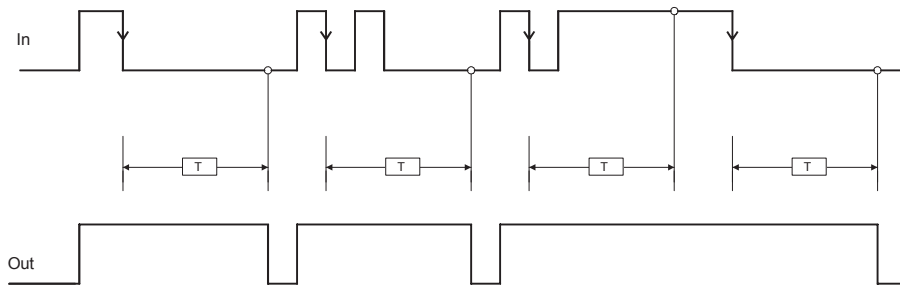

**Retriggerable:** If selected the time is reset each time the input status changes.

MUTING OPERATORS (max number = 4)

"Concurrent" MUTING

The MUTING operator with "Concurrent" logic performs muting of the input signal through sensor inputs S1, S2, S3 and S4.

➔ Preliminary condition: The Muting cycle can only start if all the sensors are 0 (FALSE) and inputs are 1 (TRUE) (barrier free).

Parameters

**Timeout (sec):** Sets the time, between 10 secs and unlimited, within which the Muting cycle must end. If the cycle is not complete at the end of this time, Muting is immediately discontinued.

**Enable:** If selected it enables the possibility of enabling or not enabling the Muting function. Otherwise the Muting function is always enabled.

There are two Enable modes: Enable/Disable and Enable Only. If Enable/Disable is selected the Muting cycle cannot start if Enable is fixed at 1 (TRUE) or 0 (FALSE) but is only activated with a rising edge. To disable muting, set Enable to 0 (FALSE). In this mode the falling edge disables Muting regardless of the condition. If Enable Only is selected Muting cannot be disabled but Enable must be set to 0 (FALSE) in order to enable a new rising edge for the next Muting cycle.

**Direction:** The order in which the sensors are occupied can be set. If set to BIDIR they can be occupied in both directions, from S1&S2 to S3&S4 and from S3&S4 to S1&S2, if set to UP they can be occupied from S1&S2 to S3&S4 and if set to DOWN from S3&S4 to S1&S2.

**Muting Close:** There are two types, CURTAIN and SENSOR. If you select CURTAIN muting closes when the input signal rises, if you select SENSOR it closes when the third sensor has been cleared.

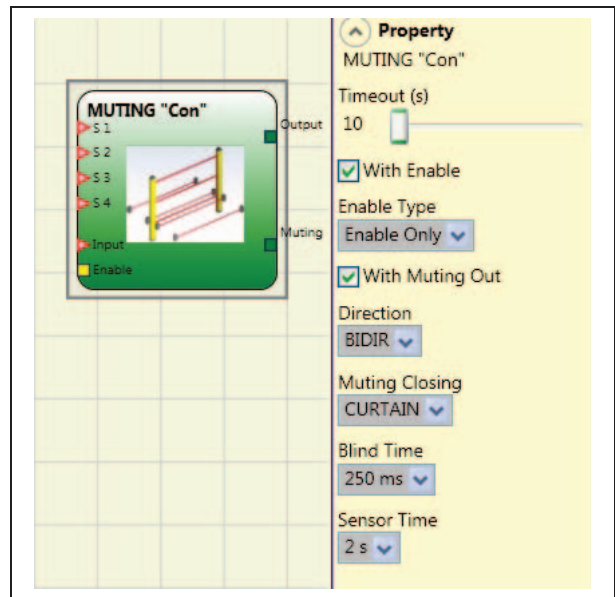

Select CURTAIN

S1	S2	Input	S3	S4	Muting
0	0	1	0	0	0
1	0	1	0	0	0
1	1	1	0	0	1
1	1	X	0	0	1
1	1	X	1	1	1
0	0	0	1	1	1
0	0	1	1	1	0
0	0	1	0	0	0

Select SENSOR

S1	S2	Input	S3	S4	Muting
0	0	1	0	0	0
1	0	1	0	0	0
1	1	1	0	0	1
1	1	X	0	0	1
1	1	X	1	1	1
0	0	0	1	1	1
0	0	1	1	1	1
0	0	1	0	1	0
0	0	1	0	0	0

**Blind Time:** *Only with Muting Close=Curtain*, blind time is enabled if you know that after the complete transition of the pallet (muting cycle close) some protruding objects could still occupy the light curtain and send the input to 0 (FALSE). During blind time the input remains 1 (TRUE). Blind Time can range from 250 msecs to 1 second.

**Sensors Time:** Sets the *maximum time* (between 2 and 5 seconds) between activating two muting sensors.

## MUTING “L”

The MUTING operator with “L” logic performs muting of the input signal through sensor inputs S1 and S2.

➔ Preliminary condition: The Muting cycle can only start if S1 and S2 are 0 (FALSE) and the inputs are 1 (TRUE) (barrier free).

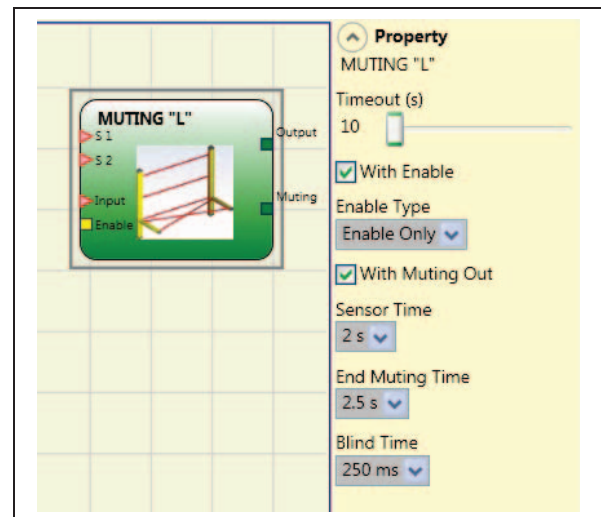

### Parameters

**Timeout (sec):** Sets the time, between 10 secs and unlimited, within which the Muting cycle must end. If the cycle is not complete at the end of this time, Muting is immediately discontinued.

**Enable:** If selected it enables the possibility of enabling or not enabling the Muting function. Otherwise the Muting function is always enabled.

There are two Enable modes: Enable/Disable and Enable Only. If Enable/Disable is selected the Muting cycle cannot start if Enable is fixed at 1 (TRUE) or 0 (FALSE) but is only activated with a rising edge. To disable muting, set Enable to 0 (FALSE). In this mode the falling edge disables Muting regardless of the condition. If Enable Only is selected Muting cannot be disabled but Enable must be set to 0 (FALSE) in order to enable a new rising edge for the next Muting cycle.

**Sensors Time:** Sets the *maximum time* (between 2 and 5 seconds) between activating two muting sensors.

**End of Muting time:** Sets the muting falling time, from 2.5 to 6 seconds, after the first sensor has been cleared.

**Blind Time:** enabled if you know that after the complete transition of the pallet (muting cycle close) some protruding objects could still occupy the light curtain and send the input to 0 (FALSE). During blind time the input remains 1 (TRUE). Blind Time can range from 250 msecs to 1 second.

**"Sequential" MUTING**

The MUTING operator with "Sequential" logic performs muting of the input signal through sensor inputs S1, S2, S3 and S4.

➔ Preliminary condition: The Muting cycle can only start if all the sensors are 0 (FALSE) and the inputs are 1 (TRUE) (barrier free).

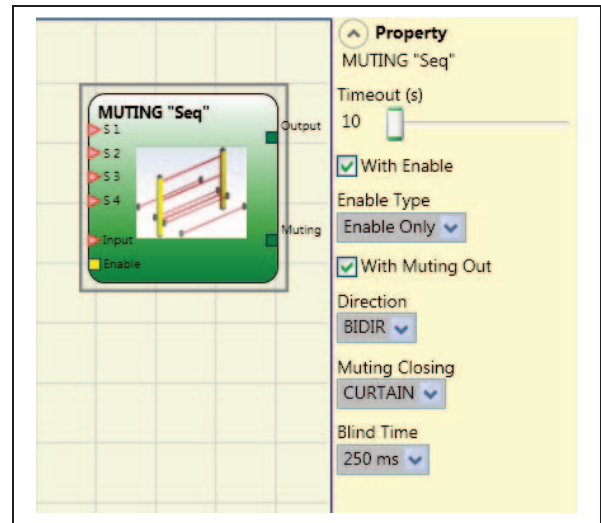

*Parameters*

**Timeout (sec):** Sets the time, between 10 secs and unlimited, within which the Muting cycle must end. If the cycle is not complete at the end of this time, Muting is immediately discontinued.

**Enable:** If selected it enables the possibility of enabling or not enabling the Muting function. Otherwise the Muting function is always enabled.

There are two Enable modes: Enable/Disable and Enable Only. If Enable/Disable is selected the Muting cycle cannot start if Enable is fixed at 1 (TRUE) or 0 (FALSE) but is only activated with a rising edge. To disable muting, set Enable to 0 (FALSE). In this mode the falling edge disables Muting regardless of the condition. If Enable Only is selected Muting cannot be disabled but Enable must be set to 0 (FALSE) in order to enable a new rising edge for the next Muting cycle.

**Direction:** The order in which the sensors are occupied can be set. If set to BIDIR they can be occupied in both directions, from S1 to S4 and from S4 to S1, if set to UP they can be occupied from S1 to S4 and if set to DOWN from S4 to S1.

**Muting Close:** There are two types, CURTAIN and SENSOR. If you select CURTAIN muting closes when the input signal rises, if you select SENSOR it closes when the last sensor has been cleared.

Select CURTAIN

S1	S2	Input	S3	S4	Muting
0	0	1	0	0	0
1	0	1	0	0	0
1	1	1	0	0	1
1	1	X	0	0	1
1	1	X	1	0	1
1	1	X	1	1	1
0	1	X	1	1	1
0	0	0	1	1	1
0	0	1	1	1	0
0	0	1	0	1	0
0	0	1	0	0	0

Select SENSOR

S1	S2	Input	S3	S4	Muting
0	0	1	0	0	0
1	0	1	0	0	0
1	1	1	0	0	1
1	1	X	0	0	1
1	1	X	1	0	1
1	1	X	1	1	1
0	1	X	1	1	1
0	0	0	1	1	1
0	0	1	1	1	1
0	0	1	0	1	0
0	0	1	0	0	0



**Blind Time:** Only with Muting Close=Curtain, blind time is enabled if you know that after the complete transition of the pallet (muting cycle close) some protruding objects could still occupy the light curtain and send the input to 0 (FALSE). During blind time the input remains 1 (TRUE). Blind Time can range from 250 msec to 1 second.

## MUTING "T"

The MUTING operator with "T" logic performs muting of the input signal through sensor inputs S1 and S2.

➔ Preliminary condition: The Muting cycle can only start if S1 and S2 are 0 (FALSE) and the inputs are 1 (TRUE) (barrier free).

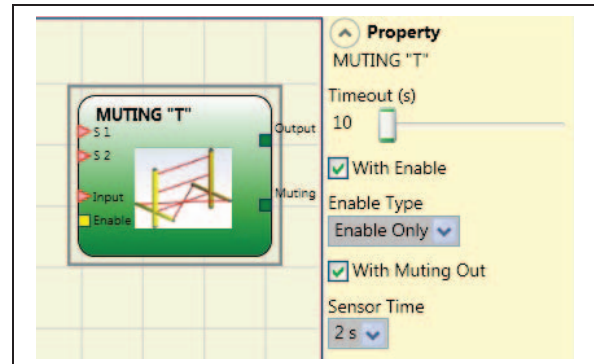

### Parameters

**Timeout (sec):** Sets the time, between 10 secs and unlimited, within which the Muting cycle must end. If the cycle is not complete at the end of this time, Muting is immediately discontinued.

**Enable:** If selected it enables the possibility of enabling or not enabling the Muting function. Otherwise the Muting function is always enabled.

There are two Enable modes: Enable/Disable and Enable Only. If Enable/Disable is selected the Muting cycle cannot start if Enable is fixed at 1 (TRUE) or 0 (FALSE) but is only activated with a rising edge. To disable muting, set Enable to 0 (FALSE). In this mode the falling edge disables Muting regardless of the condition. If Enable Only is selected Muting cannot be disabled but Enable must be set to 0 (FALSE) in order to enable a new rising edge for the next Muting cycle.

**Sensors Time:** Sets the *maximum time* (between 2 and 5 seconds) between activating two muting sensors.

**MUTING OVERRIDE (max number = 16)**

The operator permits override of the directly connected Muting Input.

Override can be activated only if Muting is not active (INPUT=0) and at least one Muting sensor is occupied (or the light curtain is occupied).

Override ends when the light curtain and sensors are cleared and the Output switches to logical "0" (FALSE).

Override can be set to pulsed or maintained action mode.

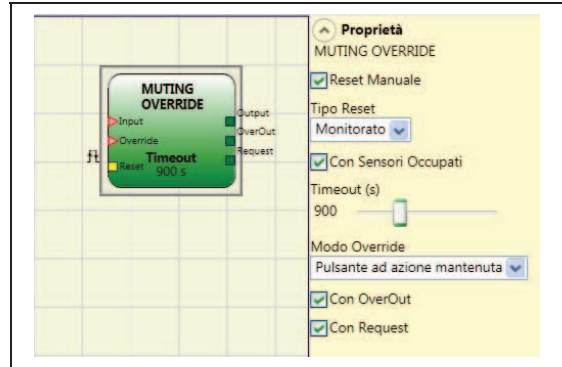

**Override with maintained action control.**

This function must be activated maintaining the Override command active (OVERRIDE=1) during all subsequent operations. However, a new Override can be activated, de-activating and re-activating the command.

When the light curtain and sensors are cleared (gap free) or on expiry of the timeout, Override ends without the need for further commands.

**Override with pulsed action**

This function is enabled activating the Override command (OVERRIDE=1).

Override ends when the light curtain and sensors are cleared (gap free) or on expiry of the timeout. The function can be restarted only if the Override command is re-activated (OVERRIDE=1).

**Parameters**

*With sensors occupied:* Must be selected with "T" sequential, simultaneous muting; with "L" muting, must not be selected.

- ➔ Otherwise, a Warning is displayed in the compilation phase and in the report.
- ➔ The user must adopt additional safety measures during the Override phase.

*Conditions to be checked for activation of Override*

"With sensors occupied " selected	sensor occupied	light curtain occupied	Input	Override request	Override output
X	X	-	0	1	1
-	-	X	0	1	1
	X	-	0	1	1
	X	X	0	1	1

*Timeout (sec):* Used to set the time, between 10 sec and infinity, by which the Override function must end.

*Override mode:* Used to configure the type of Override (pulsed or maintained action).

*With OverOut:* Used to activate an Override active signalling output (active when high).

*With Request:* Used to activate a signalling output (active when high) indicating that the Override function can be activated.

**Manual Reset:**

- Should the INPUT be active (TRUE), the reset enables the output of the function block.
- Should the INPUT be not active (FALSE), the output of the function block follows the OVERRIDE request.

There are two types of reset: Manual and Monitored. When Manual is selected the system only verifies the signal's transition from 0 to 1. If Monitored is selected the double transition from 0 to 1 and then back to 0 is verified.



MISCELLANEOUS FUNCTION BLOCKS

SERIAL OUTPUT

The **Serial Output** operator outputs the status of up to 8 inputs, serialising the information.

**Operating principles.**

This operator outputs the status of all the connected inputs in two different ways:

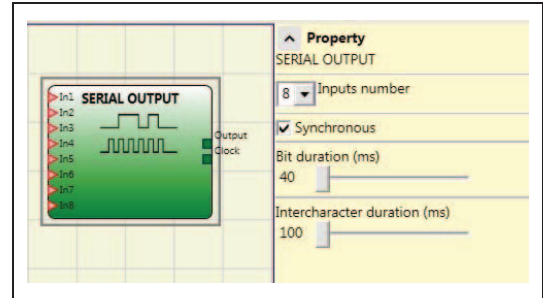

**Asynchronous serialisation:**

- 1) The status of the line in the idle condition is 1 (TRUE);
- 2) The start data transmission signal is 1 bit = (FALSE);
- 3) Transmission of *n* bits with the status of the connected inputs encoded using the *Manchester* method:
  - Status 0: rising edge of the signal at the centre of the bit
  - Status 1: falling edge of the signal at the centre of the bit
- 4) Intercharacter interval is 1 (TRUE) to allow synchronisation of an external device.

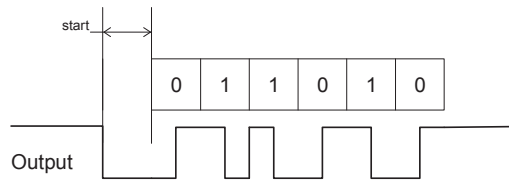

Therefore, with the Asynchronous method the *Clock* output is not present.

**Synchronous serialisation:**

- 1) The output and the clock in the idle condition are 0 (FALSE);
- 2) Transmission of *n* bits with the input status using OUTPUT as data, CLOCK as the timing base;
- 3) Intercharacter interval is 0 (FALSE) to allow synchronisation of an external device.

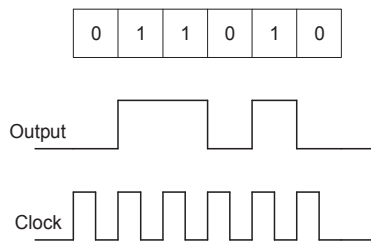

*Parameters*

**Number of inputs:** Defines the number of inputs of the function block, which may be 2÷8 (*asynchronous*) or 3÷8 (*synchronous*).

**Bit length (ms):** Enter the value corresponding to the length of each single bit (input *n*) in the pulse train that makes up the transmission.

- 40 ms ÷ 200 ms (Step 10 ms)
- 250 ms ÷ 0.95 s (Step 50 ms)

**Intercharacter interval (ms):** Enter the time that must pass between the transmission of one pulse train and the next.

- 100 ms ÷ 2.5 s (Step 100 ms)
- 3 s ÷ 6 s (Step 500 ms)

## NETWORK

The **Network** operator is used to distribute Stop and Reset commands via a simple local network. Use **Network\_in** and **Network\_out** to exchange **START**, **STOP** and **RUN** signals between the different nodes.

### Operating principles.

This operator allows stop and reset commands to be distributed simply in a local Mosaic network.

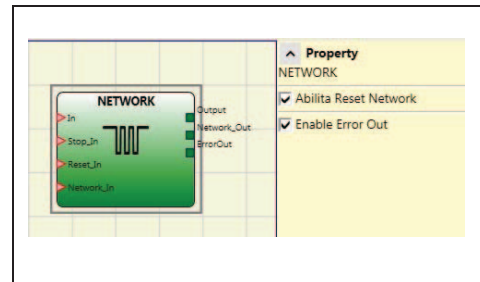

The Network operator requires the following:

- 1) the **Network\_In** input connected to a single or double input must be connected to the **Network\_Out** output of the preceding unit in the local network.
- 2) the **Network\_Out** output connected to a STATUS signal or OSSD output, must be connected to the **Network\_in** input of the next unit in the local network.
- 3) the **Stop\_In** and **Reset\_In** inputs must be connected to input devices that act as Stop (e.g. E-STOP) and Reset (e.g. SWITCH), respectively.
- 4) the **In** input can be connected freely in the diagram (e.g. input function blocks or results of logical combinations).
- 5) **Output** can be connected freely in the diagram. **Output** is 1 (TRUE) when the IN input is 1 (TRUE) and the function block has been restarted.

### Parameters

**Enable Reset Network:** when selected this allows the distribution network to reset the function block. If not enabled, the function block can only be reset via the local **Reset\_In** input.

**Enable error out:** if selected this enables the presence of the **Error\_Out** status signal.

### Example of application:

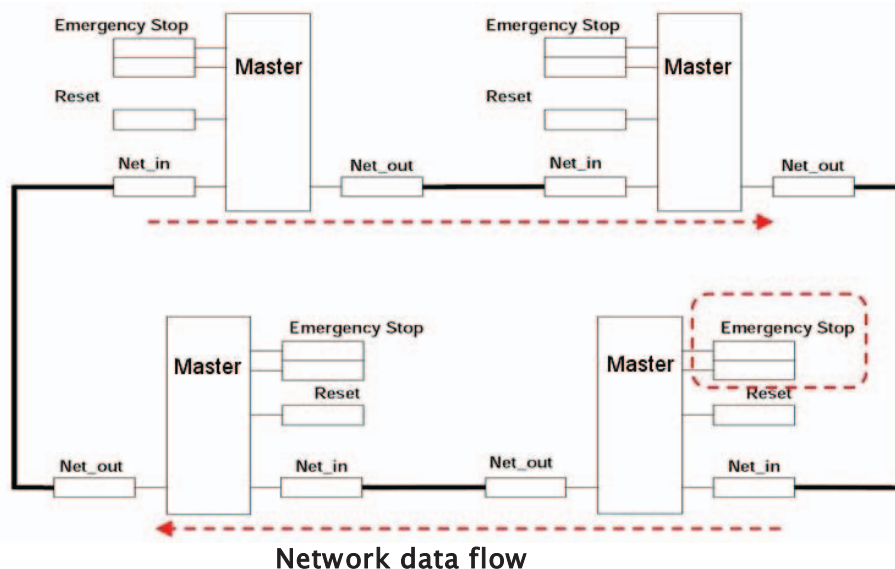

The RESET commands must be installed outside all the danger areas of the network in positions where the danger areas and the entire work areas are clearly visible.

The maximum number of MASTER modules that can be connected in network configuration is equal to 10.

**Condition 1:**

With reference to the figure, at power-on:

1. The OUTPUTs of the various nodes are in the 0 (FALSE) condition;
2. The STOP signal is sent via the **Network\_out** line;
3. When the RESET command is pressed on one of the nodes all the nodes that are present are started when the START signal is sent;
4. As the end result, the OUTPUT of all the connected nodes is in condition 1 (TRUE) if the various IN inputs are in condition 1 (TRUE);
5. The RUN signal is sent via the network of the 4 nodes present.

**Condition 2:**

With reference to the figure, when the emergency stop is pressed in one of the four nodes:

1. The OUTPUT moves to condition 0 (FALSE);
2. The STOP signal is sent via the Network\_out line;
3. The next node receives the stop code and deactivates the output;
4. The stop command generates the stop code for all Network\_in and Network\_out lines;
5. As the end result, the OUTPUT of all the connected nodes is in condition 0 (FALSE).
6. When the emergency stop is restored to the normal position, all the nodes can be restarted by sending the START signal with a single reset. The latter condition does not occur when ENABLE RESET NETWORK is not enabled. In that case, the local reset method must be used.

Response Time

The response time of the network starting from emergency stop is given by the formula:

$$t_{rTot} = (120ms \times n^{o}module) (max 10)$$

example of 4 nodes network:

Emergency Stop Pressure	MASTER	MASTER n°1	MASTER n°2	MASTER n°3
	$t_{rMASTER}$	$120ms \times n^{o}module$	$120ms \times n^{o}module$	$120ms \times n^{o}module$
	12,6ms	120ms	240ms	360ms

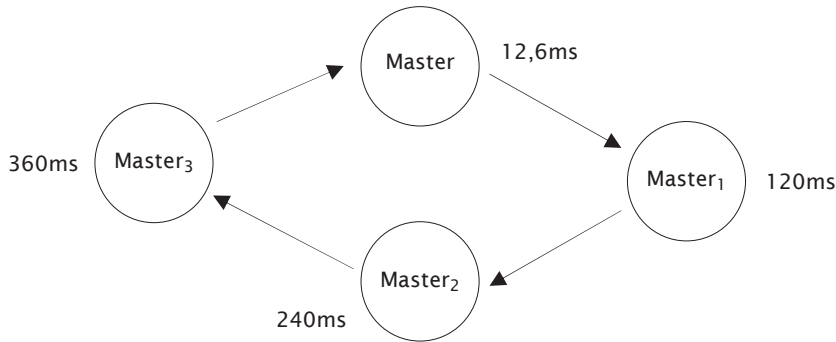

**Condition 3:**

With reference to the figure, when the IN input of the NETWORK function block of one of the 4 nodes moves to condition 0 (FALSE):

1. The local OUTPUT moves to condition 0 (FALSE);
2. The RUN signal continues to be sent via the Network\_out lines;
3. The states of the remaining nodes remain unchanged;
4. In that case, local reset must be used. The Reset-in LED flashes to indicate this condition. All the nodes can be restarted by sending the START signal with a single reset. The latter condition does not occur when ENABLE RESET NETWORK is not enabled. In that case, the local reset method must be used.

The **Reset\_in** and **Network\_in** inputs and the **Network\_out** output can only be mapped to the I/O pins of the MASTER.

Master M1 signals with Network operative

NETWORK FUNCTIONAL BLOCK SIGNALS						
		Network in		Network out (OSSD)	Network out (STATUS)	Reset in
LED		FAIL EXT	IN (1)	OSSD (2)	STATUS	IN (3)
STATUS	STOP	OFF	OFF	RED	OFF	OFF
	CLEAR	OFF	BLINKING	RED/GREEN (BLINKING)	BLINKING	BLINKING
	RUN	OFF	ON	GREEN	ON	ON
	FAIL	ON	BLINKING	-	-	-

(1) Corresponding to the input where is wired Network IN  
 (2) Corresponding to the input where is wired Network OUT  
 (3) Corresponding to the input where is wired Reset IN

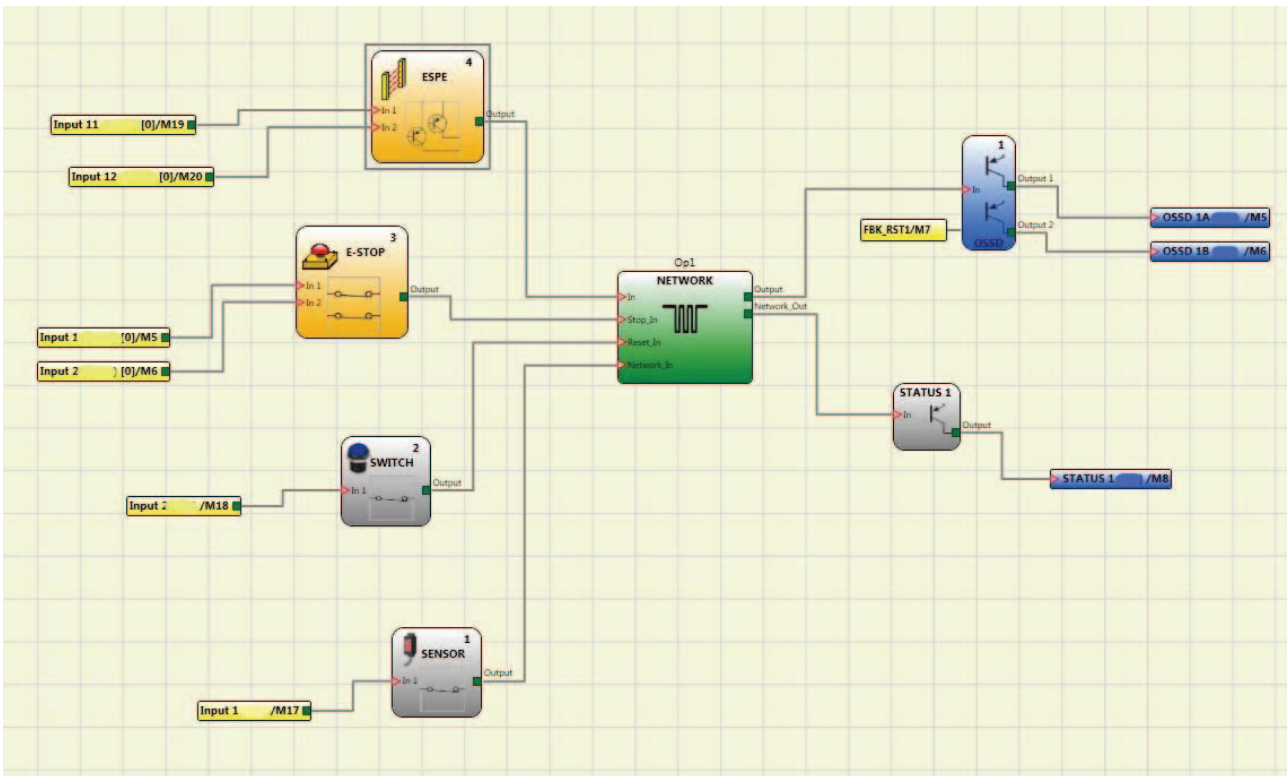

Figure 48 - Example of use of the NETWORK block

SPECIAL APPLICATIONS

Output delay with manual

If you need to have two OSSD output with one of them delayed (in MANUAL mode) use the following scheme:

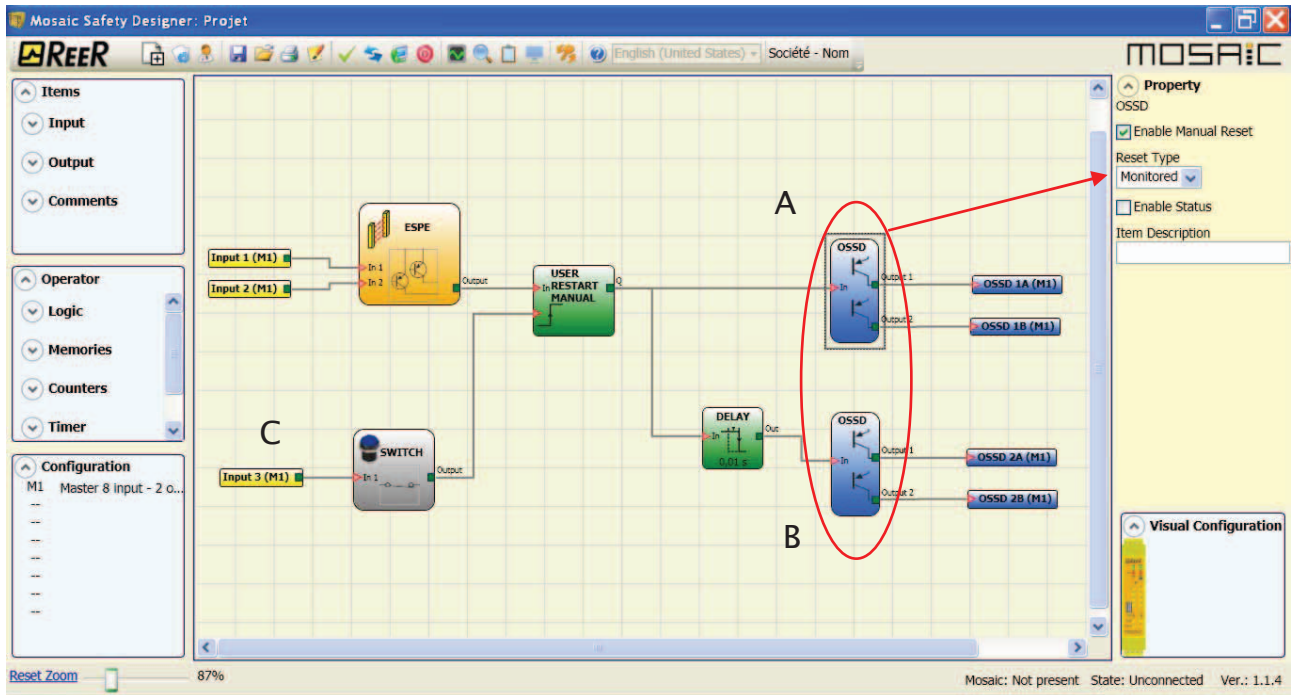

Figure 49 - Two outputs with one delayed (in MANUAL mode)

- ➔ Whereas the operating mode of the logical DELAY (see DELAY paragraph) the application must be the following:
  - The two outputs have to be programmed with RESET TYPE manual (monitored) using the function USER MANUAL RESTART.
- ➔ You must **physically** connect the button RESTART to the inputs RESTART\_FBK1/2 of the OSSD A and B used (see section connections (p. 12)) and to the INPUT3 (C).



**MOSAIC FAIL CODES**

In case of malfunction the Mosaic system transmits to the MSD software a code corresponding to the error detected by the master M1.

To read the code, proceed as follows:

- connect the Master M1 (indicating FAIL by led) to the PC using the USB cable;
- launch the software MSD, a window appears with the error code occurred.

The following table lists all possible errors detected and their solution.

CODE	FAIL	RESOLUTION
19D	<i>The two M1 microcontrollers do not see the same hw/sw configuration</i>	CHECK CORRECT INSERTION OF M1 AND EXPANSION MODULES CONNECTORS MSC. POSSIBLY REPLACE THE CONNECTORS
66D	<i>2 or more same expansion modules with the same node number</i>	CHECK THE CONNECTIONS PIN 2, 3 EXPANSION MODULES
68D	<i>Exceeded max expansion modules number</i>	DISCONNECT THE MODULES IN EXCESS (MAX14)
70D	<i>One or more modules have detected a change in the node number</i>	CHECK THE CONNECTIONS OF PIN 2, 3 EXPANSION MODULES
73D	<i>A slave module has detected an external error</i>	CHECK THE ERROR CODE ON MODULE FOR MORE INFORMATION
96D ÷ 101D	<i>Errors related to memory MCM</i>	REPLACE MCM MEMORY
137D	<i>from a MOR4 MOR4S8 - EDM error on the couple RELAY1 and 2 used in Category 4</i>	CHECK THE CONNECTION OF THE EXTERNAL FEEDBACK CONTACTORS
147D	<i>from MOR4 MOR4S8 - EDM error on the Relay 2 and 3 used in Category 4</i>	CHECK THE CONNECTION OF THE EXTERNAL FEEDBACK CONTACTORS
157D	<i>from a form or MOR4 MOR4S8 - EDM error on the Relay 3 and 4 used in Category 4</i>	CHECK THE CONNECTION OF THE EXTERNAL FEEDBACK CONTACTORS
131D	<i>from a MV2, MV1 or MVO - detected disconnection Proxi 1 or 2</i>	CHECK THE PROXI CONNECTIONS. VERIFY THAT THE PROXI CONSUMPTION IS HIGHER THAN OR EQUAL TO 2mA. IF IT IS DIFFERENT, CONNECT A 12KΩ LOAD RESISTANCE BETWEEN PIN 5-6 AND PIN 9-10
132D	<i>from a MV2 - detected disconnection Encoder 1 and 2</i>	CHECK THE ENCODER1,2 CONNECTIONS. IN THE CASE OF ENCODER TTL VERIFY THAT THE EXTERNAL POWER SUPPLIED TO THE MODULE IS ≥ 4,9VDC
136D (Proxi1) 146D (Proxi2)	<i>From a module MV2, MV1 or MVO: over-frequency detected on Proximity input</i>	THE INPUT FREQUENCY MUST BE ≤ 5KHz
139D (Encoder1) 149D (Encoder2)	<i>From a module MV2, MV1 or MVO: encoder input signals not Standard (duty cycle, phase displacement)</i>	THE DUTY CYCLE MUST BE: 50%±33% OF THE PERIOD (HTL, TTL). THE PHASE DISPLACEMENT MUST BE: 90°±33% (HTL, TTL) (not applicable to SIN / COS)
140D (Encoder1) 150D (Encoder2)	<i>From a module MV2, MV1 or MVO: over-frequency detected on Encoder input</i>	THE INPUT FREQUENCY MUST BE: ≤ 500KHz (TTL, SIN/COS); ≤ 300KHz (HTL).
142D	<i>from a MV1 or MV2 - detected disconnection Encoder 1</i>	CHECK THE ENCODER1 CONNECTIONS. IN THE CASE OF ENCODER TTL VERIFY THAT THE EXTERNAL POWER SUPPLIED TO THE MODULE IS ≥ 4,9VDC
144D	<i>from a MV2, MV1 or MVO - detected disconnection Proxi 1</i>	CHECK THE PROXI CONNECTIONS. VERIFY THAT THE PROXI CONSUMPTION IS HIGHER THAN OR EQUAL TO 2mA. IF IT IS DIFFERENT, CONNECT A 12KΩ LOAD RESISTANCE BETWEEN PIN 5-6
152D	<i>from a MV2 - detected disconnection Encoder 2</i>	CHECK THE ENCODER2 CONNECTIONS. IN THE CASE OF ENCODER TTL VERIFY THAT THE EXTERNAL POWER SUPPLIED TO THE MODULE IS ≥ 4,9VDC
154D	<i>from a MV2, MV1 or MVO detected disconnection Proxi 2</i>	CHECK THE PROXI CONNECTIONS. VERIFY THAT THE PROXI CONSUMPTION IS HIGHER THAN OR EQUAL TO 2mA. IF IT IS DIFFERENT, CONNECT A 12KΩ LOAD RESISTANCE BETWEEN PIN 9-10
194D 197D 198D 199D 201D 202D 203D 205D	<i>Errors solid state output OSSD1</i>	CHECK THE OSSD1 CONNECTIONS RELATIVE TO THE MODULE IN ERROR
208D 211D 212D 213D 215D 216D 217D 219D	<i>Errors solid state output OSSD2</i>	CHECK THE OSSD2 CONNECTIONS RELATIVE TO THE MODULE IN ERROR
222D 225D 226D 227D 229D 230D 232D 233D	<i>Errors solid state output OSSD3</i>	CHECK THE OSSD3 CONNECTIONS RELATIVE TO THE MODULE IN ERROR
236D 239D 240D 241D 243D 244D 245D 247D	<i>Errors solid state output OSSD3</i>	CHECK THE OSSD3 CONNECTIONS RELATIVE TO THE MODULE IN ERROR

**All other codes are related to errors or an internal malfunction. Please replace the module that gave the error or return to Reer for repair and / or debugging.**

## ACCESSORIES AND SPARE PARTS

MODEL	DESCRIPTION	CODE
M1	MOSAIC main unit (8 inputs / 2 double OSSD )	1100000
M18O2	MOSAIC I/O expansion unit (8 inputs / 2 double OSSD)	1100010
M18	MOSAIC input expansion unit (8 inputs)	1100020
M116	MOSAIC input expansion unit (16 inputs)	1100021
M112T8	MOSAIC input expansion unit (12 input, 8 test output)	1100022
MO2	MOSAIC output expansion unit (2 double OSSD)	1100030
MO4	MOSAIC output expansion unit (4 double OSSD)	1100031
MR2	MOSAIC safety relay unit (2 relays)	1100040
MR4	MOSAIC safety relay unit (4 relays)	1100041
MOR4	MOSAIC safety relay expansion unit (4 relays)	1100042
MOR4S8	MOSAIC safety relay expansion unit (4 relays, 8 test outputs)	1100043
MBP	MOSAIC PROFIBUS DP interface unit	1100050
MBD	MOSAIC DeviceNet interface unit	1100051
MBC	MOSAIC CANopen interface unit	1100052
MBEC	MOSAIC ETHERCAT interface unit	1100053
MBEI	MOSAIC ETHERNET/IP interface unit	1100054
MBEP	MOSAIC PROFINET interface unit	1100055
MCT2	MOSAIC BUS TRANSFER interface unit (2 channels)	1100058
MCT1	MOSAIC BUS TRANSFER interface unit (1 channel)	1100057
MCM	MOSAIC external configuration memory	1100060
MSC	MOSAIC connector for 5-way communication	1100061
CSU	MOSAIC USB cable for connection to PC	1100062
MV1T	MOSAIC TTL expansion unit	1100070
MV1H	MOSAIC HTL expansion unit	1100071
MV1S	MOSAIC SIN/COS expansion unit	1100072
MV2T	MOSAIC TTL expansion unit (2 encoders)	1100073
MV2H	MOSAIC HTL expansion unit (2 encoders)	1100074
MV2S	MOSAIC SIN/COS expansion Unit (2 encoders)	1100076
MV0	MOSAIC proximity expansion unit	1100077

## WARRANTY

ReeR warrants that all of its MOSAIC units shall be free from defects in material or workmanship for a period of 12 (twelve) months from the date of shipment. This warranty applies to the products under normal conditions of use.

If the product proves to be defective during the warranty period, ReeR will repair or replace any faulty parts without any charge for material or labour.

ReeR S.p.A. may, at its discretion, replace the defective equipment with the same type of equipment or with equipment having the same characteristics, rather than repair it.

This warranty is subject to the conditions listed below:

The customer must inform ReeR of the fault within twelve months from the date of delivery of the product.

The equipment and all components must be in the condition as they were at the time of delivery by ReeR.

The fault or defect must not be caused either directly or indirectly by:

- Improper use;
- Failure to comply with the instructions for use;
- Carelessness, misuse, incorrect maintenance;
- Repairs, modifications, adaptations not performed by ReeR, tampering, etc.;
- Accidents or collisions (also during transportation and as a result of force majeure);
- Other causes for which ReeR cannot be held liable.

The defective equipment must be delivered or shipped to ReeR's works to be repaired: the warranty does not cover costs of transport or the risk of damage to or loss of the equipment during shipment, which shall be borne by the customer.

All products and components that are replaced become the property of ReeR.

ReeR shall not be held liable under any other warranties or rights except for those expressly indicated above. ReeR shall not therefore accept claims to pay damages for expenses, interruption of work or other factors or circumstances in any way related to failure of the product or any parts thereof.

*Please, visit the website [www.reer.it](http://www.reer.it) for the list of the authorised representative of each Country.*



Precise, complete compliance with all standards, instructions and warnings in this handbook is essential for the correct operation of the device. ReeR therefore declines any responsibility for all and anything resulting from failure to comply with all or some of the aforesaid instructions.

*Characteristics are subject to change without prior notice. No part of this document may be reproduced unless authorised by ReeR.*



ReeR S.p.A.  
32 via Carcano  
10153 Torino Italia  
Tel. +39/0112482215 r.a.  
Fax +39/011859867  
Internet: [www.reer.it](http://www.reer.it)  
e-mail: [info@reer.it](mailto:info@reer.it)