

LFX-50RD/SW/GR/BL

Model	LFX-50RD	LFX-50SW/GR/BL
Voltage	24V DC	24V DC
Power consumption	2.4W	3.3W
Mass	180g	
Connector type	3P (1: +, 2: NC, 3: -)	

Third Angle Projection Units: mm

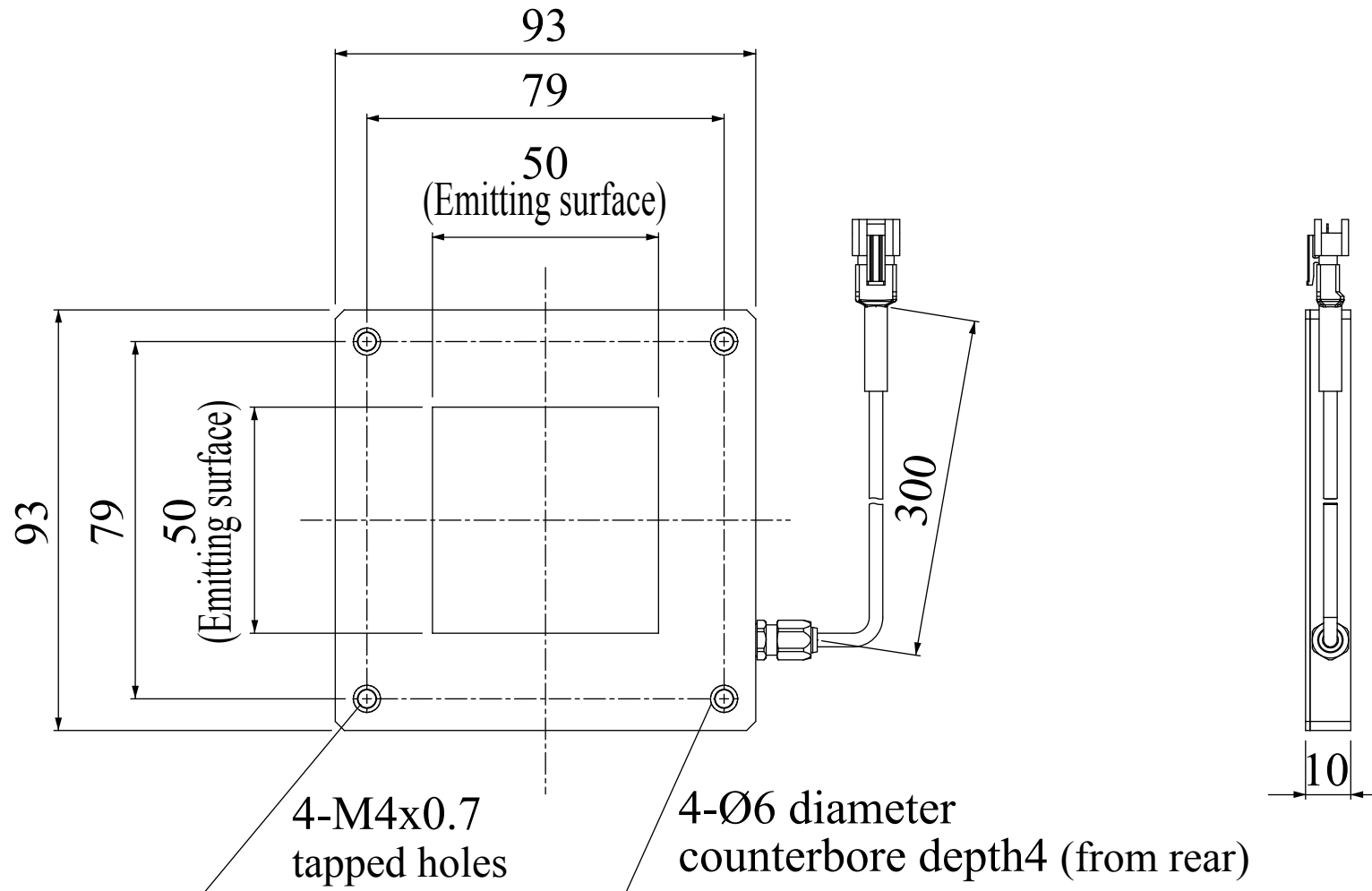



Flat-Dome Lights

LFX Series

Unique lighting technology allows either coaxial lighting or a dome effect depending on the working distance

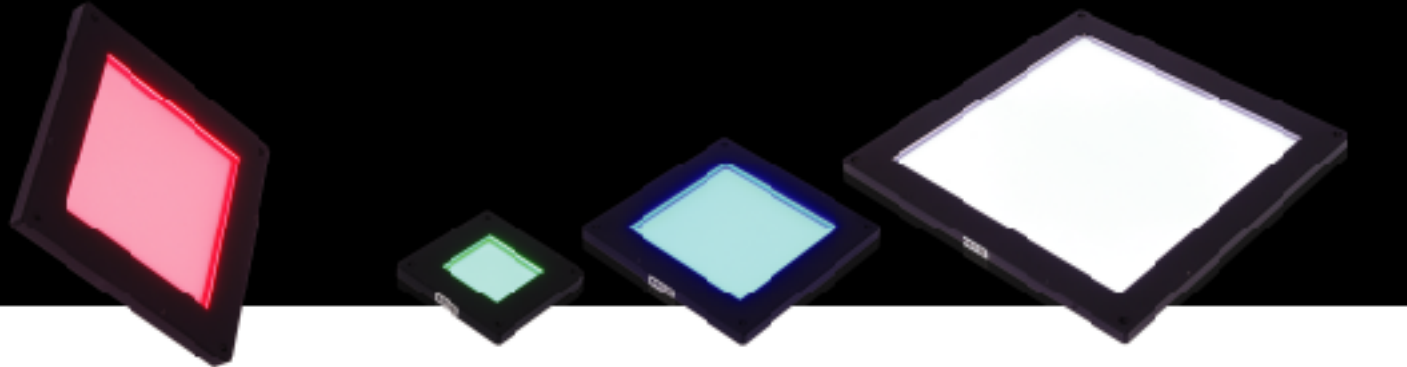

Unique lighting technology achieves uniform omni directional diffused light.

The special pattern of dots reproduces the characteristics of a coaxial light or a dome light.

LFX-100RD

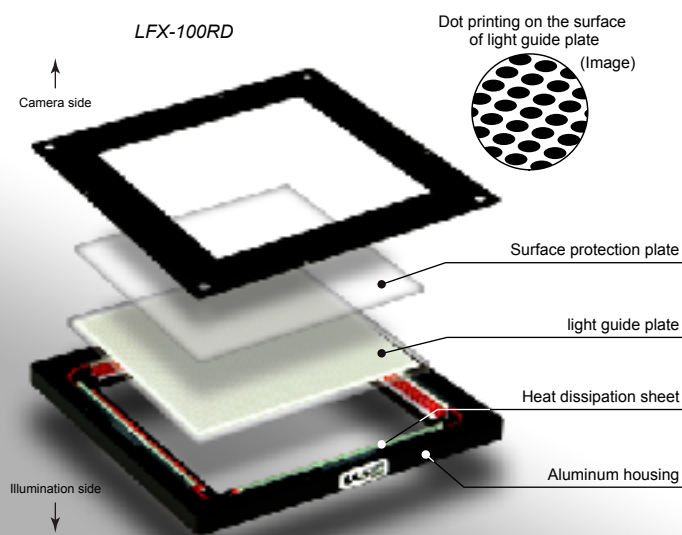

* Under certain conditions dots may be focused by lens or produce an interference pattern with reflections from some highly reflective surfaces. These effects are not defects and testing should be done to ensure this light is appropriate for your application.

The LFX Series is a completely new type of light product enabled by CCS's cutting research and development capabilities. The pattern of dots on the surface of the light guiding diffuser plate controls light diffusion and transmission making uniform, omni-directional light possible.

Lightweight, thin design enables installation in constrained spaces.

The LFX-100 requires 96-mm less installation height than the comparable standard LFXV2-100 coaxial light with the same light-emitting surface.

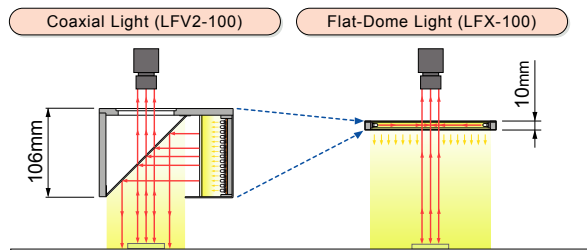

The LFX 100 requires 60-mm less installation height than the comparable standard LDM2-90 dome light with the same field of view.

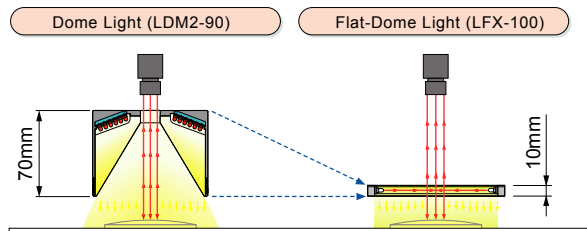

Compared to coaxial lights and dome lights, the flat-dome lights have achieved lightweight and compact design. The flat-dome lights are designed to require thickness of only 10 mm.

Product Lineup Table

Series	Model Name	Color	Power Consumption	Options	Dimension
LFX	LFX-50RD	●	24V/2.4W	—	1 □
	LFX-50SW/GR/BL	○/●/●	24V/3.3W	—	
	LFX-100RD	●	24V/4.8W	—	2
	LFX-100SW/GR/BL	○/●/●	24V/6.5W	—	
	LFX-200RD	●	24V/9.6W	—	3
	LFX-200SW/GR/BL	○/●/●	24V/13W	—	

Dimensions (Unit: mm)

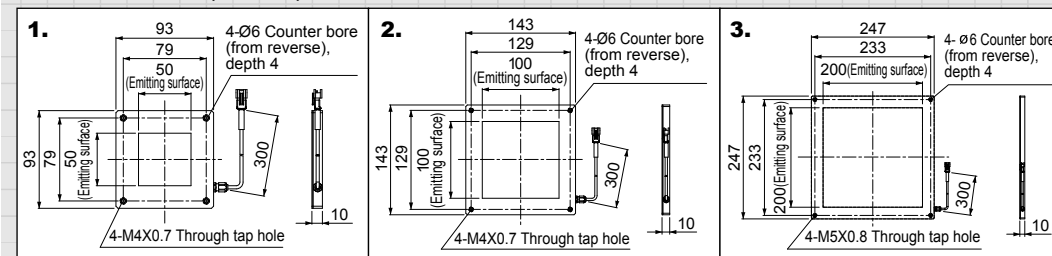

LFX-100 Construction

LEDs mounted in the rim emit light through the light guiding diffuser plate and exit the surface as uniform omni directional diffused light.

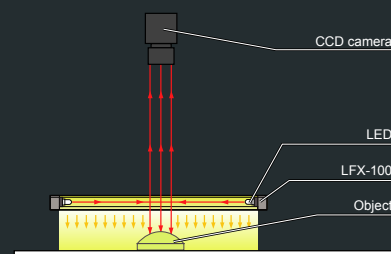

Application Examples using LFX series lights

Printed characters on food packaging film
Ambient light image



When the light is too small or is too far away it behaves like a coaxial light, creating a uniform reflection only where the surface has sufficiently low curvature.

Light used: LFX-50RD

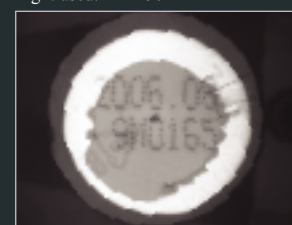

When an LFX flat dome is used very close to the part and is sufficiently large it eliminates shadows and uniformly illuminates the surface even on curved highly reflective objects.

Light used: LFX-100RD



Application Examples using LFX series lights

Cans lid print and features
Ambient light image

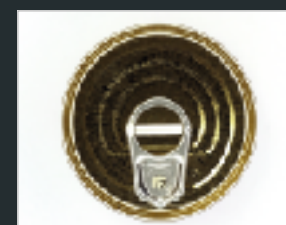

With the LFX at distance of 10 mm from the light to the object the shadows from the non planar features on the lid a minimized and all but disappear.

Light used: LFX-100RD



With the LFX at distance of 85 mm from the light to the object, the light is able to highlight the significantly raised pull-tab.

Light used: LFX-100RD

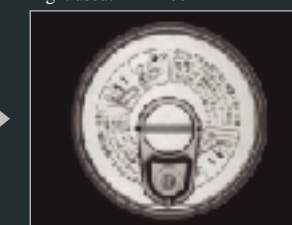

With the LFX at distance of 295 mm from the light to the object, the more collimated light shows the smaller ridges in the can surface clearly.

Light used: LFX-100RD

