

**COGNEX®**

---

# DataMan™ 200

Quick Reference Guide

**DATAMAN**  
ID Readers

**1****Getting Started**

DataMan 200 Systems • DataMan 200 Image Formation Options • DataMan 200 Accessories

**Page 4****2****Setting Up Your DataMan**

Reader Layout • Setting the Focus Position • Mounting the Reader • Connecting the Reader • Reading Distances • Install DataMan 200 Software • Troubleshooting an Ethernet Connection

**Page 6****3****DataMan Software**

Start the Setup Tool • Use the Setup Tool General Toolbar • DataMan 200 Triggering • Trigger Modes • Training the Reader

**Page 14****4****Connections**

C-Mount Option • Installing a C-Mount Lens • Liquid Lens • EtherNet/IP Support • I/O Cable • Acquisition Triggering • High-Speed Output Lines • High-Speed Output Wiring • RS-232 Cable • DataMan 200 Specifications • Multi-Port Connections

**Page 22****5****Compliance Information, Warnings and Notices**

Compliance Notice • Warnings and Notices

**Page 34**

## DataMan 200 Systems

	High-Speed Part Moving Applications	1DMax™ — Best-In-Class 1D Reading	IDQuick™ — High-Speed 2D Reading	IDMax™ — Difficult DPM Reading
DataMan 200S* (DMR-200S-xx)		✓	✓	
DataMan 200QL** (DMR-200QL-xx)	✓	✓		
DataMan 200Q (DMR-200Q-xx)	✓	✓	✓	
DataMan 200X (DMR-200X-xx)	✓	✓	✓	✓













\*S: Maximum decode rate of 5 codes / sec

\*\*QL: 1D / Stacked symbols only

## DataMan 200 Image Formation Options

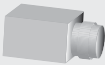
	Description	Build Option	Field Upgradeable
Manual Focus Option (DMR-200x-00)	User-settable focus positions from 40 to 105mm.	✓	N/A
Liquid Lens Option (DMR-200x-01)	Software-controlled adaptive autofocus.	✓	Yes
C-Mount Option (DMR-200x-02)	Allows use of customer-supplied C-mount lenses.	✓	No

## DataMan 200 Accessories

	CD-ROM (Setup Tool and Drivers) (206-6400-330)		Liquid Lens Module (DM200-LLM-000)
	Quick Reference Guide (590-7111)		Ethernet M12 to RJ45 cable (CCB-84901-1003-xx)
	Mounting bracket (DM100-UBRK-000)		I/O cable (CCB-M8IO-xx)
	Pivot Mounting Bracket (DM100-PIVOTM-00)		RS-232 cables (CCB-M8X4-xx)
	AC Power over Ethernet (PoE) Injector (CPS-AC-POE1A-xx)		24V Power over Ethernet (PoE) DIN-RAIL Mount Adapter (CPS-24V-POE1)
	Harsh Environment Enclosure (DM100-HENCL-00)		Direct part mark illumination kit (DM100-DPML-000)
	Red lens cover (ESD-safe) (DM100-RLC-000)		Clear lens cover (ESD-safe) (DM100-CLC-000)

## Reader Layout

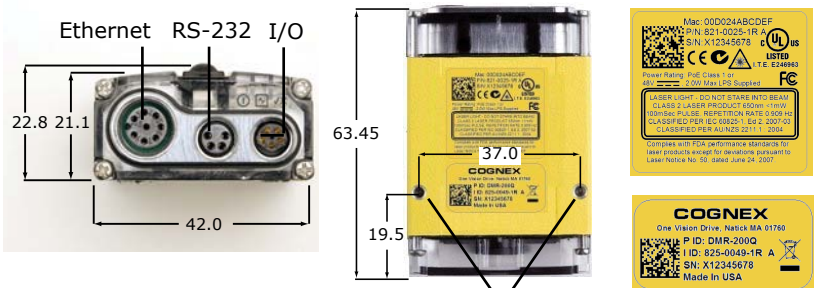

Mounting holes  
(M3 X 5)

- System
- Yellow: Power
  - Green: Ethernet connected
  - Blink: Communication (RS232, Ethernet or both)

- User
- Yellow: Untrained
  - Green: Trained
  - Blinking: Trigger

- Status
- Green (pulse): Read
  - Red (pulse): No read
  - Red/Green (long pulse): Train or Optimize Focus result

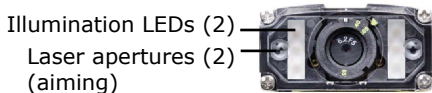

## Setting the Focus Position

DataMan can operate in one of three distance ranges. To set the focus position:

1. Remove screws and lens cover.

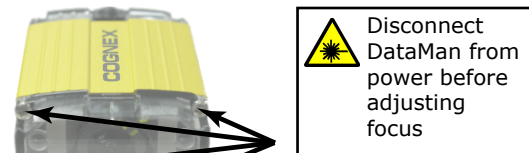

2. Set focus position.

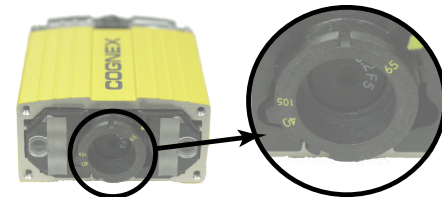

3. Replace lens cover and screws.

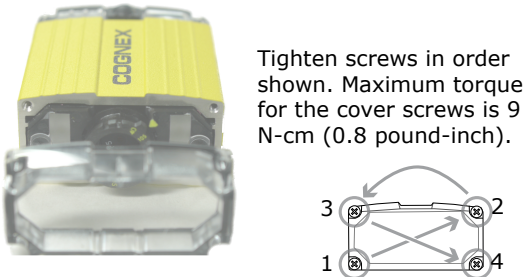

## Mounting the Reader

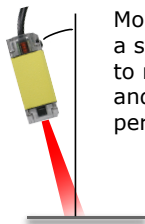
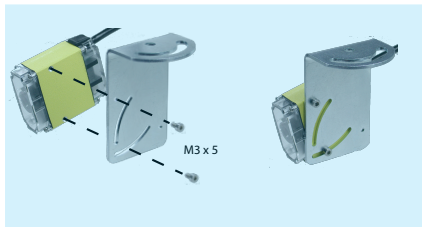

Mount the reader at a slight angle (15°) to reduce reflections and improve reader performance.

Horizontal field of view for the DataMan 200 at working distances of 40mm, 65mm and 105mm (with and without optional liquid lens):

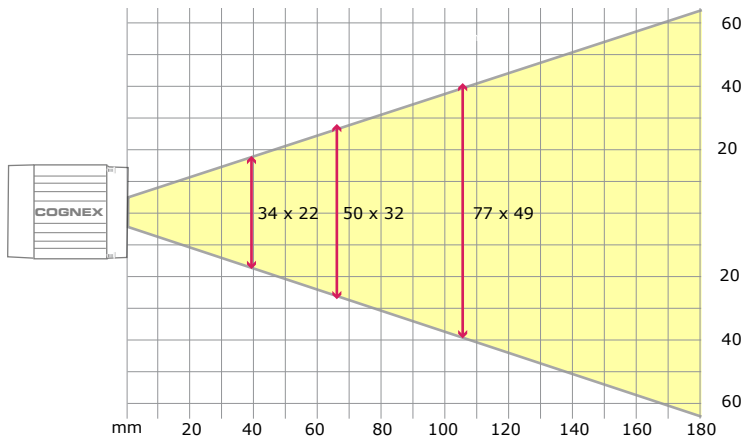

## Connecting the Reader

Supply power to the reader using a Power over Ethernet (PoE) injector. Cognex recommends the following connection sequence:

1. Connect the PoE injector with the Ethernet installation (both sides of the patch cable).
2. Connect the power cord (AC 230V/110V) to the PoE injector.
3. Connect the reader to the PoE injector.

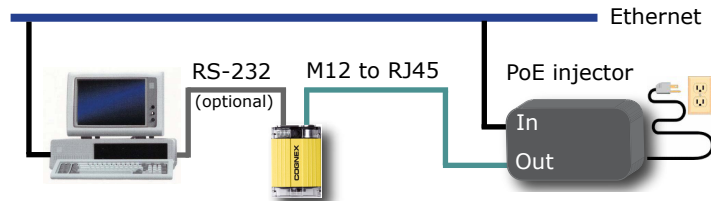

To disconnect the reader:

1. Disconnect the reader from the PoE injector.
2. Disconnect the power cord from the PoE injector.
3. Disconnect the PoE injector from the Ethernet installation.

Using an RS-232 connection can be necessary to configure the reader with parameters that allow it to communicate over your Ethernet network.



Disconnect DataMan from power before removing or changing cables.

# Reading Distances

Supported range of reading distances for four code sizes (6, 8, 10, and 12 mil) at each of the three focus positions (40mm, 65mm, and 105mm).

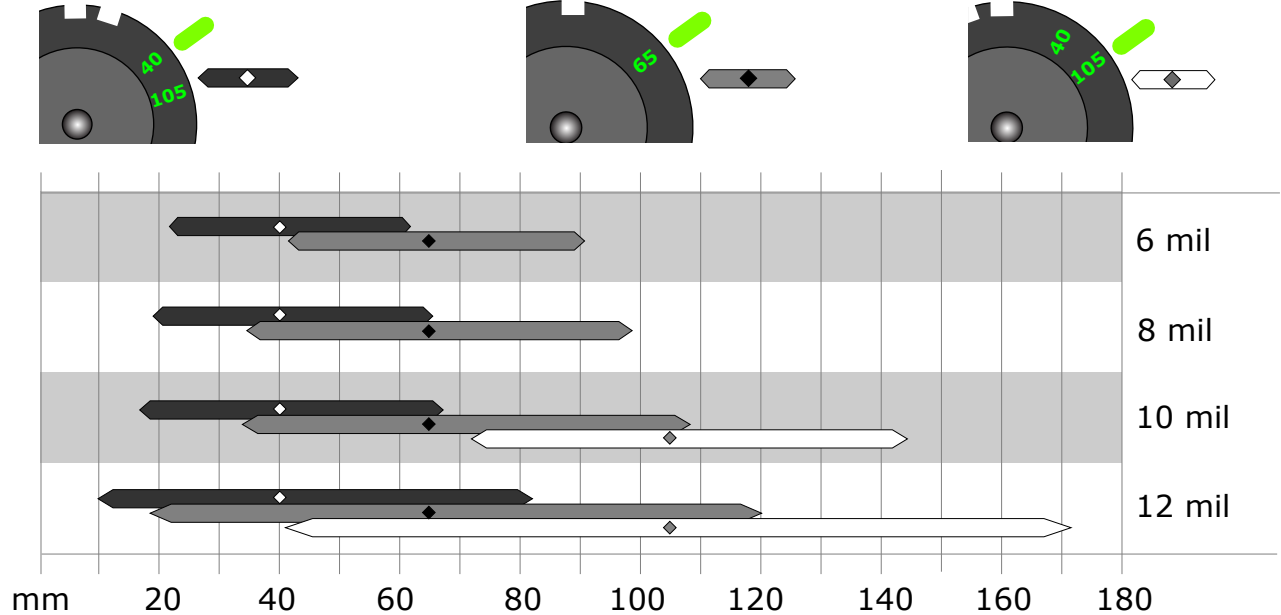

## Install DataMan 200 Software

1. Check the DataMan Release Notes for a full list of system requirements.
2. Insert CD-ROM and follow the on-screen prompts.
3. Connect the DataMan 200 to your PC.
4. Launch the Setup Tool and click **Refresh**.

The reader will appear under **COM ports**, **Network devices**, or both.

5. Select a **COM port** listing or **Network devices** listing and click **Connect**.

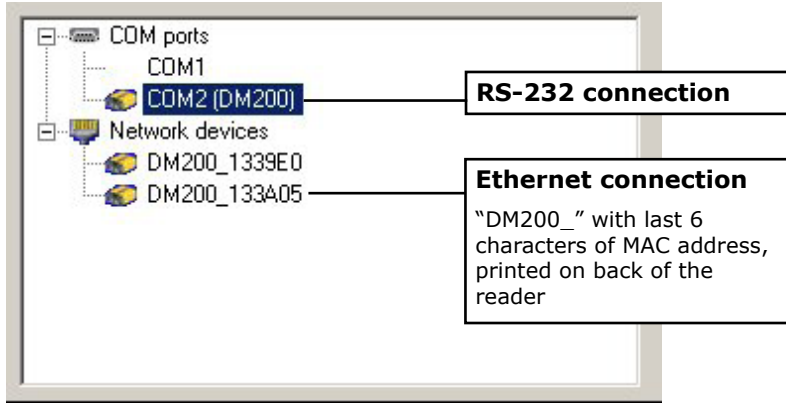

## Troubleshooting an Ethernet Connection

Based on your network configuration, the Setup Tool may not be able to communicate with the reader and it will not appear in the list of **Network devices**.

First check your Ethernet connection with the reader and click **Refresh** in the Setup Tool. Next, scan the **Enable DHCP** code in the DM200 Configuration Codes document available from the Start menu. This might allow the reader to acquire a suitable IP address from a DHCP server on your subnet.

If the reader still does not appear, you can use either the **Add Device** or **Force Network Settings** options in the Setup Tool.

If you know the IP address of the reader, use the **Add Device** option. If you do not know the IP address, use the **Force Network Settings** options. Either method should allow the DataMan 200 reader to appear in the list of **Network devices** so that you can connect to it through the Setup Tool and your Ethernet connection.

# Start the Setup Tool

Connect the reader to the Setup Tool to configure it with the type of symbologies it will decode as well as other parameters, such as the type of trigger it will use and the format of the results it will generate.

## Connect to Reader

Establish a connection to the reader

## Results Display

View results

## Light and Camera Settings

Choose a trigger type and other acquisition parameters

## System Settings

Configure input and output signals

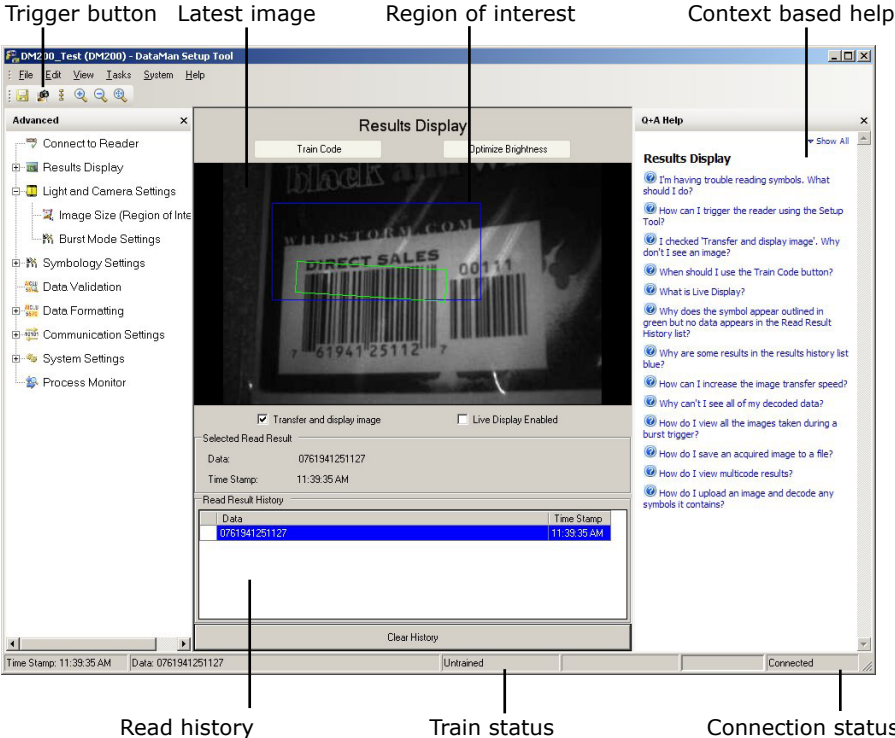



## Use the Setup Tool General Toolbar

Each reader can store its current set of run-time parameters to a configuration (.cfg) file, which contains information such as the enabled symbologies and how any output data should be formatted.

The same configuration file can be loaded onto multiple readers, as the file does not contain identification information such as the IP address or device name of the reader used to create it.

A reader can also generate a Cognex device configuration (.cdc) file, which stores the set of run-time parameters plus any identification data, such as the name of the device, its IP address, subnet mask, and so on. Cognex recommends generating a device configuration file for each reader to allow you to restore a reader to its operating state with minimal effort.

Use the **File** menu of the Setup Tool to manage .cfg and .cdc files:

### File Menu

Open Configuration	Open a saved .cfg configuration file.
Save Configuration	Create a .cfg configuration file of current run-time parameters.
Print Configuration Code	Not supported on the DataMan 200.
Restore Device	Load a saved device configuration .cdc file, with run-time parameters plus device-specific information for a particular DataMan 200.
Backup Device	Create a device configuration .cdc file for a specific reader.
Load Image	Load an 8-bit uncompressed grey-scale .bmp or .jpg image for analysis.

Save Image	Save the latest acquired image with the .jpg or .bmp file format.
------------	---

Save Burst Images	Save the latest batch of burst images.
-------------------	--

Use the **Edit** menu for standard Cut, Copy and Paste operations.

Use the **View** menu to view reader information (serial number, firmware version, and so on) and to enable and disable various elements of the Setup Tool, and the **Tasks** menu to switch between various Setup Tool options.

Use the **System** menu to manage the current settings on the reader and to upgrade the features it currently supports:

### System Menu

Save Settings	Save the current parameters to non-volatile memory, which allows the reader to restore these settings each time you reboot it.
Reset Configuration	Reset all configuration parameters in RAM (volatile memory) to the default settings.
Update Firmware	Update the reader software.
Upload Feature Key	Unlock additional features available in the reader software if you have the right key.
VeriCode License	Add VeriCode decoding by entering a license string provided by Veritek. Ask your Cognex sales representative for details.

Use the **Help** menu to display Setup Tool version information.

# DataMan 200 Triggering

Trigger the reader using any of the following methods:

- Press the trigger button on the reader.
- Send a pulse on the I/O cable:  
Trigger + (blue), Trigger - (black)
- Send a trigger command over the RS-232 connection or Ethernet connection.
- Click the Trigger button in the Setup Tool:



- Press <CTRL>-T on the keyboard.



# Trigger Modes

DataMan supports a variety of trigger modes:

- **Single:** Acquires a single image and attempts to decode any symbol it contains, or more than one symbol in cases where multicode is enabled. The reader relies on an external trigger source.
- **Presentation:** Repeatedly scans for a symbol and decodes it whenever one is detected. The reader relies on an internal timing mechanism to acquire images.
- **Manual (default):** Begins acquiring images when you press the trigger button on the reader, and continues acquiring images until a symbol is found and decoded or you release the button.
- **Burst:** Performs multiple image acquisitions based on an external trigger and decodes any symbol appearing in a single image or within a sequence of images, or multiple symbols in a single image or within a sequence of images when multicode is enabled. You can control the number of images within each burst and the interval between image acquisitions.
- **Self:** Similar to Presentation mode in that the reader perpetually scans for symbols and decodes them each time one is detected. Unlike Presentation mode, however, Self mode supports multicode results and a decode attempt occurs with every image.
- **Continuous:** Begins acquiring images based on a single external trigger and continues to acquire images until a symbol is found and decoded, or until multiple images containing as many codes as specified in multicode mode are located, or until the trigger is released.

# Training the Reader

Training your reader with the expected symbology can decrease the time required to decode successive symbols. Train your reader by placing a code in front of it and doing one of the following:

- Press and hold the trigger button for a minimum of 3 seconds.



- Click and hold the trigger button in the Setup Tool for a minimum of 3 seconds.

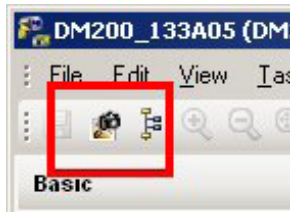

- Click **Train Code** in the Results Display pane.

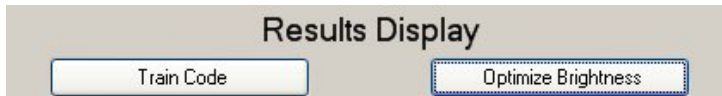

Training is supported for the Single, Burst, Continuous and Self trigger modes.

## Training Feedback

The middle LED on the reader glows green to indicate that it is currently trained, or yellow to indicate that it is not trained.



Connect the reader to the Setup Tool to untrain it and allow it to recognize other enabled symbologies.

## Incremental Training for Multiple Symbologies

If you want to train the reader to recognize multiple symbologies, you can present a single image showing all the desired symbologies and perform the training procedure previously described.

If you cannot present a single image showing all the necessary symbologies, you can enable incremental training on the **Training** tab of the **Symbology Settings** pane:

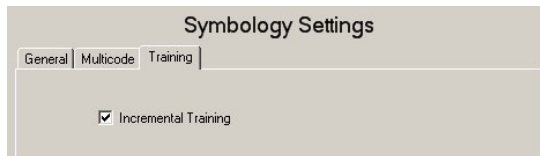

With incremental training enabled, you can train the reader using multiple images showing the symbologies you expect to decode. The reader will train each new symbology while retaining the existing trained symbologies.

## C-Mount Option

The DataMan 200 is available with an optional C-mount in place of the integrated lens assembly.

- The C-mount option is only available as a build option. You cannot remove or install the C-mount yourself.
- Internal illumination and aiming are not available with the C-mount option.
- To prevent damage to your DataMan 200, do not leave the sensor exposed. Make sure that either the supplied protective cover or a lens is in place at all times.
- Not all C-mount lenses are compatible with the DataMan 200. The lenses must meet the requirements listed below.

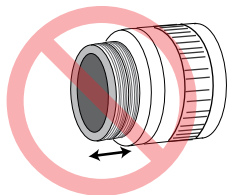

Threads must be no more than 4mm deep.

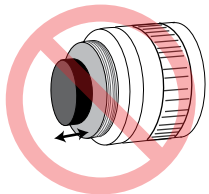

Nothing must protrude past the end of the threads.

## Installing a C-Mount Lens

- 1 Remove and save the protective cover.

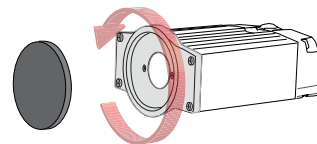
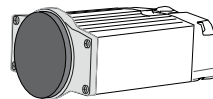

- 2 Install lens

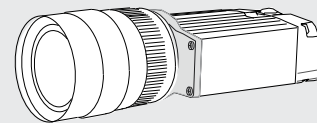
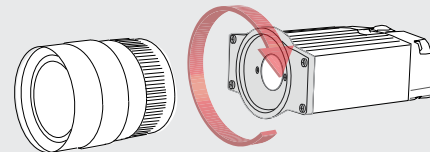

## Liquid Lens

---

The DataMan 200 is available with a Liquid Lens option - an electronically controllable variable focus system.

The Liquid Lens offers rapid, hands-free, software-driven autofocus with no moving parts and an increased depth of field flexibility.

The Liquid Lens is available pre-installed or retrofitted to a standard model. Contact your Cognex sales representative for more information.



## EtherNet/IP Support

---

The DataMan 200 supports EtherNet/IP™, a proven and complete industrial Ethernet network solution available for manufacturing applications involving control, safety, synchronization, motion, configuration, and information. EtherNet/IP provides an extensive range of messaging options and services for the transfer of data and I/O over Ethernet.

Enable EtherNet/IP using the **Network Settings** tab of the Setup Tool:

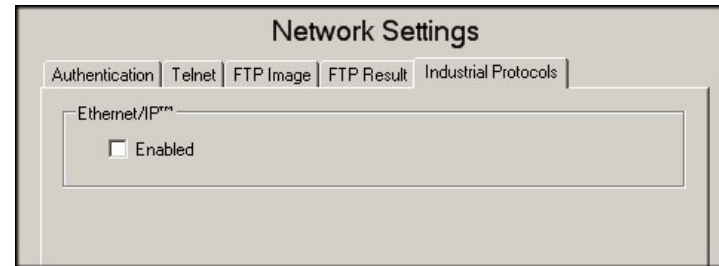

For more information on using EtherNet/IP, read the DataMan EtherNet/IP document available from the Start menu.

# I/O Cable

The I/O cable provides access to trigger and high-speed outputs.

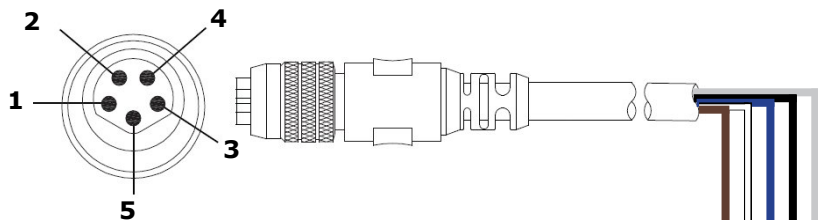

Pin #	Signal Name	Wire Color
1	High Speed Out 0	Brown
2	High Speed Out 1	White
3	Trigger +	Blue
4	Trigger -	Black
5	Common Out	Grey

Unused bare wires can be clipped short or tied back using a tie made of non-conductive material.

# Acquisition Triggering

The acquisition trigger input on the reader is opto-isolated. To trigger from an NPN (pull-down) type photo-detector or PLC output, connect TRG+ to +24V and connect TRG- to the output of the detector. When the output turns on, it pulls TRG- down to 0V, turning the opto-coupler on.

To trigger from a PNP (pull-up) photo-detector or PLC output, connect TRG+ to the output of the detector and connect TRG- to 0V. When the output turns on, it pulls TRG+ up to 24V, turning the opto-coupler ON.

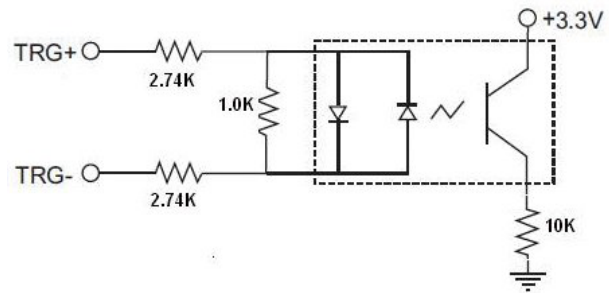

28V Max. Across input pins - Transition approx. 12V (Min).

# High-Speed Output Lines

The high-speed outputs can be used as either NPN (pull-down) or PNP (pull-up) lines. For NPN lines, the external load should be connected between the output and the positive supply voltage (<28V). The outputs pull down to less than 3V when ON, which causes current to flow through the load. When the outputs are OFF, no current flows through the load.

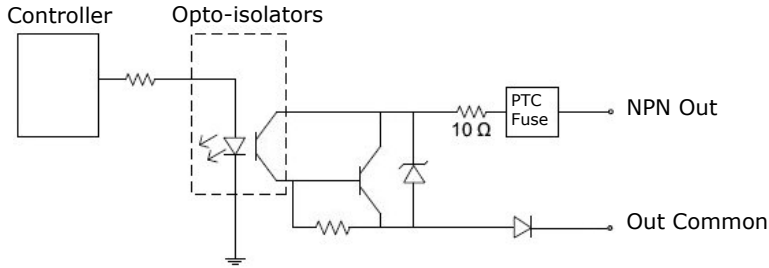

For PNP lines, the external load should be connected between the output and the negative supply voltage (0V). When connected to a 24VDC power supply, the outputs pull up greater than 21V when ON, and current flows through the load. When the outputs are OFF, no current flows through the load.

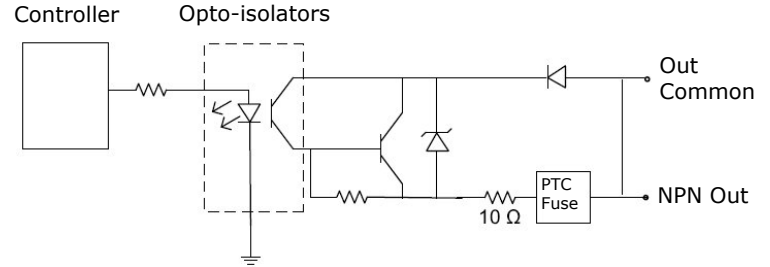

Specification	Description
Voltage	28V maximum through external load
Current	50mA maximum sink current
	OFF state leakage current 100µA
	External load resistance 240 Ohms to 10K Ohms
	Each line rated at a maximum 50mA, protected against over-current, short circuits and transients from switching inductive loads. High current inductive loads require external protection diode.

# High Speed Output Wiring

To connect to an NPN-compatible PLC input, connect Output 0 or Output 1 directly to the PLC input. When enabled, the output pulls the PLC input down to less than 3V.

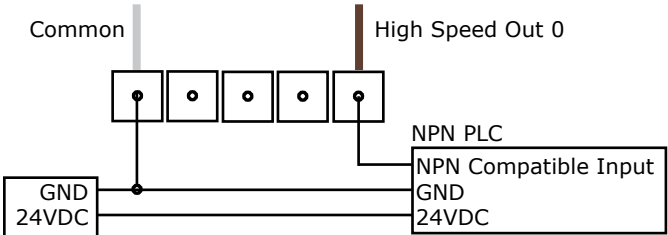

To connect to a PNP-compatible PLC input, connect Output 0 or Output 1 directly to the PLC input. When enabled, the output pulls the PLC input up to greater than 21V.

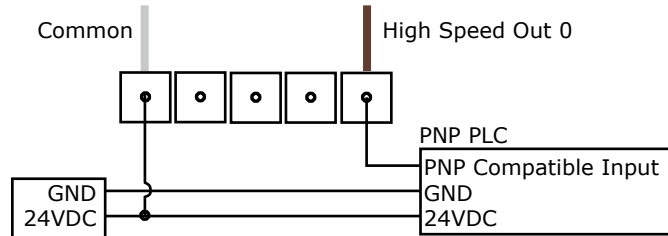

To connect the high-speed outputs to a relay, LED or similar load, connect the negative side of the load to the output and the positive side to +24V. When the output switches on, the negative side of the load is pulled down to less than 3V, and 24 appears across the load. Use a protection diode for a large inductive load, with the anode connected to the output and the cathode connected to +24V.

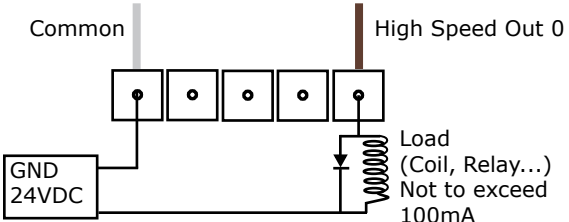



# RS-232 Cable

The RS-232 cable provides an optional connection between the reader and your PC.

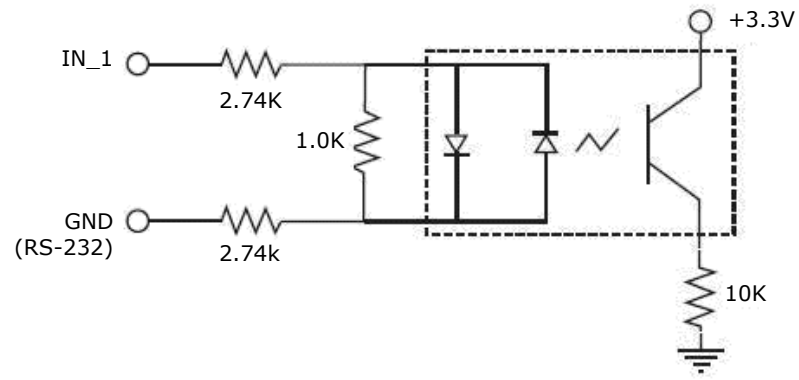
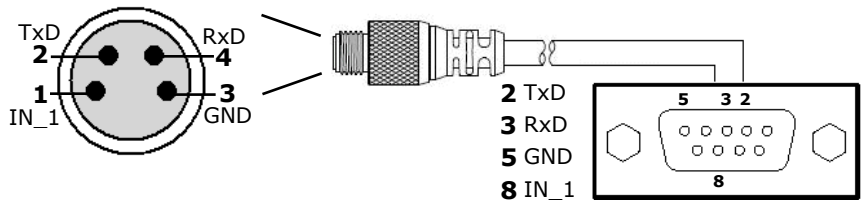

28V Max. Across input pins - Transition approx. 12V (Min)

# DataMan 200 Specifications

Weight	75 g	
Operating Temperature	0°C — 40°C (32°F — 104°F)	
Storage Temperature	-10°C — 60°C (-14°F — 140°F)	
Maximum Humidity	95% (non-condensing)	
Environmental	IP65 (with cable or protection cap attached to all three connectors) None (C-mount option)	
Vibration	EN61373 including IEC 60068-2-6, 60068-2-64 6.4, and 60068-2-27	
Codes	Data Matrix™ (IDMax: ECC 0, 50, 80, 100, 140, and 200; IDQuick: ECC200) Vericode (optional) QR Code and microQR Code UPC/EAN/JAN Codabar, Interleaved 2 of 5, Code 39, Code 128, and Code 93, Pharma, Postal, RSS/CS, PDF 417, MicroPDF 417	
Discrete I/O operating limits	Trigger, HS Output 0,1	Max output current: 50 mA @ 28 VDC Output load: 470 Ω @ 24 VDC; 150 Ω @ 12 VDC Input voltage limits: - 28 VDC — +28 VDC Input current: 4.2 mA @ 24 VDC; 2.0 mA @ 12 VDC
Power Supply Requirements	PoE injector	Class 1 or 48VDC 2.0W Max LPS

# Multi-Port Connections

You can connect multiple DataMan 200 readers to a single PC (or other device equipped with a serial port) using a multi-port connection.

A multi-port connection creates a daisy-chain of readers. Each reader receives serial data from the previous reader and transmits it to the next reader. When a reader transmits data, it is passed through each of the readers in the chain between it and the PC.

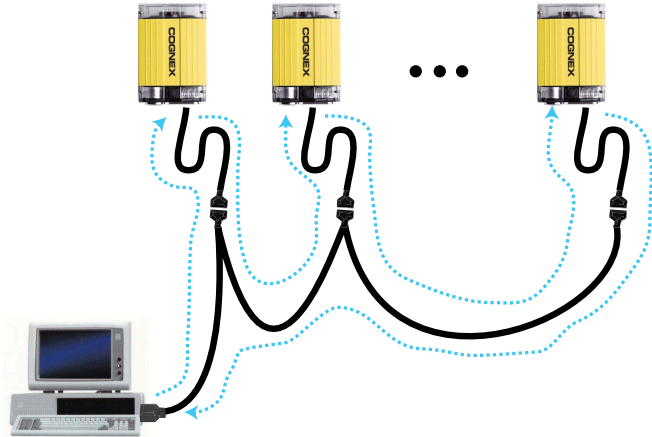

Because of the large number of possible configurations, Cognex does not supply cabling for multi-port DataMan 200 connections. Instead, you must construct your own cable that meets the requirements of your system configuration.

The cable must provide a DB-9 connector for each DataMan 200 serial cable and a DB-9 connector for the PC serial port. Each DB-9 connector must provide Tx Data, Rx Data, and ground. The Tx Data and Rx Data pins on adjacent connectors must be connected to provide the multi-port connection.

The following diagram shows how to create a multi-port cable for a 3-reader system:

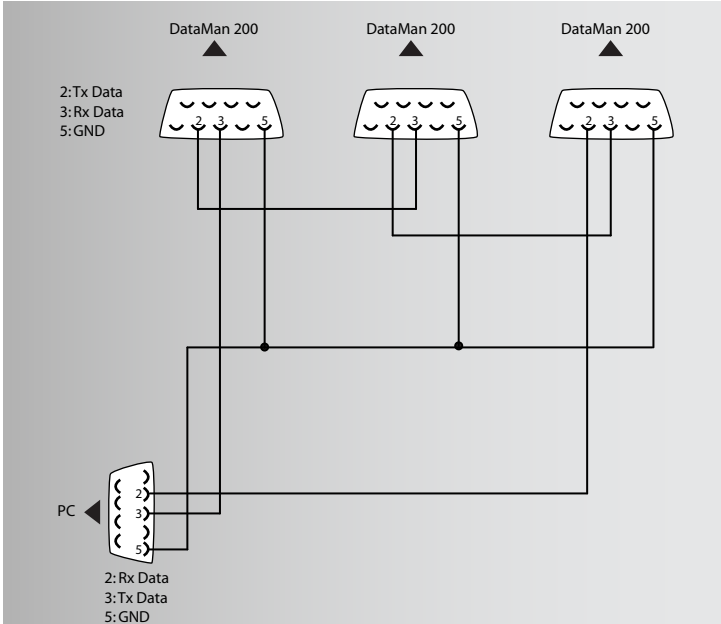

## Configuring for Multi-Port Operation

You must connect the Setup tool to each DataMan 200 in turn and enable multi-port operation. Click the **Communication Settings** task and check the **Enable Multi-Port (RS-232 Sharing)** check box.

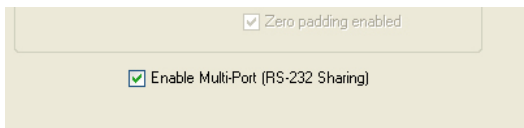

There is no guaranteed delivery order when multiple readers transmit data using a multi-port connection; read results may arrive at the PC in any order. You can configure each DataMan 200 reader in a multi-port connection to add identifying data to each read result. Your PC application can then determine which reader produced a specific read result.

To do this, click on the **Data Formatting** task, check the **Standard Formatting Enabled** box (for each symbology that you are using), and enter text in the **Leading Text** field. (You can also add trailing text by entering text in the **Trailing Text** field.)

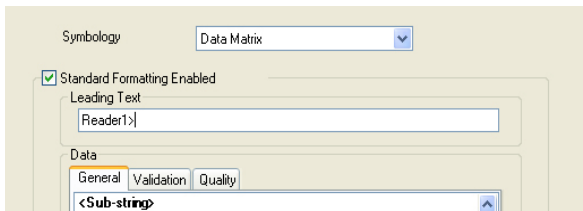

## Multi-Port Usage Notes

You can obtain the best results when using multi-port connections by keeping the following usage guidelines in mind as you design your system:

- The maximum cable length between any two DataMan readers or between the PC and any DataMan reader should be no greater than 15 meters.
- There is no fixed limit to the number of DataMan readers that you can connect to a single PC. Each reader introduces a delay of about 100 msec when it retransmits received serial data. If you have 5 readers, this means that there will be a 400 msec delay between the time the first reader in the chain transmits data and the PC receives it.
- Each DataMan reader must receive a hardware trigger signal on its Input 0 line. You can wire the input ports to a common trigger signal or you can provide individual triggers for each reader.
- If *any* reader in the multi-port chain loses power or becomes disconnected, then no data from any other reader will be transmitted.
- If a DataMan is transmitting its own read result, it will buffer any data received from another reader until it has finished its own data transmission. If a DataMan reader is transmitting another reader's data, it will buffer its own data if it receives a trigger signal while it is processing the other reader's data.
- If you use a single power supply for multiple readers, make sure that the power supply can provide enough power for all of the readers.
- You cannot connect a reader to the Setup Tool over RS-232 once multiport is enabled. You must first scan the Disable Multi-Port code from the Reader Configuration Codes, available from the Start menu.

## Compliance Notice

The DataMan 200 series meets or exceeds the requirements of all applicable standards organizations for safe operation. However, as with any electrical equipment, the best way to ensure safe operation is to operate them according to the agency guidelines that follow. Please read these guidelines carefully before using your device.

Regulator	Specification
USA	FCC Part 15, Class A FDA/CDRH Laser Notice No 50
Canada	ICES-003
European Community	EN55022:2006 +A1:2007, Class A EN55024:1998 +A1:2001 +A2:2003 EN60950 EN60825-1
Australia	C-TICK, AS/NZS CISPR 22 / EN 55022 for Class A Equipment
Japan	J55022, Class A

### FCC Class A Compliance Statement



This equipment has been tested and found to comply with the limits for a Class A digital device, pursuant to Part 15 of the FCC rules. These limits are designed to provide reasonable protection against harmful interference when the equipment is operated in a commercial environment. This equipment generates, uses, and can radiate

radio frequency energy and, if not installed and used in accordance with the instructions, may cause harmful interference to radio communications. Operation of this equipment in a residential area is likely to cause harmful interference, in which case the user will be required to correct the interference at personal expense.

### Canadian Compliance

This Class A digital apparatus complies with Canadian ICES-003.  
Cet appareil numérique de la classe A est conforme à la norme NMB-003 du Canada.

### C-Tick Statement



Conforms to AS/NZS CISPR 22/ EN 55022 for Class A Equipment.

### European Compliance



The CE mark on the product indicates that the system has been tested to and conforms to the provisions noted within the 2004/108/EEC Electromagnetic Compatibility Directive and the 2006/95/EEC Low Voltage Directive.

For further information please contact:

Cognex Corporation  
One Vision Drive  
Natick, MA 01760  
USA

Cognex Corporation shall not be liable for use of our product with equipment (i.e., power supplies, personal computers, etc.) that is not CE marked and does not comply with the Low Voltage Directive.

### Laser Safety Statement



Compliance with FDA performance standards for laser products except for deviations pursuant to Laser Notice No. 50, dated July 26, 2001.

This device has been tested in accordance with IEC60825-1 2nd ed., and has been certified to be under the limits of a Class 2 Laser device.

Use of controls or adjustments or performance of procedures other than those specified herein may result in hazardous radiation exposure.



### UL and cUL Statement



UL and cUL listed: UL60950-1 1st ed. and CSA C22.2 No.60950-1 1st ed.

### For European Community Users

Cognex complies with Directive 2002/96/EC OF THE EUROPEAN PARLIAMENT AND OF THE COUNCIL of 27 January 2003 on waste electrical and electronic equipment (WEEE).

This product has required the extraction and use of natural resources for its production. It may contain hazardous substances that could impact health and the environment, if not properly disposed.

In order to avoid the dissemination of those substances in our environment and to diminish the pressure on the natural resources, we encourage you to use the appropriate take-back systems for product disposal. Those systems will reuse or recycle most of the materials of the product you are disposing in a sound way.





The crossed out wheeled bin symbol informs you that the product should not be disposed of along with municipal waste and invites you to use the appropriate separate take-back systems for product disposal.

If you need more information on the collection, reuse, and recycling systems, please contact your local or regional waste administration.

You may also contact your supplier for more information on the environmental performance of this product.

## Warnings and Notices

 CAUTION: This device requires the use of a PoE Class 1 or 48V DC LPS power supply.

 NOTE: For product support, contact <http://support.cognex.com>

 CAUTION: IP protection is ensured only when all connectors are attached to cables or shielded by a sealing cap.



**LASER LIGHT, DO NOT STARE INTO BEAM: CLASS 2 LASER PRODUCT**  
**FAILURE TO FOLLOW THESE INSTRUCTIONS MAY CAUSE SERIOUS INJURY**

- Use of controls or adjustments or performance of procedures other than those specified herein may result in hazardous radiation exposure.
- Do not attempt to service or repair this product -- return it to Cognex for service.
- Do not permit anyone other than Cognex Corporation or Cognex-authorized personnel to service, repair, or adjust this product.
- Do not attempt to open or modify this device except as described in this document.
- Do not direct or reflect laser light toward people or reflective objects.
- Do not operate this device if it is damaged or if the covers or seals are missing or damaged.

This Laser Product is designated as Class 2 during all procedures of operation.

Wavelength	650 nm
Laser Power for classification	< 1 mW
Beam Diameter	< 3mm at aperture
Divergence	< 1.5 mrad

**For assistance contact Cognex Corporation at <http://support.cognex.com>**

# Reader Control Codes

---



Hard Reset



Soft Reset

Copyright © 2010 Cognex Corporation All Rights Reserved. This document may not be copied in whole or in part, nor transferred to any other media or language, without the written permission of Cognex Corporation. The hardware and portions of the software described in this document may be covered by one or more of the U.S. patents listed on the Cognex web site <http://www.cognex.com/patents.asp>. Other U.S. and foreign patents are pending. Cognex, the Cognex logo, and DataMan are trademarks, or registered trademarks, of Cognex Corporation.



P/N 590-7111