

## SMALL SERIES

The new **SMall** series offers a complete line of subminiature amplified photoelectric sensors, ideal for mounting in reduced spaces or in presence of particular mechanical obstacles.

The extremely compact dimensions and wide detection field of all modes suit most of the applications on automatic machinery for packaging, assembling, printing as well as in automatic distribution and vending machines.

The series offers many different optic functions including 1.5 m retroreflex, 1 m polarised retroreflex, and 2 m through beam. The 15 mm, 20 mm, 30 mm and 50 mm fixed focus proximity models represent a valid alternative to fibre-optic systems and can be used to detect objects with small profiles and poorly reflective materials.

All models of the subminiature **SMall** series have visible red emission facilitating alignment, cable connection and are available in the NPN or PNP versions with NO-NC double output. The plastic housing guarantees an IP67 protection degree.



## HIGHLIGHTS

- 15 mm, 20 mm, 30 mm and 50 mm fixed focus proximity
- 1.5 m retroreflex and 1 m polarised retroreflex
- 2 m through beam models
- Amplified NPN or PNP output with NO-NC double output

## APPLICATIONS

Automotive



Beverage & Bottling



Packaging lines



The range offers versions with PNP or NPN output and each are available with a normally open and normally closed output. The sensor functions in the light mode if the normally open output is used and is activated, like the output LED, in presence of light. The opposite effect is obtained when the sensor functions in dark mode and the normally closed output is used. In presence of short-circuit output, the green LED blinks signalling the fault.

## DIMENSIONS

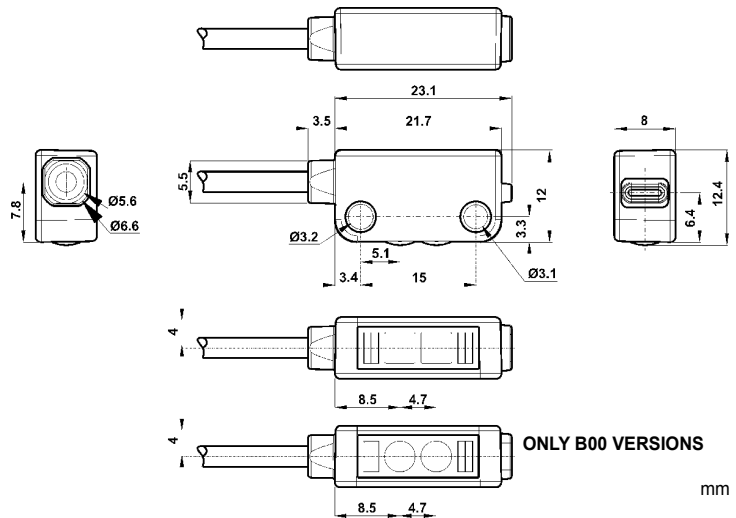

## CONNECTIONS

### SM-PR-2-F00/A00/B00/Dxx

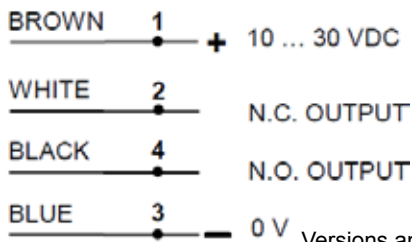

### SM-PR-2-G00

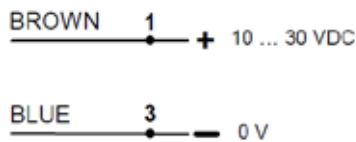

Versions and options: refer to MODEL SELECTION TABLE

## INDICATORS AND SETTINGS

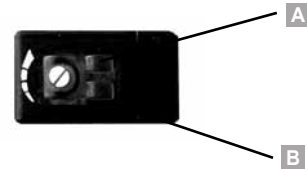

- A Output status LED
- B Power on LED

## DETECTION DIAGRAMS

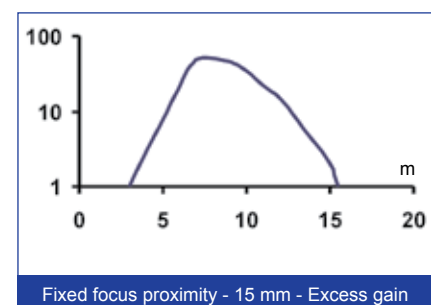
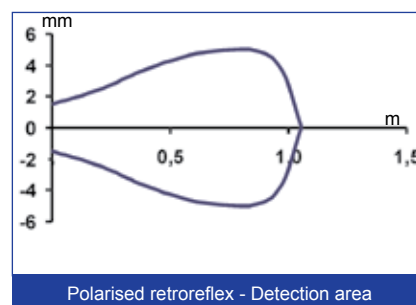
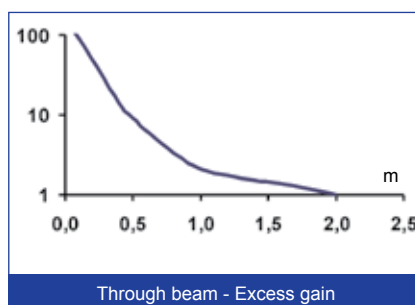
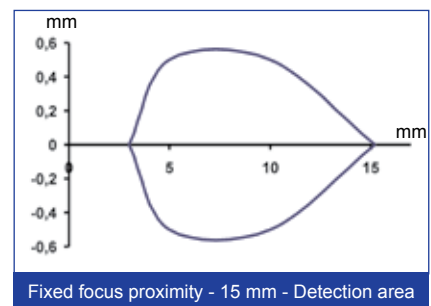
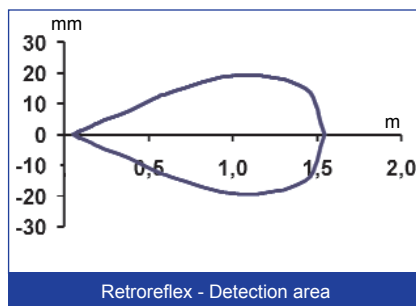
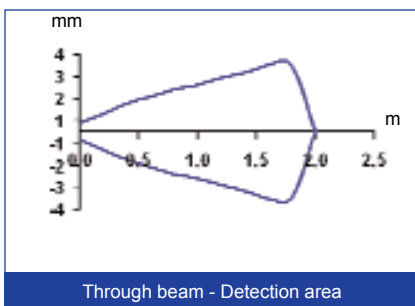

**TECHNICAL DATA**

**SELECTION TABLE**

TECHNICAL NOTES		SM-PR-2-G00-XG	SM-PR-2-F00-PP	SM-PR-2-F00-NN	SM-PR-2-A00-PP	SM-PR-2-A00-NN	SM-PR-2-B00-PP	SM-PR-2-B00-NN	SM-PR-2-D00-PP	SM-PR-2-D00-NN	SM-PR-2-D10-PP	SM-PR-2-D10-NN	SM-PR-2-D20-PP	SM-PR-2-D20-NN	SM-PR-2-D30-PP	SM-PR-2-D30-NN
		•	•	•	•	•	•	•	•	•	•	•	•	•	•	•
<b>Power supply:</b>	10 ... 30 Vdc <sup>2</sup>	•	•	•	•	•	•	•	•	•	•	•	•	•	•	•
<b>Consumption:</b>	20 mA max.	•	•	•	•	•	•	•	•	•	•	•	•	•	•	•
<b>Light emission:</b>	red LED 640 nm	•	•	•	•	•	•	•	•	•	•	•	•	•	•	•
<b>Through beam operating distance:</b>	0 ... 2 m	•	•	•												
<b>Retroreflex operating distance:</b>	5 ... 150 cm				•	•										
<b>Polarised retroreflex operating distance:</b>	10 ... 100 cm						•	•								
<b>Fixed focus operating distance:</b>	3 ... 15 mm <sup>1</sup>								•	•						
	3 ... 20 mm										•	•				
	3 ... 30 mm												•	•		
	3 ... 50 mm														•	•
<b>Indicators:</b>	yellow OUTPUT LED	•	•	•	•	•	•	•	•	•	•	•	•	•	•	•
	green POWER LED	•	•	•	•	•	•	•	•	•	•	•	•	•	•	•
<b>Output type:</b>	PNP, NO-NC		•		•		•		•		•		•		•	
	NPN, NO-NC			•		•		•		•		•		•		•
<b>Operating mode:</b>	light on NO, dark on NC	•	•	•	•	•	•	•	•	•	•	•	•	•	•	•
<b>Saturation voltage:</b>	1.45 V max. at 50 mA	•	•	•	•	•	•	•	•	•	•	•	•	•	•	•
<b>Output current:</b>	50 mA max.	•	•	•	•	•	•	•	•	•	•	•	•	•	•	•
<b>Response time:</b>	0.7 ms				•	•	•	•	•	•	•	•	•	•	•	•
	1.3 ms	•	•	•												
<b>Switching frequency:</b>	700 Hz				•	•	•	•	•	•	•	•	•	•	•	•
	385 Hz	•	•	•												
<b>Connection:</b>	2 m cable, Ø 2.5 mm	•	•	•	•	•	•	•	•	•	•	•	•	•	•	•
<b>Electrical protection:</b>	class 2	•	•	•	•	•	•	•	•	•	•	•	•	•	•	•
<b>Mechanical protection:</b>	IP67	•	•	•	•	•	•	•	•	•	•	•	•	•	•	•
<b>Protection devices:</b>	A, B <sup>3</sup>	•	•	•	•	•	•	•	•	•	•	•	•	•	•	•
<b>Housing material:</b>	Polycarbonate	•	•	•	•	•	•	•	•	•	•	•	•	•	•	•
<b>Lens material:</b>	PMMA	•	•	•	•	•			•	•	•	•	•	•	•	•
	glass						•	•								
<b>Weight:</b>	22 g	•	•	•	•	•	•	•	•	•	•	•	•	•	•	•
<b>Operating temperature:</b>	-20 ... +55°C	•	•	•	•	•	•	•	•	•	•	•	•	•	•	•
<b>Storage temperature:</b>	-30 ... +75°C	•	•	•	•	•	•	•	•	•	•	•	•	•	•	•
<b>Reference standard:</b>	EN 60947-5-2	•	•	•	•	•	•	•	•	•	•	•	•	•	•	•

through beam		
SM-PR-2-G00-XG		95B000160
SM-PR-2-F00-PP	PNP	95B000120
SM-PR-2-F00-NN	NPN	95B000130

retroreflex		
SM-PR-2-A00-PP	PNP	95B000060
SM-PR-2-A00-NN	NPN	95B000070

polarised retroreflex		
SM-PR-2-B00-PP	PNP	95B000080
SM-PR-2-B00-NN	NPN	95B000090

fixed focus proximity - 15 mm		
SM-PR-2-D00-PP	PNP	95B000020
SM-PR-2-D00-NN	NPN	95B000030

fixed focus proximity - 20 mm		
SM-PR-2-D10-PP	PNP	95B000140
SM-PR-2-D10-NN	NPN	95B000150

fixed focus proximity - 30 mm		
SM-PR-2-D20-PP	PNP	95B000040
SM-PR-2-D20-NN	NPN	95B000050

fixed focus proximity - 50 mm		
SM-PR-2-D30-PP	PNP	95B000000
SM-PR-2-D30-NN	NPN	95B000010



**DETECTION DIAGRAMS**

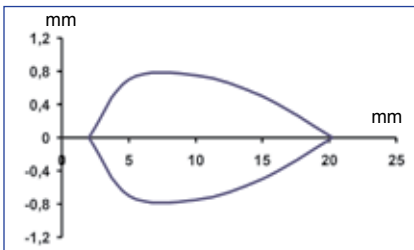

Fixed focus proximity - 20 mm - Detection area

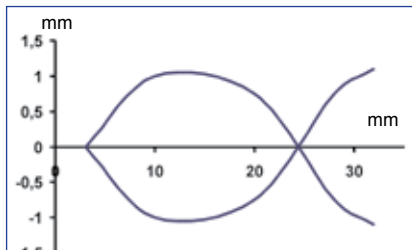

Fixed focus proximity - 30 mm - Detection area

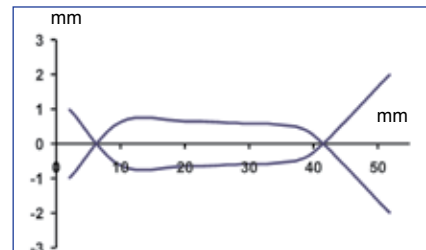

Fixed focus proximity - 50 mm - Detection area

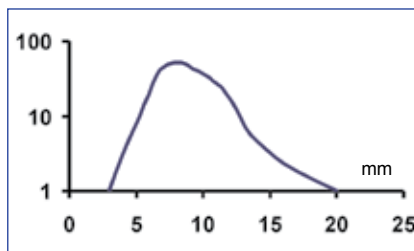

Fixed focus proximity - 20 mm - Excess gain

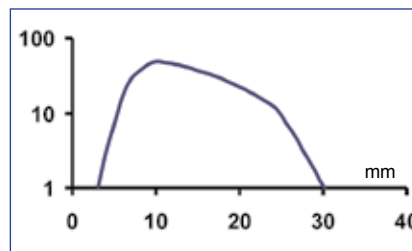

Fixed focus proximity - 30 mm - Excess gain

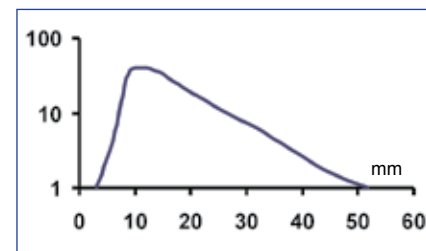

Fixed focus proximity - 50 mm - Excess gain

## MODEL SELECTION AND ORDER INFORMATION

MODEL	FUNCTION	OUTPUT	ORDER N°
SM-PR-2-G00-XG	emitter	-	95B000160
SM-PR-2-F00-PP	receiver	PNP	95B000120
SM-PR-2-F00-NN	receiver	NPN	95B000130
SM-PR-2-A00-PP	retroreflex	PNP	95B000060
SM-PR-2-A00-NN	retroreflex	NPN	95B000070
SM-PR-2-B00-PP	polarised retroreflex	PNP	95B000080
SM-PR-2-B00-NN	polarised retroreflex	NPN	95B000090
SM-PR-2-D00-PP	15 mm fixed focus proximity	PNP	95B000020
SM-PR-2-D00-NN	15 mm fixed focus proximity	NPN	95B000030
SM-PR-2-D10-PP	20 mm fixed focus proximity	PNP	95B000140
SM-PR-2-D10-NN	20 mm fixed focus proximity	NPN	95B000150
SM-PR-2-D20-PP	30 mm fixed focus proximity	PNP	95B000040
SM-PR-2-D20-NN	30 mm fixed focus proximity	NPN	95B000050
SM-PR-2-D30-PP	50 mm fixed focus proximity	PNP	95B000000
SM-PR-2-D30-NN	50 mm fixed focus proximity	NPN	95B000010

## ACCESSORY SELECTION AND ORDER INFORMATION

MODEL	FUNCTION	ORDER N°
ST-5049	L-shaped fixing bracket	95ACC6650

## ACCESSORY DIMENSIONS

ST-5049

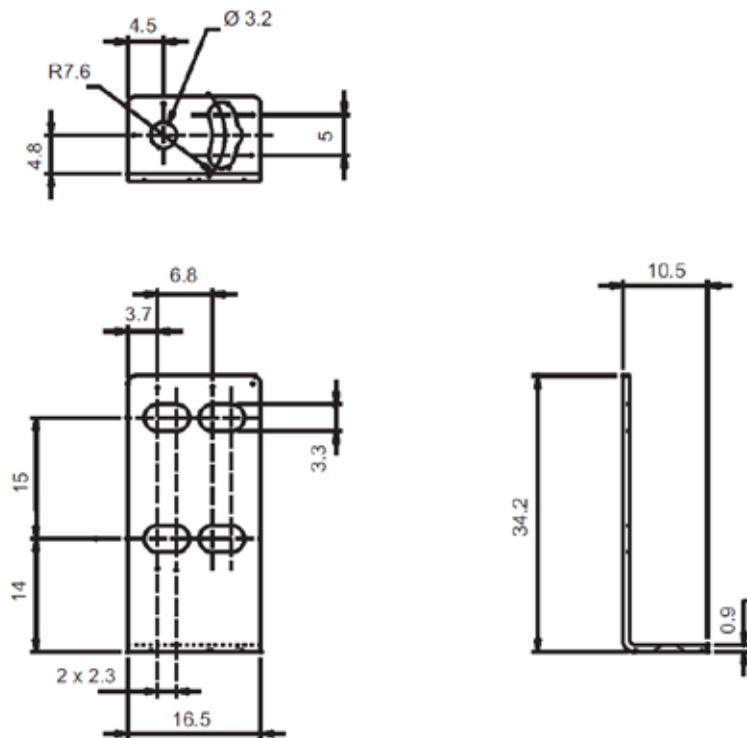

mm



The company endeavours to continuously improve and renew its products; for this reason the technical data and contents of this catalogue may undergo variations without prior notice. For correct installation and use, the company can guarantee only the data indicated in the instruction manual supplied with the products.