

Non-Contact Thermometer

# Instruction Manual

***THERMO-HUNTER BUILT-IN***

**CS-30TAC, CS-40TAC**

**CS-30TAC-HT, CS-40TAC-HT**



**OPTEX FA CO., LTD.**

91 Chudoji-Awata-cho Shimogyo-ku Kyoto  
600-8815 JAPAN

TEL: +81-75-325-1314 FAX: +81-75-325-2936

Printed in JAPAN 1941-4 2013/09

Thank you very much for purchasing OPTEX products.

This device is a non-contact thermometer to convert the infrared energy emitted from the surface of an object into temperature. This thermometer measures the surface temperature of solid and liquid without contacting them. The temperature of gas cannot be measured by this thermometer.

## Contents

Introduction.....	2
Safe Usage.....	3
Warnings & Caution on Environment and Usage .....	3
Specifications .....	4
External Dimensions/Parts Name.....	5
Wiring Diagram.....	6
Mounting/Installation.....	8
Field of View .....	9
How to Use .....	10
Function List .....	11
Setup of Functions.....	12
BANK mode .....	12
DELY mode.....	12
TADJ mode .....	12
ASCL mode.....	15
ALAM mode .....	16
TRIG mode .....	18
ECO mode .....	21
END mode .....	21
Troubleshooting .....	22
Maintenance .....	22

### Introduction

- Please make sure the model you purchased is the one you specified.
- Please read the manual thoroughly before using the device for correct usage.
- After reading this manual, please retain it for future reference.
- OPTEX is not liable for any incidental or consequential damages or losses including losses of data or changes of measurement, arising from accident, misuse or abnormal conditions of operation or handling.

# Safe Usage

This instruction manual contains various warnings for your safety and proper usage to avoid possible personal injury. Please be sure to heed the warnings and strictly follow safety instructions.



## Caution

This symbol signifies that improper usage may result in injuries or damage.



## Caution

This product is not a clinical thermometer and therefore, cannot be used for medical purposes.



## Caution

Use of controls or adjustments or performance of procedures other than those specified herein may result in hazardous radiation exposure.

## Environmental Warnings - Warning - Caution



**DO NOT USE THERMOMETER WHEN IT IS WET OR SOAKED IN LIQUID.**  
Although the product is water-resistant, using it with water drops on its lens or in wet conditions may cause incorrect measurement.



**KEEP THE THERMOMETER AWAY FROM DIRECT SUNLIGHT, DUST, HIGH TEMPERATURES AND HIGH HUMIDITY DURING USE AND STORAGE.**  
This may cause irreparable damage or incorrect measurement.



**KEEP THE THERMOMETER AWAY FROM SUDDEN CHANGE IN AMBIENT TEMPERATURE.**  
Sudden temperature change may cause incorrect measurement. Start measurement when temperature has become stable after leaving the meter for a while.



**KEEP THE THERMOMETER AWAY FROM PRODUCTS WHICH PRODUCE STRONG ELECTROMAGNETIC WAVES. DO NOT USE IN AN ATMOSPHERE CONTAINING CORROSIVE GASES OR EXPLOSIVE GASES.**  
This may cause irreparable damage or incorrect measurement.

## Usage Warnings - Warning - Caution



**AVOID MEASURING SHINY OBJECTS.**  
Shiny objects reflect surrounding temperatures. Incorrect measurement may occur although specifying the emissivity rate can correct it.



**DO NOT DROP THIS THERMOMETER NOR GIVE A STRONG IMPACT TO IT, WHICH MAY CAUSE IRREPARABLE DAMAGE OR INCORRECT MEASUREMENT.**  
This may cause irreparable damage or incorrect measurement.



**DO NOT USE WITH NON-STANDARD VOLTAGE.**  
Using the unit out of 12 to 24 VDC range may result in damage to the unit, shorts, fires and injuries. In such cases, immediately switch the unit off.



**DO NOT LET THE THERMOMETER TOUCH THE OBJECT THAT IS BEING MEASURED.**  
This product is a non-contact thermometer. Touching high-temperature object may cause deformation of the meter, irreparable damage or incorrect measurement.



**DO NOT TOUCH THE LENS.**  
Do not touch the lens with hard or sharp objects. Do not insert foreign objects into the light receiving part. Otherwise incorrect measurement will occur.



**DO NOT BRING THE THERMOMETER CLOSE TO ELECTRICALLY CHARGED OBJECTS.**  
This may cause irreparable damage or incorrect measurement.

# Specifications

Model	CS-30TAC-HT	CS-40TAC-HT	CS-30TAC	CS-40TAC
Temperature range	0 °C to 1000 °C		-40 °C to 500 °C	
Area size	φ 30/500 mm 22:1	φ 40/500 mm 15:1	φ 30/500 mm 22:1	φ 40/500 mm 15:1
Optics	Silicon lens(Water-repellent coat, Oil-repellent coat)			
Detection element / Wavelength	Thermopile/ 8 to 14 μm			
Response speed	150 msec/90 %			
Accuracy	0 to 200 °C: ± 2 °C 201 to 1000 °C: Reading value ± 1 %		-40 to 0 °C: ± 3 °C 1 to 200 °C: ± 2 °C 201 to 500 °C: Reading value ± 1 %	
Repeatability	Up to 200 °C: ± 1.0 °C 201 °C and more : ± 0.5 %			
Emissivity rate adjustment	0.1 to 1.2			
Power supply	12 to 24 VDC ± 10 %			
Consumption	120 mA (Max. load), 80 mA (Eco mode)			
Ambient temperature	Sensor head: 0 to 180°C, Amplifier: 0 to 65°C		Sensor head: 0 to 100°C, Amplifier: 0 to 65°C	
Ambient humidity	35 to 85 % (without condensation)			
Storage temperature	0 to 70 °C			
Water resistance	Sensor head: IP69K, Amplifier: IP40			
Vibration resistance	10 to 55 Hz, 1.5 mm amplitude, 2 hours each for XYZ directions			
Material	Sensor head: SUS, Amplifier: ABS			
Dimensions	Sensor head: M12 ( φ 14) x 34 mm, Amplifier: 35 x 52 x 38.5 mm			
Weight	Sensor head: Approx. 100 g (including a cable of 3 m), Amplifier: Approx. 200 g (including a cable of 2 m)			
Display	LED			
Resolution	1°C			
Analog output	4 to 20 mA			
Analog output resolution	0.5°C			
Analog output accuracy	± 0.5% or ± 1.0°C			
Analog output updating time	10msec			
Analog output allowable load	250 Ω			
Analog output impedance	47 Ω			
Contact output	Photo MOS FET x 2 (c contact x 2)			
Contact output capacity	300 mA/ 30 VDC or less			
Interface	Digital output			
Others	Trigger (synchronous) input			
	Bank switch x 4			

Accessories: Mounting nut (M12 × P1.0) × 2

Options: Black body tape, mounting fitting, amplifier protective case, changeable laser marker, air purge collar, CF lens

\* The specifications are subject to change without notice for product improvement.

# External Dimensions/Parts Name

## ● Sensor head

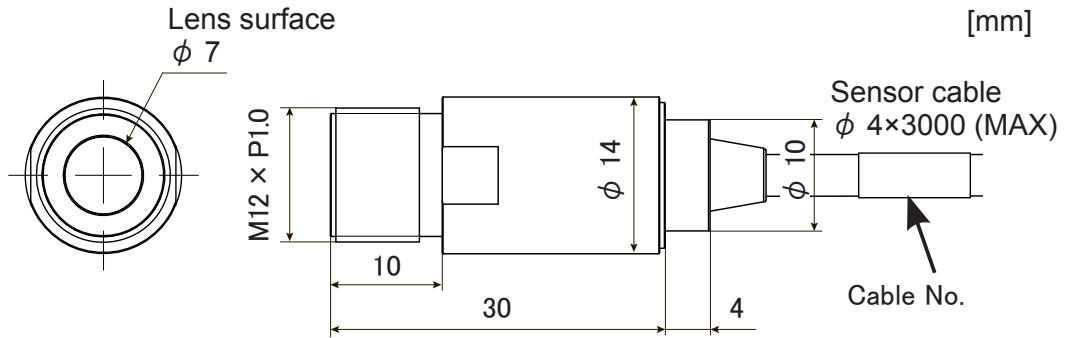

## ● Amplifier

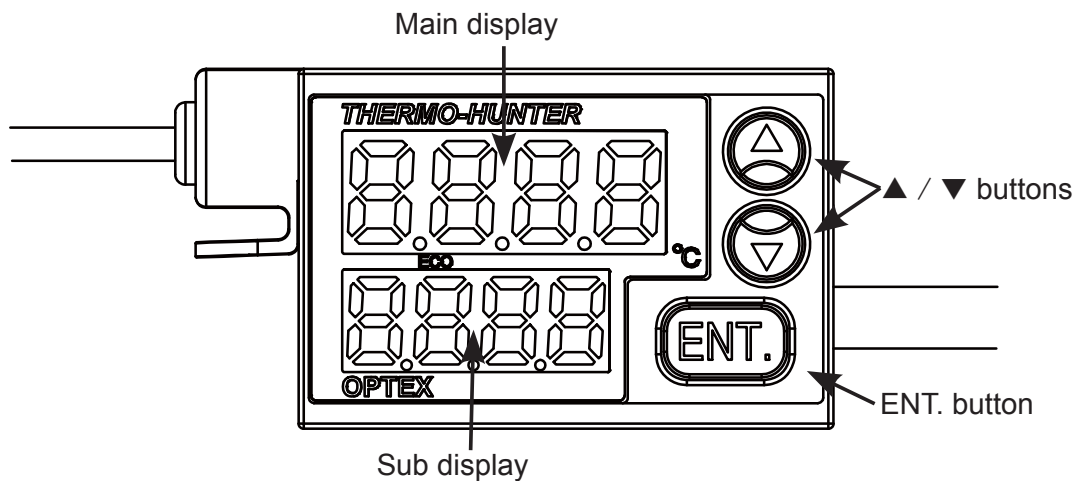
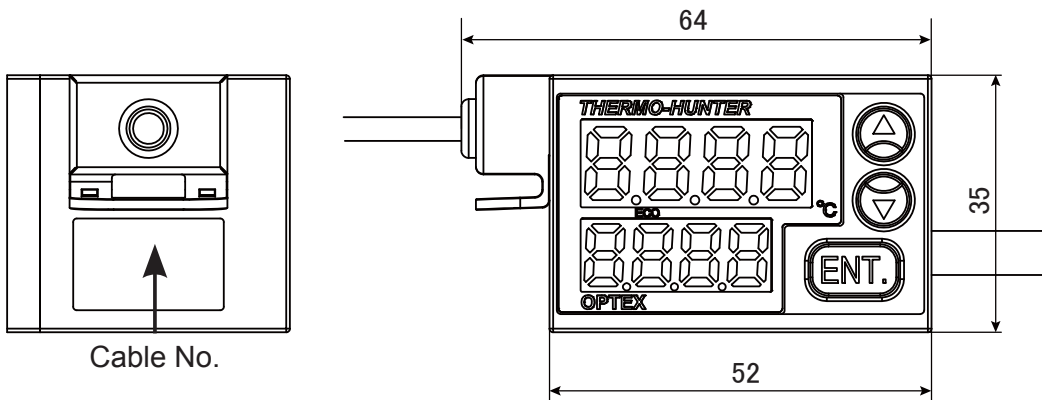
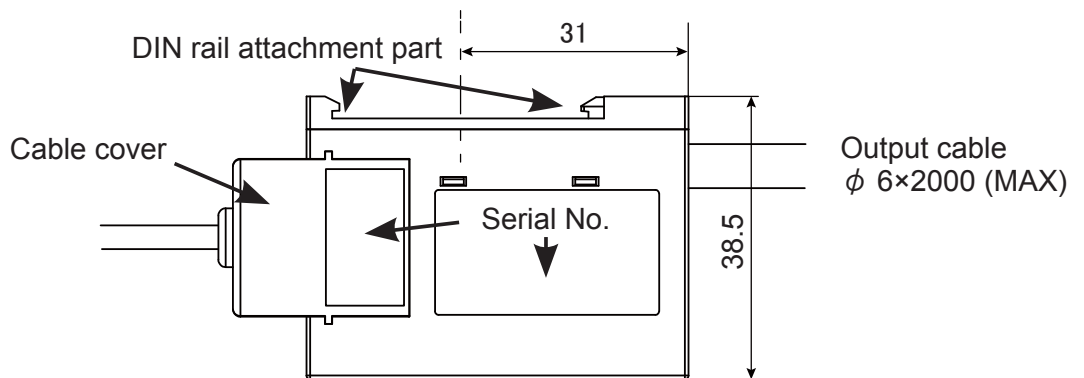

# Wiring Diagram

## ●Output cable

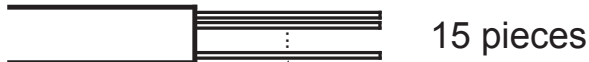

15 pieces



Dot mark 1



Dot mark 2

No.	Output cable			Descriptions	
	Line color	Dot mark			
		Color	Quantity		
1	Pink	Red	1	Power supply	12 to 24 VDC
2	Gray	Black	1		GND
3	White	Red	1	Analog output 4-20 mA	+
4	White	Black	1		-
5	Pink	Black	1	External trigger	Input
6	Gray	Black	2	Bank switch	(1)
7	White	Red	2		(2)
8	Yellow	Red	1	Alarm output H	N.C.
9	Gray	Red	1		COM
10	Yellow	Black	1		N.O.
11	Orange	Red	1	Alarm output L	N.O.
12	Gray	Red	2		COM
13	Orange	Black	1		N.C.
14	Orange	Red	2	Digital output	Output
15	Orange	Black	2		Input
16	*4 (Shielded cable)			-	

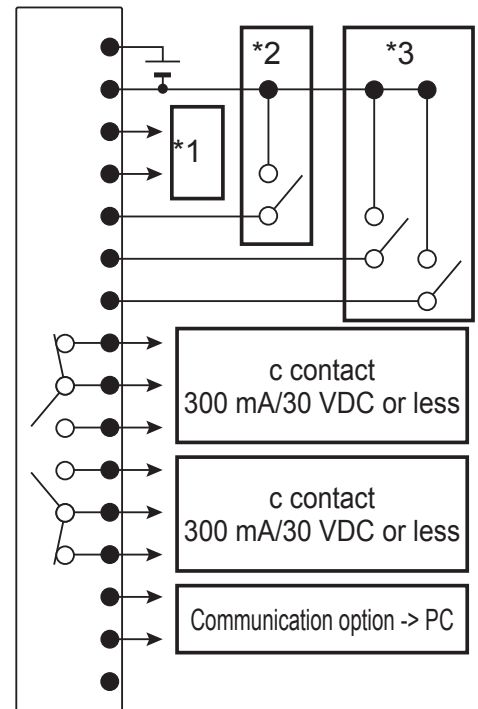

\*1 Connect to the 4-20 mA input of an analog device.

Analog output allowable load 250Ω and analog output impedance 47 Ω

\*2 External trigger: Switches on/off in the range from 2 to 5.

\*3 Bank switch: Switches OPEN/CLOSE in the range from 2 to 6 or from 2 to 7 to select a bank.

BANK	(1)	(2)
1	OPEN	OPEN
2	CLOSE	OPEN
3	OPEN	CLOSE
4	CLOSE	CLOSE

\*4 When you cut the output cables shorter, a shielded cable for reinforcement will come out. Cut the shielded cable to prevent it from contacting with other cables.

\* Cables not used should be cut so that they do not contact with other cables, and insulated with adhesive tape or by other methods.

● Sensor cable

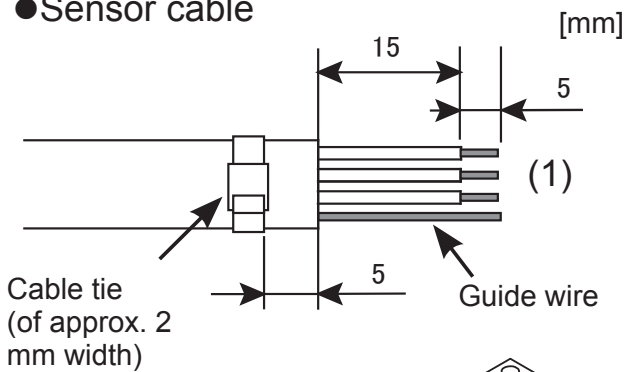

When you cut the sensor cables, ensure to perform end treatment and connection of the cables.

(1) Cut the cables to a desired length and treat their end as shown in the left figure.  
A guide wire is sheathed in the shielded mesh cable. Cut the other cables than the guide wire at their base.

(2) Pass the sensor cable bundle through the hole of the cable cover and tighten the cable tie at the point shown in the left figure.

\* The serial numbers are printed on the cable cover. Make sure to put each sensor cables back to the same holes that you removed.

(3) Connect the cables and shielded cable (guide wire) to the connector.

(4) Insert the connector to the cable cover.

\*The metal plate of connector should be placed onto the clasp in the cable cover.

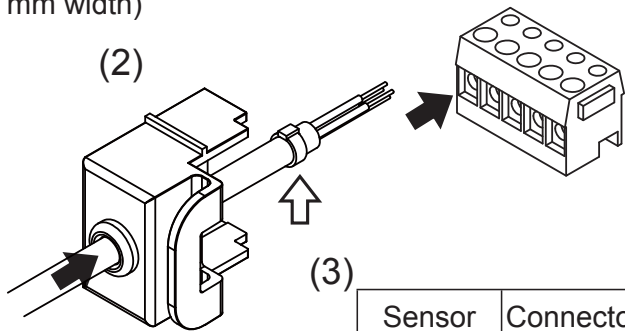

Sensor cable	Connector No.
Green	1
Yellow	2
Brown	3
Shield	4
—	5

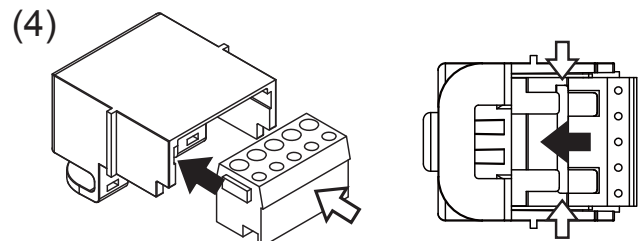

○ Connecting the sensor cables  
Keeping the connector pushed in, fit the cable cover to the grooves of the amplifier, and insert the cable cover.

○ Removing the sensor cables  
Pinch the tab of the cable cover and pull the cable cover upward.

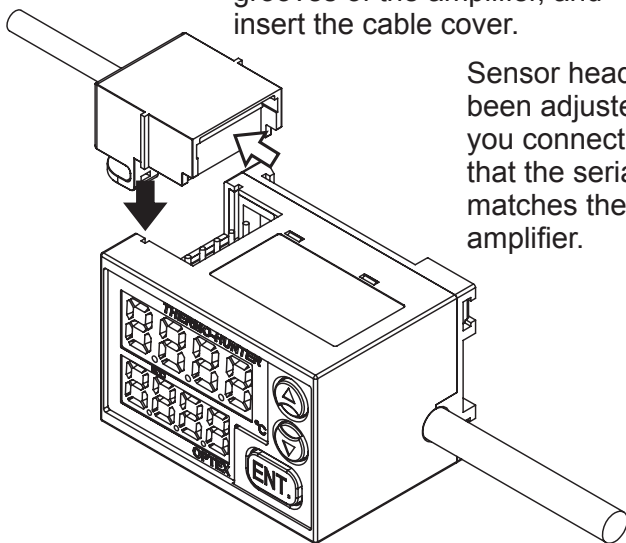

Sensor head and amplifier has been adjusted in one set. When you connect both, make sure that the serial number of cable matches the serial number of amplifier.

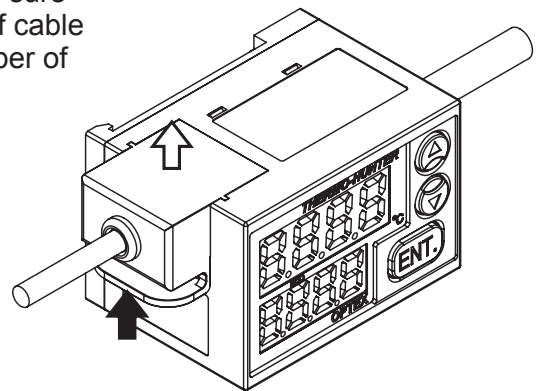

Amplifier is not a protective structure. When you connect the output cable and the sensor cable, make sure that the water or oil does not penetrate to amplifier along the cable. When used in such an environment where water or oil might get in to the amplifier, please use optional protective case. (Equivalent to IP65)

Please noted that continuous hot water with high pressure may cause breakage of the cable or covering.

# Mounting/Installation

## ●Sensor head

The external screw is M12 × P1.0.

Fix securely into the hole of  $\phi$  12 mm or more using the attached hexagon nut.

The optional mounting fitting can help you adjust the angle easily.

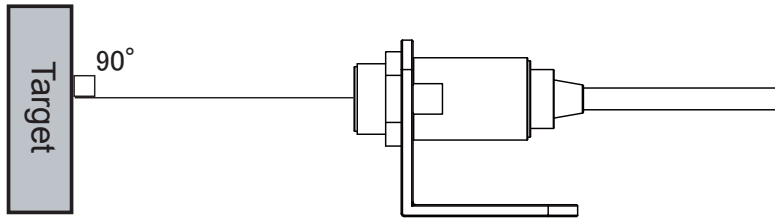
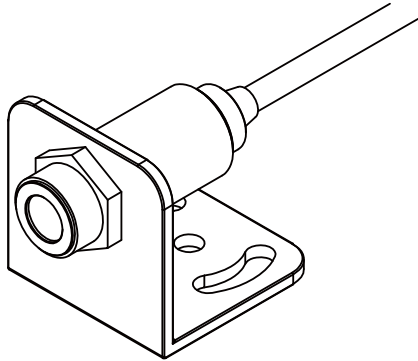

### ○ Mounting

Mount the sensor head perpendicular to the target.

Avoid a location where the sensor head may be exposed to vibration or impact.

The ambient temperature should not rapidly change and should be within the operating temperature range.

Do not fix the cable when it is bent or excessive load is applied to it.

Although the sensor head is water-resistant, water drops on the lens may cause an error.

## ●Amplifier

Mount the amplifier on the DIN rail using the hooks on its bottom.

Avoid a location where water or oil may spill on it.

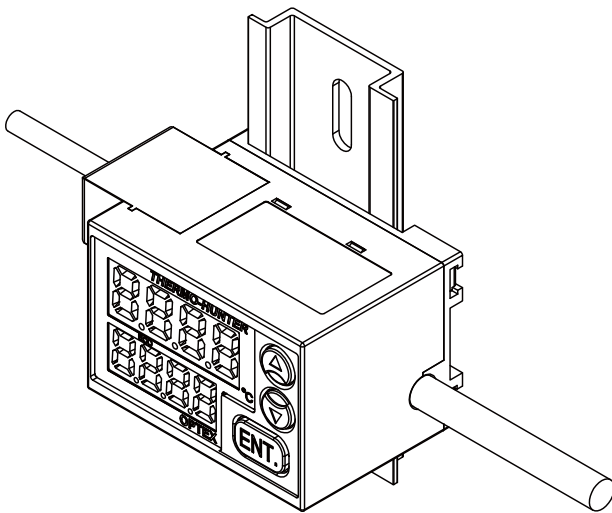

### ○ Mounting

Make the two hooks on the SW side catch the DIN rail and push in to set the amplifier.

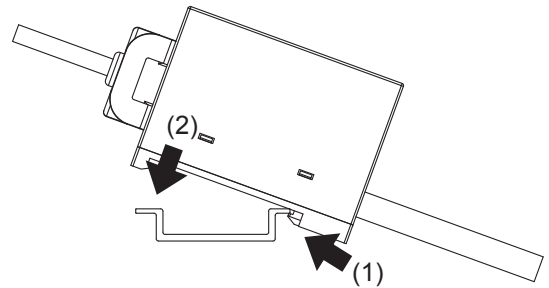

### ○ Removing

Push the two hooks on the SW side to the opposite direction and raise the amplifier.

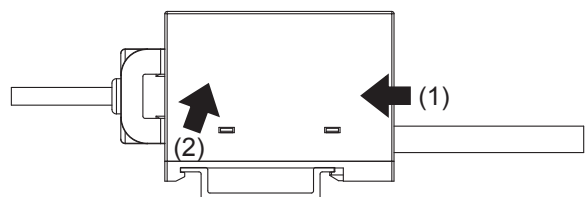



# Field of View

[CS-30TAC/CS-30TAC-HT]

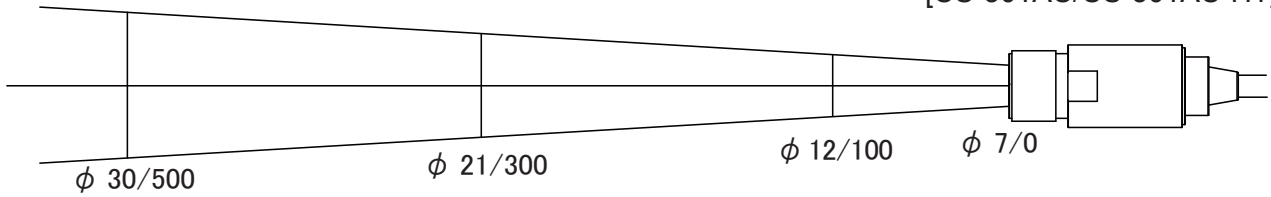

D (distance) : S (area) = 22:1

[CS-40TAC/CS-40TAC-HT]

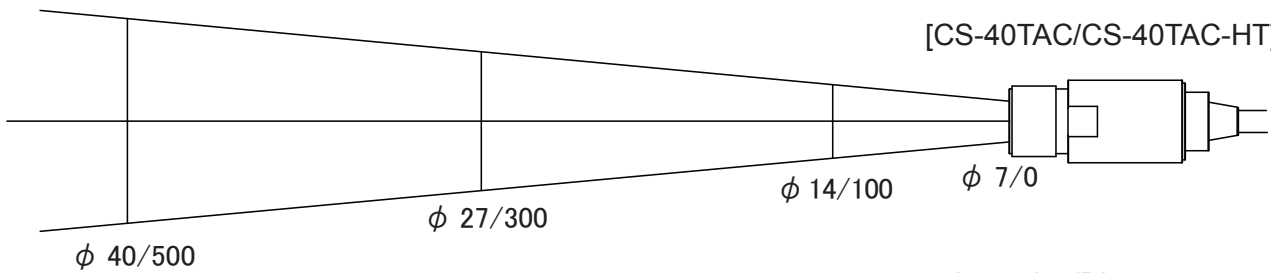

D:S = 15:1

Area size/Distance

[mm]

[For correct measurement]

The range of field of view is equivalent to 90% of optical response (energy).

The target measured should be sufficiently larger than the field of view shown above.

When measuring a high-temperature target, keep as much distance from it as possible within the range of the field of view.

If the main body rapidly heats up, a measurement error may occur.

● When using the optional CF lens

[CS-30TAC/CS-30TAC-HT + CF]

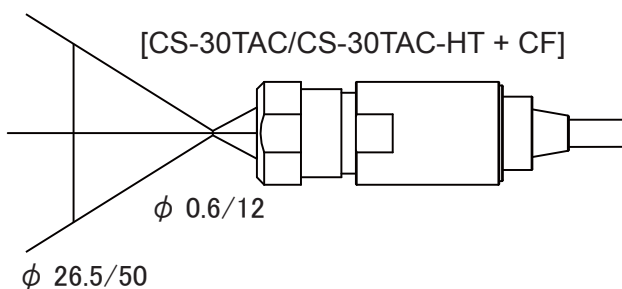

[CS-40TAC/CS-40TAC-HT + CF]

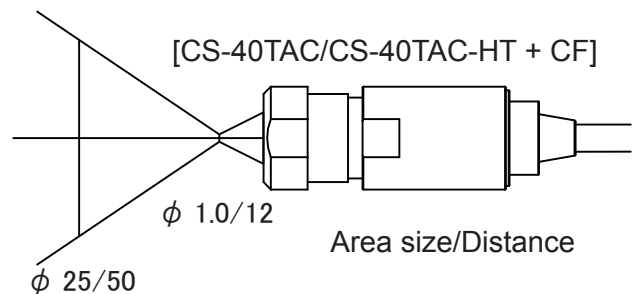

Area size/Distance

[mm]

\* When the CF lens is attached, correction is necessary because light intensity received from the target decreases by 20 to 30%.

When measuring a minute spot, the recommended target size is approximately 1.5 times of the field of view shown above.

# How to Use

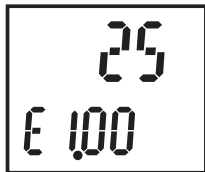
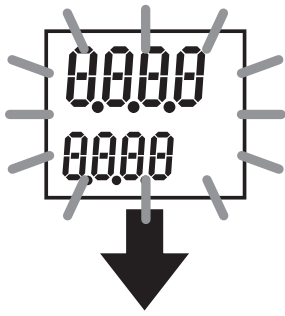

Normal measurement

- (1) Check that the connections are correct and turn the power on.  
The display flashes and temperature measurement starts.
- (2) Check that the unit performs normal operation.  
Put your hand over the head part to check that the measurement value changes.

\* A measurement error may occur just after the sensor head is mounted.



Press 3 sec. or more

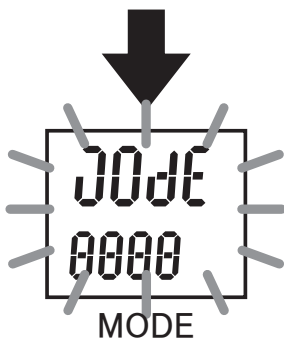

MODE indication flashes and the unit enters the setting mode.

- (3) To check the Setting values, switch the setting modes.
- (4) Press the ENTER Button for three seconds or more to switch the setting mode.  
The unit enters the setting mode when the BANK indication appears after the MODE indication flashes.
- (5) Select the item with ▲/▼ buttons to check the setting.

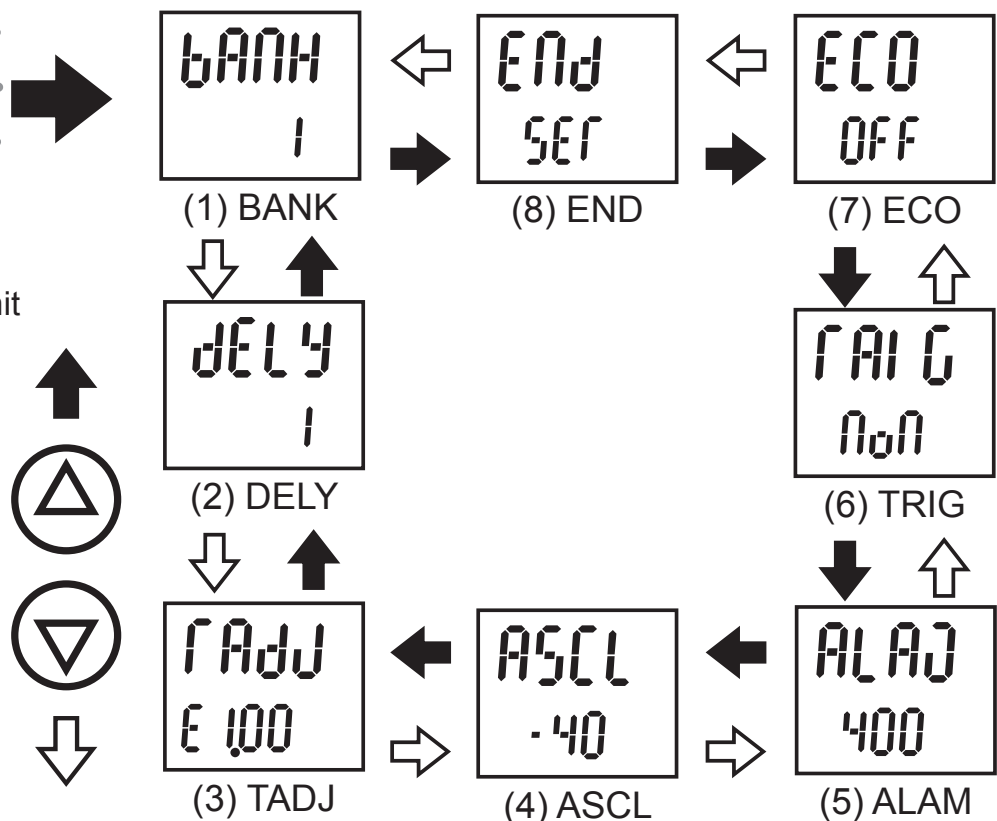

\* The indications above are factory setting.  
The sub indication values of ASCL and ALAM are different depending on the model.

# Function List

To change the settings, press the ENTER button for three seconds or more.

The settable items are shown below.

Change the settings as necessary.

While the indication flashes, the settings are being read or written and the button operation is not accepted.

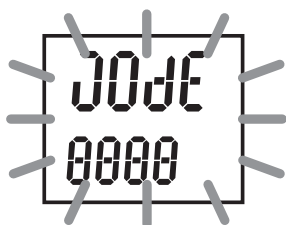

Flashing / Button operation is not possible

Lighting / Button operation is possible

If the unit is left unoperated for ten seconds or more, it returns to the measurement mode. At the time, the settings not saved by END -> SET will be deleted.

No.	Indication	Name	Descriptions	Page
(1)	bANK	Bank	Select the bank (1 to 4) to change the setting.	12
		Individual setting is possible for each of 1 to 4 banks. Switching the bank by cable connection can call up the saved setting.		
(2)	dELY	Delay	Select the response time.	12
		The response time changes as you change the number of moving average times. The response time is delayed more as you increase the number, which is effective to minimize fluctuation of measurement values.		
(3)	rADJ	T-Adjust	Make the temperature measurement settings such as emissivity rate.	12
		You can change the emissivity rate and make simple temperature adjustment.		
(4)	ASCL	Analog Scale	Change the output temperature width of analog output.	15
		You can specify a desired measurement width for analog output (4-20mA) within the measurement temperature range.		
(5)	ALAD	Alarm	Make the contact output settings.	16
		You can select ON/OFF, type and temperature for alarm output.		
(6)	rALG	Trigger	Make the trigger input settings.	18
		You can specify the type of trigger input as a switch to execute output control.		
(7)	ECO	ECO	Set the ECO mode.	21
		You can set the ECO mode in order to reduce current consumption by turning off the display of main unit.		
(8)	END	End	Save the modified settings.	21
		You can save the Setting values in the bank or switch to the next bank to change the setting. * The values confirmed with SET will be deleted if they are not saved in this mode.		

# Setup of Functions

## ● **bANK** : BANK/ Bank mode



Select the bank No. to make the setting.

There are four banks (1 to 4) in total, each of which can have its own setting.

The No. displayed first is that of the bank enabled in normal operation.

\* The bank enabled in normal operation should be selected by connecting the cable.

You cannot select it in the setting mode.

(1) Enter the BANK mode select the bank No.

(2) Press the ENTER button to confirm the setting.

\* Switch banks in END mode, when changing the setting value for each bank in succession.

\* The changed values for setting become effective by saving them in END mode(SET).

## ● **dELY** : DELY/ Delay mode



Select the response time.

You can select the value between 1 and 200 of the number of moving average times. Selecting a larger value will delay the response time more.

1 = response time of the product (0.15 sec.) to 200 = approximately 10 sec.

This setting can average (smooth) fluctuation of measurement values and large variation of temperature.

(1) Enter the DELY mode select the value.

(2) Press the ENTER button to confirm the setting.

## ● **rAdj** : TADJ/ Thermo Adjust mode



Make the temperature measurement settings.

TECH: Input the temperature value of the target to automatically calculate the emissivity rate.

$\epsilon$ : Input the emissivity rate directly.

AADJ: The display value can be adjusted in accordance with the specified value (within the measurement temperature range).

NON: Cancel the TADJ mode. The unit returns to the function selection mode.

Indications of selectable settings



TECH



$\epsilon$



AADJ



NON

\* Setting NON with SET returns the unit to the state of before making the setting.

○ **TECH** : TECH/ Teach mode

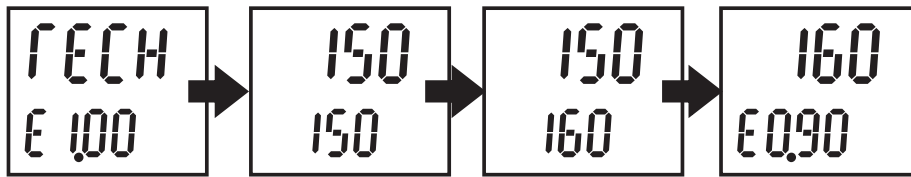

- (1) Press the ENTER button in the Teach mode after confirming the target is aimed sufficiently larger than the field of view.
- (2) When the current measurement value is displayed, input the temperature of the target.
- (3) Press the ENTER button to confirm the setting.
- (4) Check that the indicated value and emissivity rate have been changed.

● Error indication

An error is displayed when the set item or input value is incorrect. Perform the procedures below when an error is displayed.

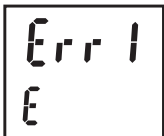

In the TECH mode, if the automatically calculated emissivity rate is outside the setting range (0.1 to 1.2), an error (Err1) occurs. In this case, the emissivity rate cannot be set in the TECH mode. Set it in the ε mode again.

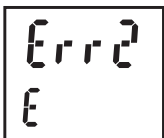

In the TECH mode, if the temperature measurement value calculated with the automatically calculated emissivity rate is outside the measurement temperature range, an error (Err2) occurs. In this case, the emissivity rate cannot be set in the TECH mode. Set it in the ε mode again.

○ **ε** : ε/ Emissivity mode



- (1) In the ε mode, press the ENTER button to make the setting.
- (2) Directly input the emissivity rate.
- (3) Check that the indicated value and emissivity rate have been changed.

**Emissivity rate (ε)**

The emissivity rate is the rate of energy emitted from the surface of an object. Every object has a unique emissivity rate which is variable according to the surface condition and temperature of the object. This product allows for setting a desired emissivity rate, which can enable even more precise measurement by adjusting the emissivity rate according to that of the target. An object with low emissivity rate (e.g. a shiny metallic object) reflects the surrounding temperature since it is highly reflective. If the surrounding objects have greatly different temperature from that of the main unit, their temperatures are reflected resulting in incorrect measurement. Therefore it is necessary to block out such effect. The maximum emissivity rate is normally 1.00, but this unit is designed to accept up to 1.20 for practical convenience.

# Setup of Functions

## ○ AADJ : AADJ/ Analog Adjust mode



This setting is for adjusting the measurement value with the specified value according to the measuring targets. A intended value can be output by setting L (lower limit value) and H (upper limit value) conforming to the both specified value.

\* Measurement accuracy can not be guaranteed for the value made by AADJ mode.

\* Please do not change emissivity after setting in the AADJ mode, otherwise the adjusted value will be changed.

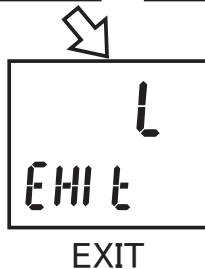
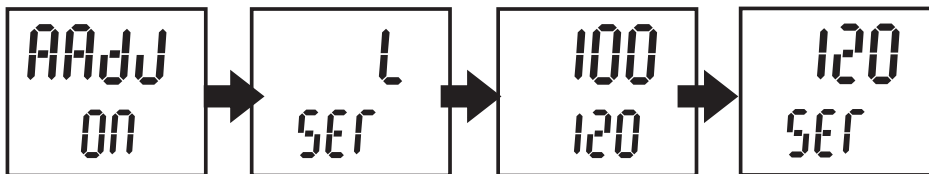

- (1) Set the AADJ mode to ON and press the ENTER button to make the setting.
  - (2) Press the ENTER button after confirming the target is aimed sufficiently larger than the field of view.
  - (3) Check that the target is in the measurement area. The current measurement value appears on the display. Press the ▲/▼ buttons to input the temperature L (lower limit value) of the target.
  - (4) Press the ENTER button to confirm the setting.
  - (5) Check that the indicated value has been changed.
- \* To input the value later, select EXIT.

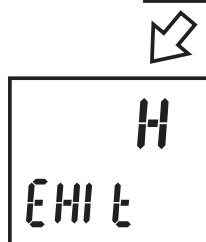
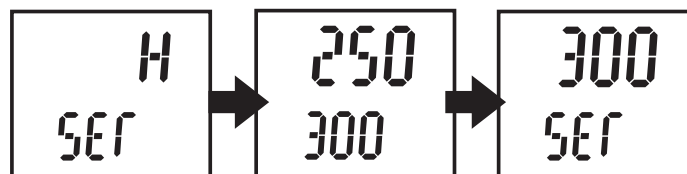

- (1) Set the AADJ mode to ON and press the ENTER button to make the setting.
  - (2) Press the ENTER button after confirming the target is aimed sufficiently larger than the field of view.
  - (3) Check that the target is in the measurement area. The current measurement value appears on the display. Press the ▲/▼ buttons to input the temperature H (upper limit value) of the target.
  - (4) Press the ENTER button to confirm the setting.
  - (5) Check that the indicated value has been changed.
- \* To input the value later, select EXIT.

\* If the timings to set L and H are different (e.g., when using the same target for setting L and H), set either of them first and save the setting with END. Otherwise the input value will be canceled.



The adjusted value are effective after the both of L and H value are set and stored. When AADJ mode on, AADJ is displayed as sub indication. The measuring value is output according to the setting value previously stored, if the setting of L and H value are stored in EXIT mode with AADJ mode on. In this process, AADJ is also displayed as sub indication.

\* Either the upper or the lower limit value can not be changed after the setting is completed.

\* The minimum temperature width for upper limit value and lower limit value is 10 degree.

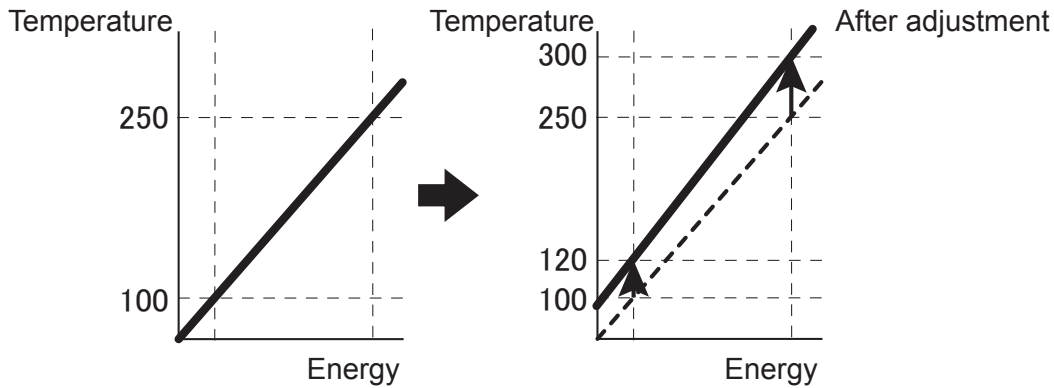

● **ASCL** : ASCL/ Analog Scale mode

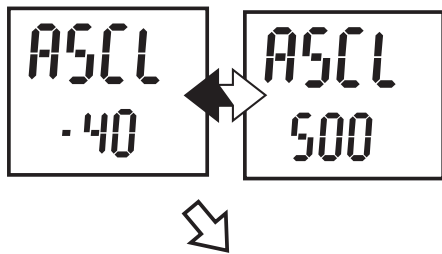

You can change the temperature range of analog output (4 - 20 mA) within the measurement temperature range.

H (upper limit value): Value for 20 mA output

L (lower limit value): Value for 4 mA output

\* The value of sub indication displayed first is the current Setting value.

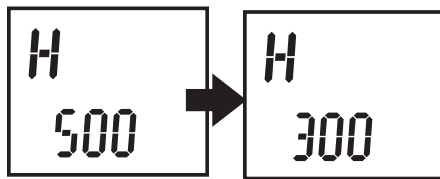

(1) In the ASCL mode, press the ENTER button to make the setting.

(2) H (upper limit value) is displayed.

Change the value and press the ENTER button to confirm the setting.

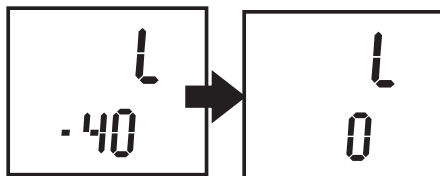

(3) L (lower limit value) is displayed.

Change the value and press the ENTER button to confirm the setting.

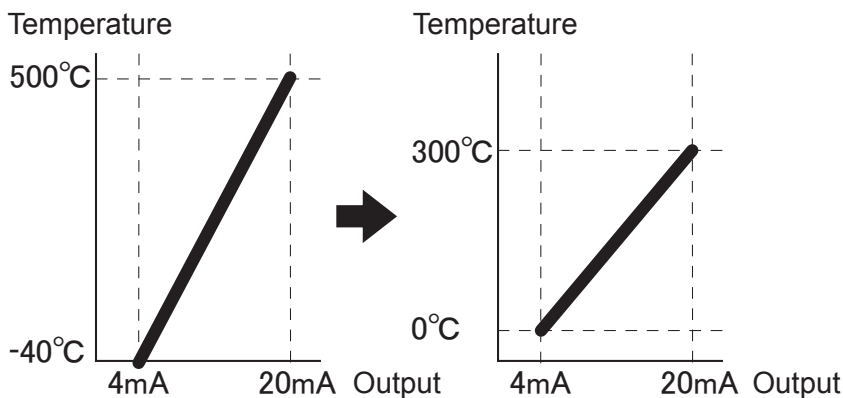

\* The minimum width of output range is 100°C. You cannot set it to less than 100 °C.

0 to 1000 °C: 4 – 20 mA → 100 to 200 °C: 4 – 20 mA ○

→ 100 to 180 °C: 4 – 20 mA ×

# Setup of Functions

## ● ALAD : ALAM/ Alarm (contact) output mode

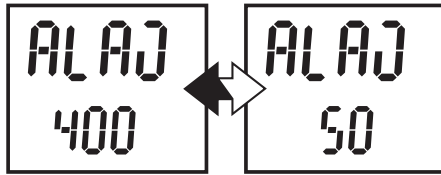

You can set the temperature and output method of alarm (contact) output.  
 H (upper limit value): Output turns on when the value exceeds the Setting value.  
 L (lower limit value): Output turns on when the value falls below the Setting value.  
 Select one of the three types of OUT (output) mode: NOR, DEL and ONES.



NOR

NOR: Output is kept on as long as the value is over or below the set temperature.

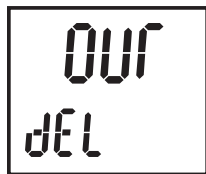
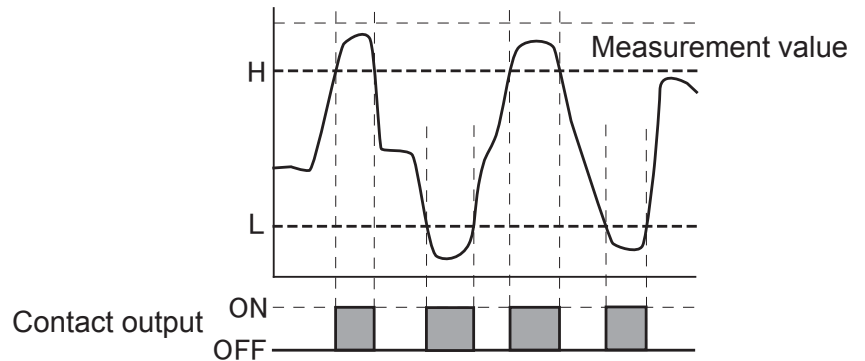

DEL

DEL: Output turns on when a specific time period passes after the value exceeds or falls below the set temperature.

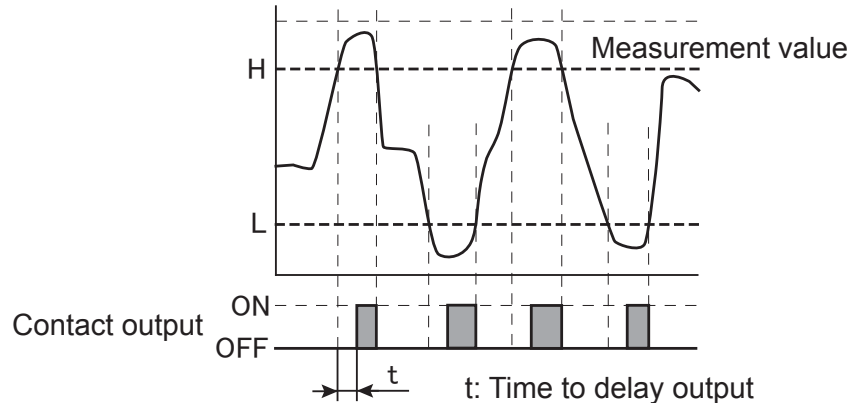

ONES

ONES: Output turns on when the value exceeds or falls below the set temperature and is kept for a specific time.

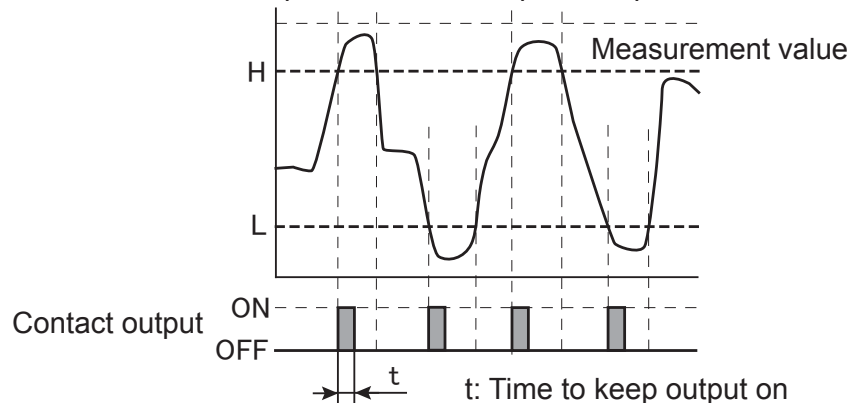





- (1) Switch from OFF to ON and press the ENTER button to confirm the setting.
  - (2) When the upper limit value is displayed, press the ▲/▼ buttons to input the temperature.
  - (3) Press the ENTER button to confirm the setting.
- \* To cancel the setting, select OFF and press the ENTER button.



- (1) Switch from OFF to ON and press the ENTER button to confirm the setting.
  - (2) When the lower limit value is displayed, press the ▲/▼ buttons to input the temperature.
  - (3) Press the ENTER button to confirm the setting.
- \* To cancel the setting, select OFF and press the ENTER button.

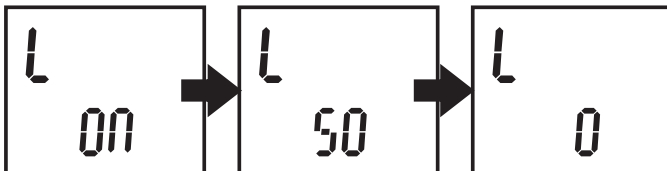

## ○ *OUR* : OUT/ Output mode



Select the output mode.  
To set to the NOR mode, press the ENTER button to confirm the setting.  
To set to the DEL mode,

- (1) Switch to the DEL mode and press the ENTER button to confirm the setting.
- (2) When the time to delay output (TIME) is displayed, press the ▲/▼ buttons to input the time. The settable range is between 0.01 to 2.00 seconds.
- (3) Press the ENTER button to confirm the setting.

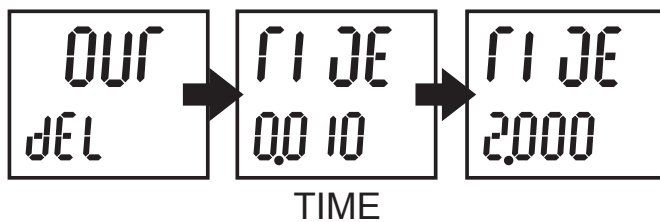

- To set to the ONES mode,
- (1) Switch to the ONES mode and press the ENTER button to confirm the setting.
  - (2) When the time to keep output (TIME) is displayed, press the ▲/▼ buttons to input the time. The settable range is between 0.01 to 2.00 seconds.
  - (3) Press the ENTER button to confirm the setting.



# Setup of Functions

## ● TRIG : TRIG/ Trigger (synchronous) input mode



You can select the output control at the time of trigger (synchronous) input.

NONE: No setting

EXT: External trigger input

WAVE: WAVE trigger input

\* Output is controlled by setting the specified temperature as the judgment criterion value (WAVE LIMIT).

Output setting

MAX: The maximum value between the synchronous input points is output.

MIN: The minimum value between the synchronous input points is output.

P-P: The difference between the maximum and minimum values between the synchronous input points is output. (For EXT only)

SAMP: The value at the moment of synchronous input is output. (For EXT only)



NON



EXT



WAVE



MAX



MIN



P-P



SAMP

### MAX HOLD

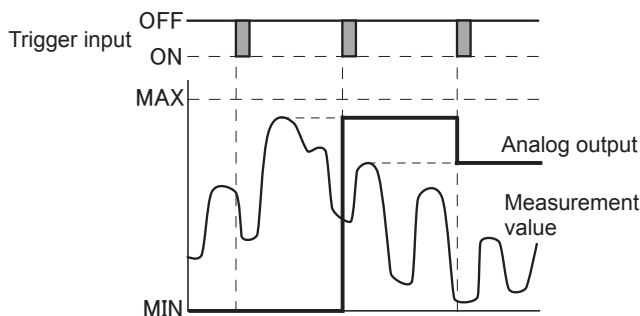

### MIN HOLD

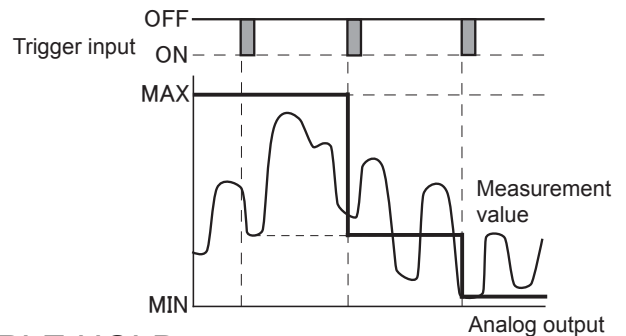

### P-P HOLD

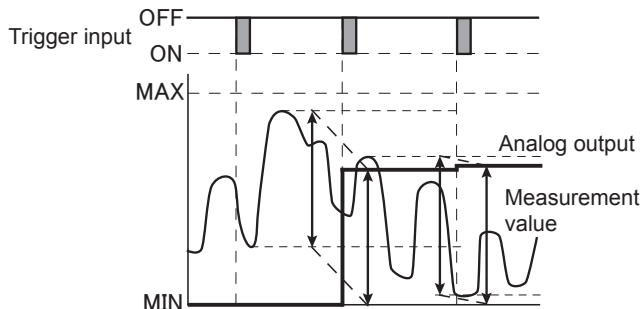

### SAMPLE HOLD

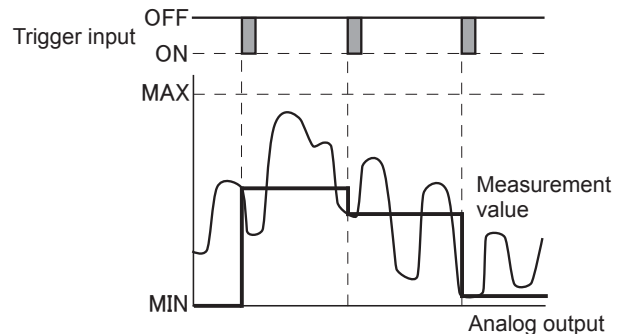

○ **EXT** : EXT/ External Trigger mode



- (1) In the TRIG mode, select EXT and press the ENTER button to confirm the setting.
- (2) Select the analog output at the time of trigger input.
- (3) Press the ENTER button to confirm the setting.

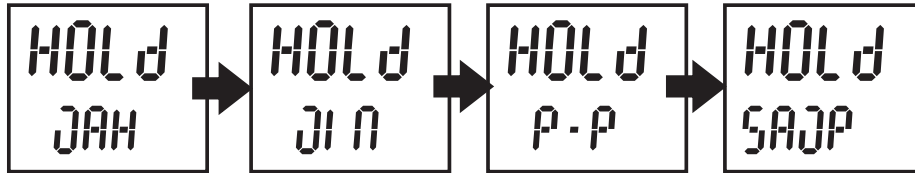

○ **WAVE** : WAVE/ Wave Trigger mode



- (1) In the TRIG mode, select WAVE and press the ENTER button to confirm the setting.
  - (2) Select the analog output at the time of WAVE trigger input.
  - (3) Input the WLIT/WAVE LIMIT value.
  - (4) Press the ENTER button to confirm the setting.
- \* In the WAVE mode, the selectable output setting is MAX or MIN only.

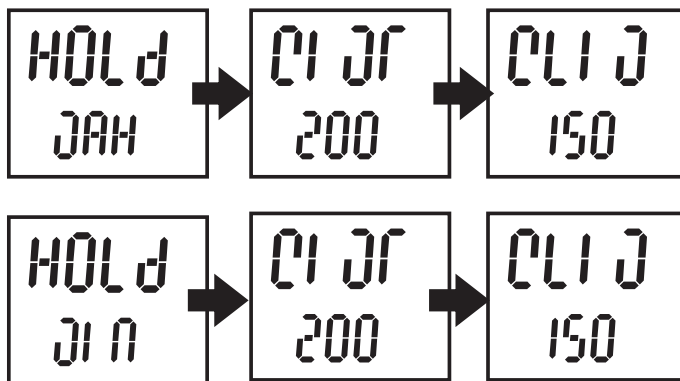

WAVE MAX HOLD

WAVE MIN HOLD

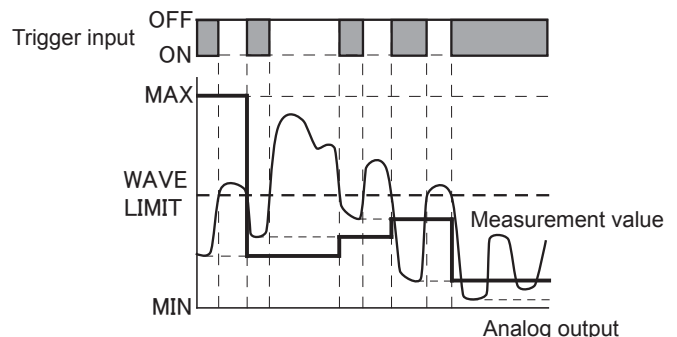
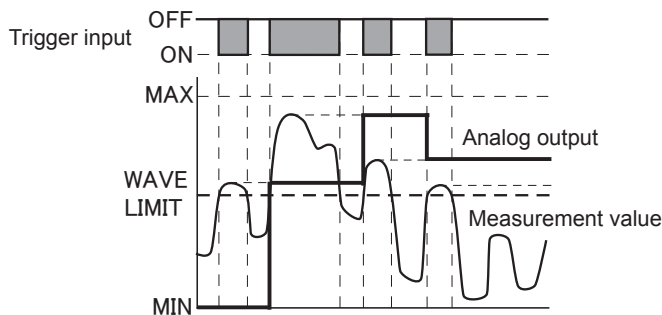

\* After the power is turned on and before the first trigger is input, the minimum value (4 mA) is output in the MAX, P-P and SAMPLE settings and the maximum value (20 mA) in the MIN setting. Sampling starts at the first trigger input, and the analog output control starts from the second trigger input.

\* If the alarm output has been set, the judgment criterion will be the analog output controlled by the trigger input setting. -> Page 20

# Setup of Functions

## ● Combination of alarm output and trigger input

This unit allows individual setting for each function.

The behavior when the alarm output and trigger input are combined is as described below. The alarm output uses the analog output value as the judgment criterion, so when the trigger input is set, the controlled analog output will be the judgment criterion.

Setting value

Alarm: H/L setting      NOR output  
Trigger: External trigger      MAX HOLD

According to the analog output of MAX HOLD set by the trigger input, alarm is output while the value is outside the range between H and L.

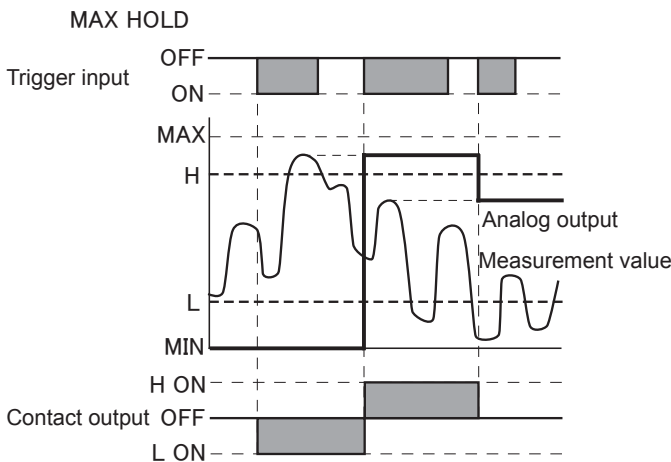

Setting value

Alarm: (1) H/L setting      NOR output  
          (2) H/L setting      DEL output  
          (3) H/L setting      ONES output  
Trigger: WAVE trigger      MAX HOLD

According to the analog output of MAX HOLD set by the trigger input, alarm is output while the value is outside the range between H and L.

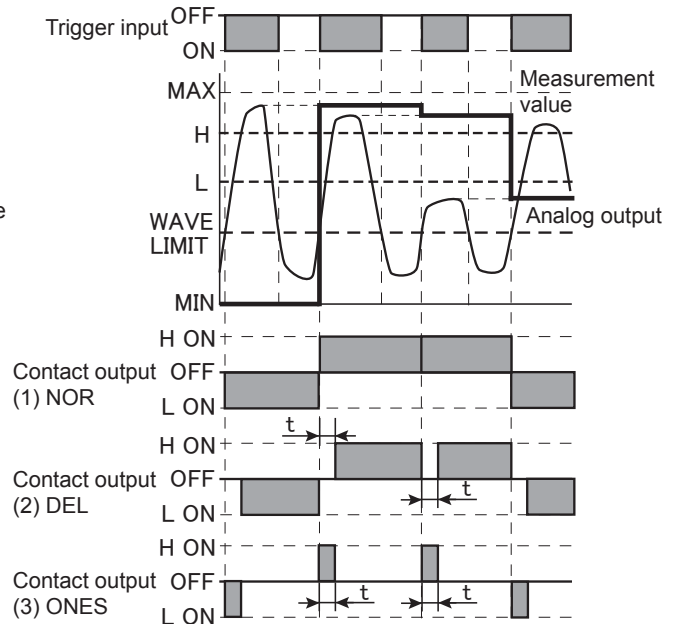

## ● ECO : ECO mode



You can reduce consumption current by turning off the display during normal measurement.

- (1) Enter the ECO mode and select ON.
- (2) Press the ENTER button to confirm the setting.
- (3) Input the time that elapses before the display is turned off.  
The settable range is between 1 to 600 seconds.
- (4) Press the ENTER button to confirm the setting.

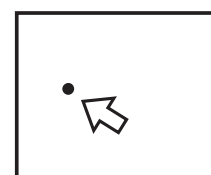

When ECO is ON  
A single dot is lighting.

● **END** : END mode



You can save (SET) or cancel (CSEL) the setting and change the bank No. to make the setting.

\* The Setting values become valid only after they are saved. The setting is restored to its previous state if the unit returns to the measurement mode without saving them or the Setting values are canceled.

- (1) Enter the END mode and select SET (save) or CSEL (cancel).
- (2) Press the ENTER button to confirm the setting.
- (3) The unit returns to the normal measurement mode.

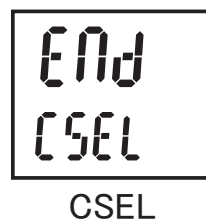

To switch the bank to make the setting

- (1) Enter the END mode and select the number from 1 to 4.
- (2) The unit enters the setting mode for the selected bank. Make the necessary setting.

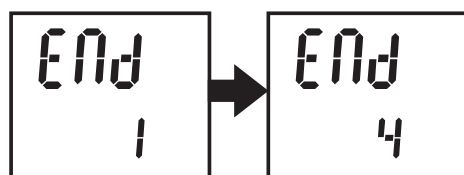

[Note of the setting]

BANK						
DELY						
$\epsilon$						
AADJ	L =	$^{\circ}\text{C} \rightarrow$	$^{\circ}\text{C}$	H =	$^{\circ}\text{C} \rightarrow$	$^{\circ}\text{C}$
ASCL	L(4mA) =	$^{\circ}\text{C}$	H(20mA) =	$^{\circ}\text{C}$		
ALAM	L =	$^{\circ}\text{C}$	H =	$^{\circ}\text{C}$		
	NOR	DEL	ONES			
		TIME	ms			
TRIG	EXR					
		MAX	MIN	P-P	SAMP	
	WAVE	MAX	MIN			
		WLIT : WAVE LIMIT	$^{\circ}\text{C}$			
ECO	ON	OFF				
	TIME	ms				

## Troubleshooting

Problem	Cause	Action
Cannot measure.	The power is not applied.	Check the cabling and connections.
	The power voltage is low.	Check the power voltage and adjust it to the 12 to 24 VDC range.
The measurement value is wrong.	The lens is dirty.	Clean the lens referring to the Lens section under "Maintenance".
	The measurement area is off center.	Adjust the mounting position so that the target comes to the center of the area.
	A high-temperature object is near the target affecting the measurement.	Block the heat source using a board, etc.
	The emissivity rate setting is not correct.	Set the emissivity rate to that of the target.
The measurement value is not stable.	The sensor head is affected by vibration.	Prevent vibration.
	The sensor head is affected by rapid temperature change.	Leave the sensor head for a while until the temperature becomes stable.

\* If the problem persists even after taking the actions above or the problem is not listed here, contact the sales distributor.

## Maintenance

Lens	Dust, dirt and scratches on the lens can cause incorrect measurement. If the lens is dirty, remove the dust using a blower for cleaning lens. For stubborn dirt, apply a small amount of ethyl alcohol to a cotton swab or special lens cleaning cloth and gently wipe off the dirt.
Amplifier	For heavy dirt on the amplifier, use a lightly moistened cloth to wipe it off. Do not use alcohol or such other material because it may damage the surface or fade the printing.
Calibration	Yearly calibration is recommended. The sensor head and amplifier cannot be separately calibrated. Always calibrate them together. For details, contact the sales distributor.

You can rinse the sensor head with water because it is water-resistant. However, water drops remaining on the lens will cause incorrect measurement. Be sure to wipe them off with a soft cloth or blow them off with air.

You can easily remove water or oil by using air as the water/oil-repellent coat is applied on the surface of lens.

If the unit may be exposed to splash of water or oil or located in a dusty place during measurement, use the optional air purge collar.