

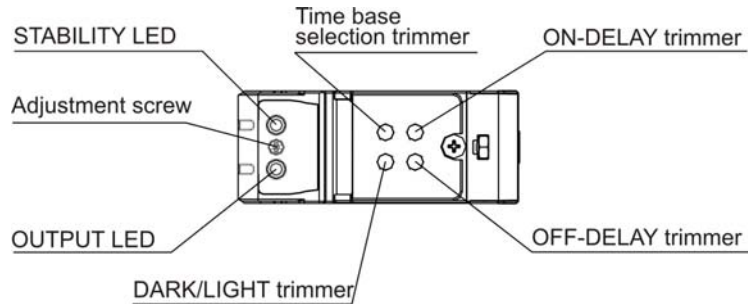

INSTRUCTION MANUAL

CONTROLS



OUTPUT LED (yellow)
The yellow LED ON indicates the output status.

STABILITY LED (green)
The green LED ON indicates that the sensor has working with a enough safety margin.

ADJUSTMENT TRIMMER (ADJ.)
The multiturn trimmer with clutch adjusts the suppression distance through the mechanical variation of the optic triangulation angle. Please refer to "SETTING" paragraph for procedure indications.

DARK/LIGHT TRIMMER
A mono-turn trimmer to select dark/light mode.

ON-DELAY AND OFF-DELAY TRIMMER (only versions with timing functions)
Mono-turn trimmers to setting output activation and disactivation delay time. Please refer to "TIMING FUNCTIONS" paragraph for procedure indications.

TIME BASE SELECTION AND ONE-SHOT TRIMMER (only versions with timing functions)
A mono-turn trimmer with three operation position: it allows to select two different delay time base (SHORT BASE and LONG BASE) or ONE SHOT. Please refer to "TIMING FUNCTIONS" paragraph for procedure indications.

WARNING: the maximum mechanical rotation range of the trimmer is 240°. Do not force over of the maximum and minimum positions.

INSTALLATION

The sensor can be positioned by means of the two housing holes using two screws (M5x35 or longer, 1.2Nm maximum tightening torque). The sensor bottom surface has been provided of two mechanical threaded insert M5x5.5. These metal insert are commercial components. Various orientable fixing brackets to ease the sensor positioning are available (please refer to the accessories listed in the general catalogue).

The operating distance is measured from the front surface of the sensor optics. For a correct use, the sensor must be installed orthogonal respect the direction of the object to detect like show in the figure.

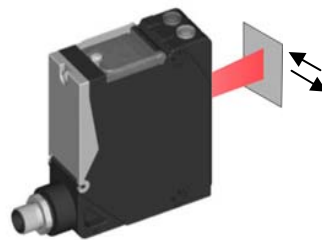

Tighten all screws surely to maintain the water-proof characteristics for IP67 (IEC/EN60529). Excessive tightening causes damage. Tighten the screws within the tightening torque range shown in the table.

TIGHTENING TORQUE (Nm)	
Terminal screws(6pc)	0.5 max
Covers screws	0.5...0.8

The cable gland assure mechanical retention compliant with EN50262.

CABLE DIAMETER	LOAD (N)
4.5..8mm	30
8..10mm	42

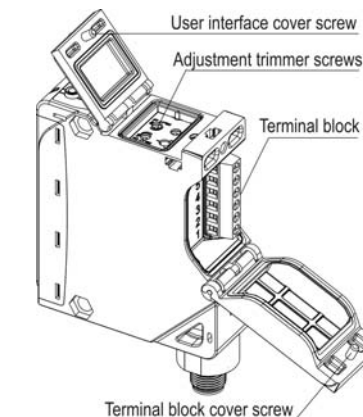

TECHNICAL DATA

AC MODELS	S300-PR-1-M	DC MODELS	S300-PR-2/5-M
Power supply:	24...240 VAC / 24...60 VDC	Power supply:	10...30 VDC Class 2 (UL508)
Ripple:	10 % max	Ripple:	10 % max
Current consumption (output current excluded):	< 3 VA	Current consumption (output current excluded):	< 35 mA
Outputs:	Electromechanical SPDT: 250 VAC, 30 VDC	Outputs:	PNP / NPN open collector R pull-up/down = 47KΩ 100 mA (resistive load)
Output current:	Max 3 A (resistive load)	Output current:	2.4 V max
Response time:	20 ms	Diagnostic functions	PNP ALARM output / Test+ input
Switching frequency:	25 Hz	Response time:	2 ms
Weight:	150 g	Switching frequency:	250 Hz
		Weight:	140 g

Common data

Emission type:	INFRARED LED (880nm)
Operating distance (typical value):	400..2500mm
Difference (90% white / 4% black):	< 15 % at the max distance
Hysteresis (90% white):	< 10 %
Indicators:	OUTPUT LED (YELLOW), STABILITY LED (GREEN)
Adjustment:	15 turns adjustment screw / DARK/LIGHT trimmer Versions with timing functions: time base selection and one shot trimmer / ON DELAY trimmer / OFF DELAY trimmer
Time base (Versions with timing functions):	SHORT BASE: 0...2 sec, LONG BASE: 0...10 sec
Operating temperature:	-40...55 °C
Storage temperature:	-40...70 °C
Dielectric strength:	□: 1500 VAC, 1 min between electronics and housing
Insulating resistance:	> 20 MΩ, □500 VDC between electronics and housing
Ambient light rejection:	EN 60947-5-2
Vibration:	0.5 mm amplitude, 10 ... 55 Hz frequency, for every axis (EN60068-2-6)
Shock resistance:	11 ms (30 G) 6 shock for every axis (EN60068-2-27)
Housing:	PBT 30% Glass fiber-reinforced
Lenses:	frontal window and lens in PC
Protection class:	IP67 (IEC / EN60529) / gland EN50262
UL requirements:	60-70°C copper conductor 24-20 AWG; TYPE 1 ENCLOSURE
Connections:	see the "CONNECTIONS" paragraph

CONNECTIONS

AC MODELS	DC MODELS
N.O. 6	PNP 6
COM 5	NPN 5
N.C. 4	ALARM 4
3	TEST + 3
N 2	- 2
L 1	+ 1
	10...30 VDC

M12 CONNECTOR (only DC models)

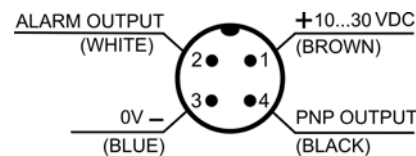

Terminal block versions (S300-PR-1/2)

Use a cable of 4,5 to 10 mm in diameter to ensure water- and dust-proof characteristics. The trasversal section of the cable must be between 16 and 26AWG. The length of conductor peel must be 6mm and the cable peel must be 100mm.

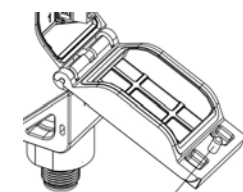

To favour the cable connection it is possible remove (and then replace) the terminal block cover when it is in the maximum opening position (like showed in the figure). Turn off the power supply before wiring. Connect correctly to prevent damage. At the end of the connections, screw the cable gland decisively to lock the cable. Close the terminal block cover with the screw.

M12 connector versions (S300-PR-5)

The connector wires are just connected like show in the previous figure. It is possible change the wiring and use other functionality (NPN output, TEST+ input).

SETTING

Suppression distance setting

- Position object to detect in front of the sensor at the distance required. Turn distance adjustment screw (ADJ) to minimum: yellow LED OFF. Rotate trimmer in a clockwise direction until the yellow LED turns ON. *Object detection condition (pos.A).*
- Remove object and ensure that the background is in front of the sensor: yellow LED OFF. Rotate screw in a clockwise direction until the yellow LED turns ON: *background detection condition (pos.B).*
- Rotate screw in an anti-clockwise direction until the trimmer reaches an intermediate point between position A and C. The sensor is now ready to function correctly in stable conditions.

DIAGNOSTIC FUNCTIONS

S300 has the following diagnostic functions to verify the correct operation on application.

TEST+ input (only S300-PR-2/5)

The TEST+ input can be used to inhibit the emitter and verify that the system is correctly operating. The TEST function is activated if the TEST+ input is connected to a voltage between 12...30V, whereas if the TEST+ input is connected to GND or it is not connected the function is deactivated. Activating the TEST while an object is in front of the sensor (output ON in light mode), the output switches from ON to OFF, testing the total operation. Activating the TEST without an object in front of the sensor (output OFF in light mode), the outp switches from OFF to ON, testing only the output operation.

ALARM output (only S300-PR-2/5)

The alarm output switches ON whenever the received signals remains without a safety margin (greater than 30% compared to the output switching level). The ALARM output is activated when the sensor detects an object in instability conditions (stability LED OFF, OUT LED ON) for 10 times consecutively. If the commutations number is lower, the count down is reset and restart only in instability condition. The ALARM output remain ON until there is a commutation in stability condition.

DIMENSIONS

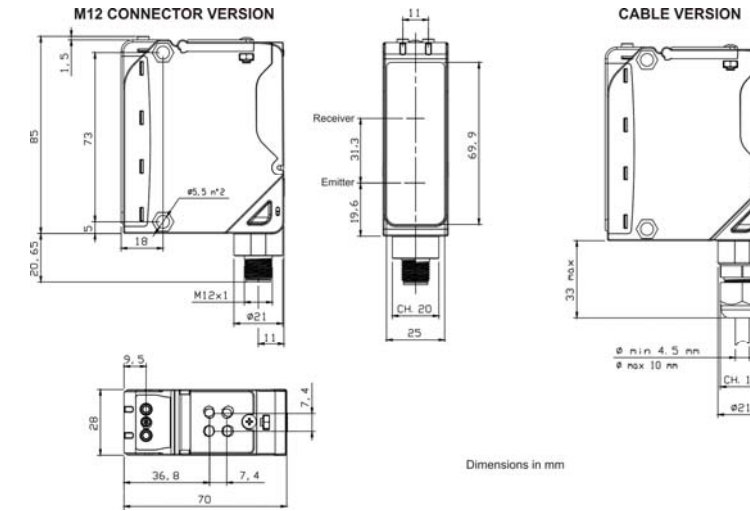

TIMING FUNCTIONS

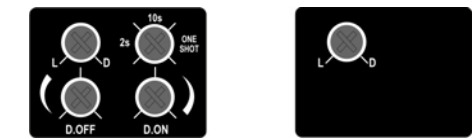

Vers.with timing functions

Vers.without timing functions

The TIME BASE SELECTION trimmer allows to select the time base or the ONE SHOT function.

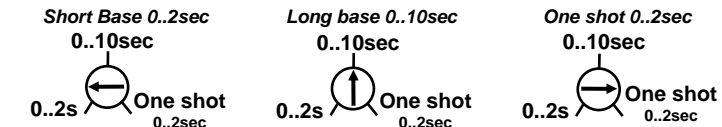

Selecting the short base the time setting of ON delay and OFF delay trimmer is in the range 0..2sec, selecting long base is in the range 0..10sec. To allow a better setting of little delay, the variation of ON and OFF delay are not linear with mechanical regulation of the trimmer: until half rotation the regulation is thinner, whereas from half to full scale the regulation is faster. The follow figure indicates the values of initial, middle and full scale delay of ON and OFF delay trimmer in the two different selectable time base:

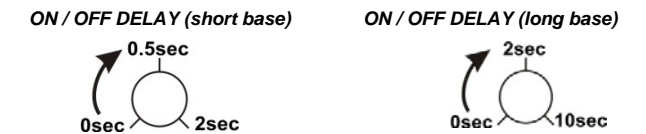

The TIME BASE SELECTION trimmer has a third position to select ONE SHOT mode. The ONE SHOT duration is selectable by ON DELAY trimmer with short time base (0...2 sec). In this mode the OFF delay trimmer is disabled.

TIMING DIAGRAM (S300-x-xxxT)

OPERATION MODE	OUTPUT
Normal (timing disable)	[Timing diagram showing normal output pulses]
ONE SHOT (only with short time base 0...2 sec.)	[Timing diagram showing one shot output pulse]
ON/OFF delay	[Timing diagram showing ON and OFF delay pulses]
ON delay	[Timing diagram showing ON delay pulse]
OFF delay	[Timing diagram showing OFF delay pulse]

The sensors are NOT safety devices, and so MUST NOT be used in the safety control of the machines where installed.

DECLARATION OF CONFORMITY

We Datalogic Automation declare under our sole responsibility that these products are conform to the 2004/108/CE and successive amendments.

WARRANTY

Datalogic Automation warrants its products to be free from defects. Datalogic Automation will repair or replace, free of charge, any product found to be defective during the warranty period of 36 months from the manufacturing date. This warranty does not cover damage or liability deriving from the improper application of Datalogic Automation products.

DATALOGIC AUTOMATION srl

Via Lavino 265 - 40050 Monte S.Pietro - Bologna - Italy
Tel: +39 051 6765611 - Fax: +39 051 6759324 www.datalogic.com

DATALOGIC AUTOMATION cares for the environment: 100% recycled paper.

DATALOGIC AUTOMATION reserves the right to make modifications and improvements without prior notification.

© 2009 - 2013 Datalogic Automation - ALL RIGHTS RESERVED - Protected to the fullest extent under U.S. and international laws. * Copying, or altering of this document is prohibited without express written consent from Datalogic Automation. Datalogic and the Datalogic logo are registered trademarks of Datalogic S.p.A. in many countries, including the U.S.A. and the E.U.