

M0814-MP

8mm F1.4

for 2/3" format cameras

C-Mount

Model No.	M0814-MP		Effective	Front	f 21.5mm
Focal Length	8mm		Lens Aperture	Rear	f 12.0mm
Max. Aperture Ratio	1 : 1.4		Distortion		-1.1%(y=4.0)
Max. Image Format	8.8 x 6.6mm (f11mm)		Back Focal Length		13.1mm
Operation Range	Iris	F1.4 - 16C	Flange Back Length		17.526mm
	Focus	0.3m - Inf.	Mount		C-Mount
Control	Iris	Manual	Filter Size		M30.5 P=0.5mm
	Focus	Manual	Dimensions		f33.5 x 28.2mm
Object Dimension at M.O.D.	32.1 x 24.1cm		Weight		70g
Angle of View	D	67.1°	1/2"	51.9°	
	H	56.3°		42.5°	
	V	43.7°		32.4°	
Operating Temperature	-20°C ~ +50°C				

2/3

C

M.O.D. : Minimum Object Distance

Dimensions

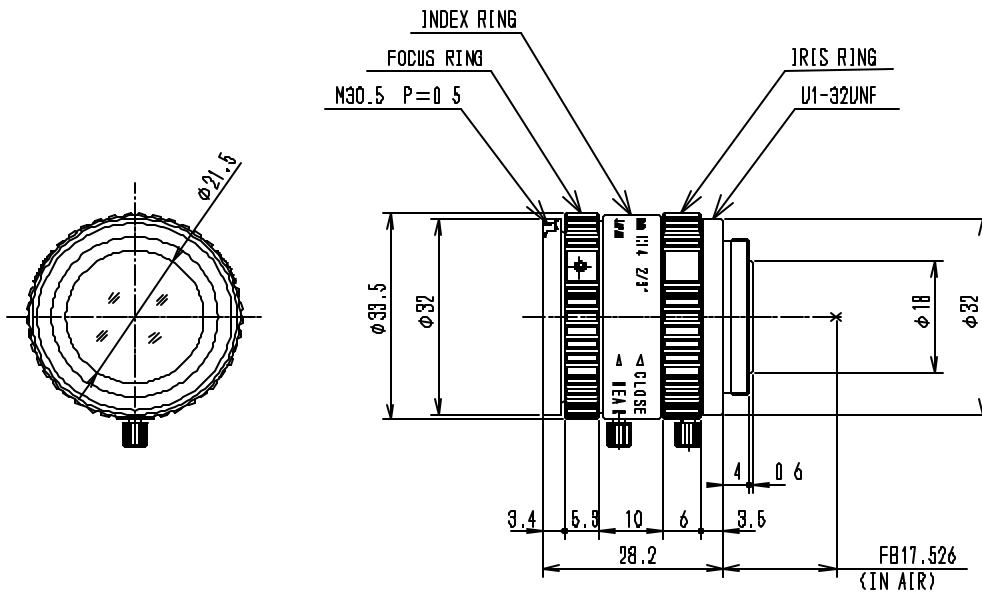

F