

# Digital Fiber Amplifier

## D2RF/D2GF Series

Analog Output Model  
D2RF-TAN D2RF-TAP  
D2RF-2TAN D2RF-2TAP

### Instruction Manual

- Thank you for purchasing DSA-Series. We hope you are fully satisfied with this product and enjoy its performance.
- Carefully read this instruction manual and keep it for future reference.

Carefully read and understand the safety precautions before operation. The important information is provided to protect your health and property. Do not apply any other installing or operating procedure other than that described in this manual.

### Safety Precautions



- It is dangerous to wire or attach/remove the connector with the power on. Make sure to turn off the power before operation.
- Make sure to use the product with the protective cover attached and closed.
- Installing in the following places may result in malfunction:
  - A dusty or steamy place
  - A place generating corrosive gas
  - A place directly receiving scattering water or oil.
  - A place suffered from heavy vibration or impact.
- The product is not designed for outdoor use.
- Do not use the sensor in transient state after power on (approx. 100 ms).
- Do not wire with the high voltage cable or the power line. Failure to do this will cause malfunction by induction or damage.
- The sensor performance or digital display values may depend on the individual units or the condition of detected product.
- This product is not an explosion-proof construction. Do not use the product under flammable, explosive gas or liquid environment.
- Do not use the product in water.
- Do not disassemble, repair, or convert the product. Failure to do this may cause failure, fire, or electric shock.
- Operate within the rated range.

This product cannot be used as a safety device to protect human body.

### Input/Output Schematic

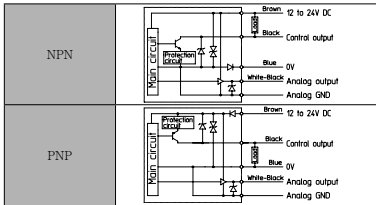

	Standard	D2RF-TA (N/P)
Cable type	IP66	D2RF-2TA (N/P)
Power source, voltage	12-24V DC ±10% (including a ripple)	
Consumption current	45mA or less / 24V (When not using analog output.)	
Response time	60µs/250µs/2ms (Fast/Standard/Long)	
Control output	NPN / PNP Open collector 100mA / 30V or less	
Output method	Light on / Dark on	Switching type in the function
Short-circuit protection	Incorporated	
Light source	Red LED	
Indicator light / Display	Orange (output) / 7 segment 8 digit display	Teaching / Manual adjustment
Sensitivity setting	OFF, On delay timer, Off delay timer, One-shot timer	
Timer function	1ms-9s	
Operating temperature/humidity	-25 ~ +55°C / 35 ~ 85%RH (No freezing and No condensation)	
Storage temperature/humidity	-40 ~ +70°C / 35 ~ 85%RH (No freezing and No condensation)	
Shock resistance	10 ~ 55Hz Amplitude 1.5mm 2 hours for each direction of X, Y and Z	
Protective category	IP50 / IP66	
Material	PPE : Case , PC / Cover, Case (IP66)	
Weight (Including cordes)	70g	

### Each Part

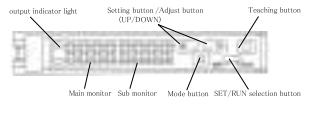

### Setting Amplifier

#### Attaching and Removing to/from DIN rail

##### Attachment of Amplifier Unit

Hook the claw of the connecting side of fiber cable to the DIN rail. Then press down the hook until it locks.

##### Removal of Amplifier Unit

Pushing the unit to the direction of ①, hold up the connecting side of fiber cable and remove the unit.

#### How to connect the fiber cables

- Open fiber lock lever.
- Insert fiber into holes to stop.
- Return fiber lock lever until it stops.

#### CAUTION

With Coaxial reflection fiber, set single core fiber or white-lined fiber to the emitter. Then set Multi wick fiber to the receiver

#### How to use Fine fiber

- Turn adapter cap anticlockwise completely, then appropriately insert the fiber. Be locked by turning adapter cap clockwise.
- Cut the excess fiber with fiber cutter.

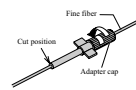

### Adjustment

#### Setting Maximum Sensitivity

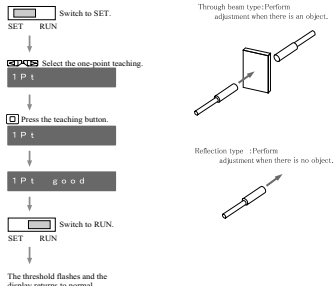

#### One Point Teaching

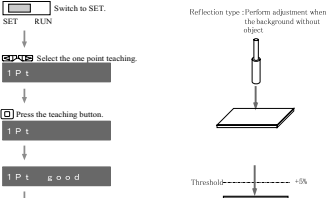

#### Two Points Teaching

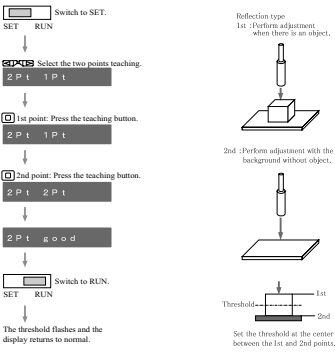

#### Auto Teaching

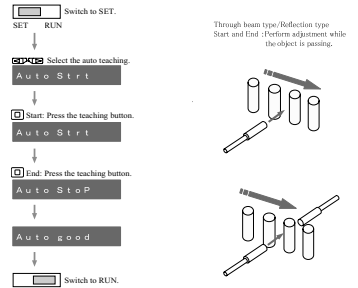

#### Zone Teaching

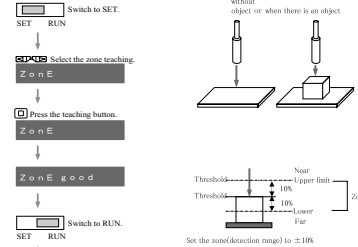

#### Teaching Transparent Object

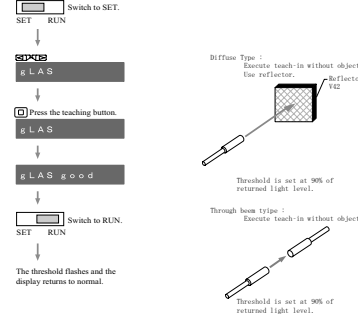

### Manual Adjustment

Pressing the UP/DOWN button in the RUN mode flashes the threshold. It indicates that adjustment is possible. Adjust to any value using the UP/DOWN button.

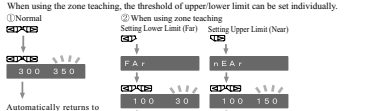

### Error Display in Teaching

An error message is displayed in the event of error during adjustment.

Err 1	Indicates shortage of light intensity or no difference of light intensity.
Err 2	Indicates a sampling error in teaching of a moving object.
Err 3	Indicates a calculation error.
no 1 / PL 1	Indicates that the teaching is interrupted.

### Function Setting

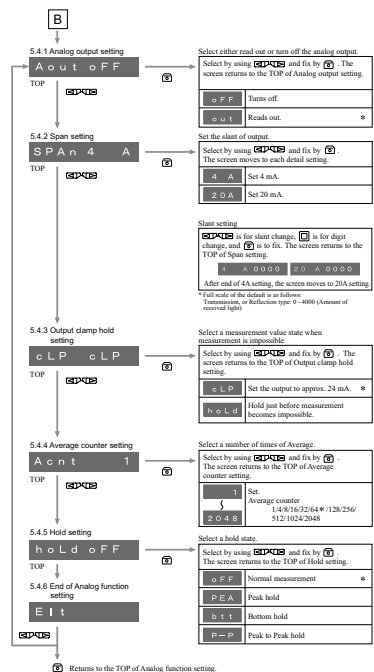
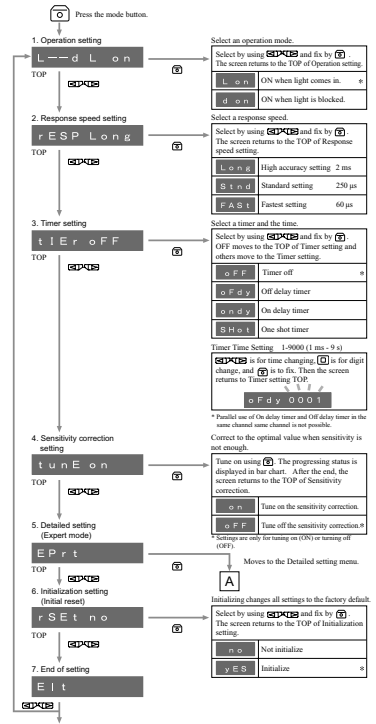

#### Precautions for Function Setting

- no means factory default setting.
- Invalid settings are not indicated automatically. These are not any troubles and failures.
- Hold down the operation button for approx. 0.3 seconds if not especially specified.
- The sub monitor starts flashing when each setting selection becomes available.

#### Returning to Normal Display with One Button

Pressing the [ ] button for 2 seconds or more in setting each function enables to return to the normal display (RUN mode) without using Exit (Exit).

#### Key Lock

Cancels all the operations. Useful to prevent accidental operation. Hold down the [ ] buttons for 2 seconds or more simultaneously in the RUN mode. Operate in the same way to cancel as well.

#### Reset "Peak/ Bottom hold"

Peak/Bottom hold can be reset by operating with amplifier itself at the time of analog output.

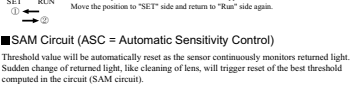

#### SAM Circuit (ASC = Automatic Sensivity Control)

Threshold value will be automatically reset as the sensor continuously monitors returned light. Sudden change of returned light, like cleaning of lens, will trigger reset of the best threshold computed in the circuit (SAM circuit).

This function is valid when Transparent Teaching Mode.

#### APC (Auto Power Control)

Emission LED power is continuously kept at same level compensating damping of LED in the long run of working time. For this function detection level is kept same as preset level.

#### Dimensional drawing

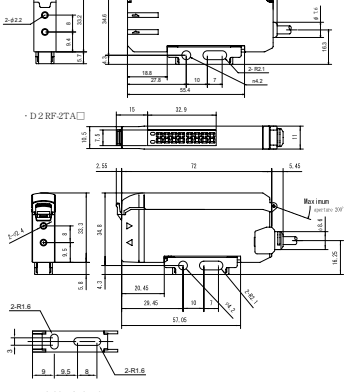

#### Options

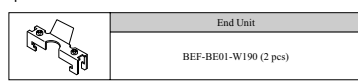

- Specifications and equipment are subject to change without any obligations on the part of manufacturer.
- For more information, questions and comments regarding products, please contact us below.

Manufactured and sold by:  
**OPTEX FA CO., LTD.**  
Head office: Mitsui Seimei Kyoto Yamashina BLDG 6F, 46-1Takehachidondonnae-cho, Yamashina-ku, Kyoto 607-8085 Japan  
TEL: +81-(0)75-594-8123  
FAX: +81-(0)75-594-8124