

HOKUYO

PL d Category3 | SIL 2 Type3

Safety Laser Scanner UAM-05LP-T301

The Smallest Size in the World
with a Versatile Range for
Safety Applications

Actual
Size



“Small and light!”



Compact and Easy to Use

The compact design for installation on AGVs, AGCs as well as in vertical guarding applications.

Size | Height 95.0× Width 80.0× Length 80.0 mm

Weight | 0.8 kg

Conformity Standards

IEC61496-1/3 Type3
 IEC61508 SIL 2
 ISO13849-1 PL d Category3
 UL508
 UL1998
 UL61496-1 Type3
 CSA C22.2 No. 14



Collision Prevention

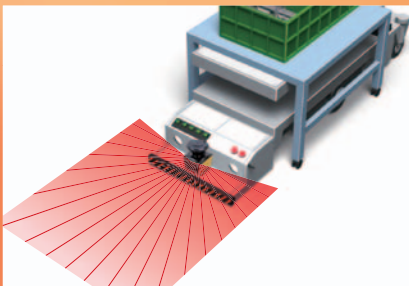

32 area patterns to accommodate the AGV travel path for collision prevention.

Presence Detection

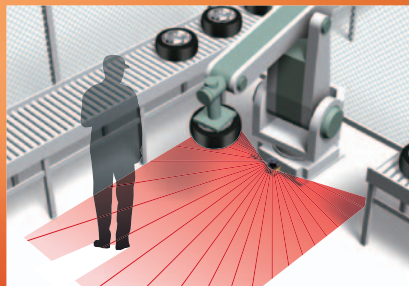

Detects humans or object entering the hazardous area.

Intrusion Detection



Detects access into critical zone. Reference boundary monitoring feature improves the safety by detecting the gaps around the protection zone and sensor's misalignment.

Expands The Range of Safety Applications

Protection over a Wide Range

Up to 5 meters of protection zone and 20 meters of warning zone configuration to suit various application requirement.



Data Output via Ethernet

Measurement data can be acquired via Ethernet with status of input/output signals and cyclic redundancy check code. Also supports command in SCIP2.0 protocol.

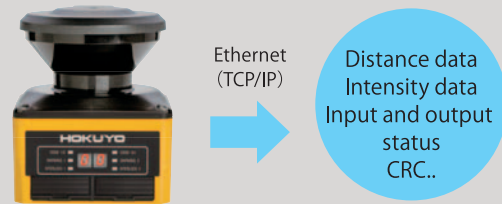

SD card for Configuration

Configuration data can be saved in a SD card which in turn can be used for configuring the UAM without connecting it to a PC. The feature is useful while replacing the UAM or configuring multiple units with the same settings.



Master-Slave Function

Maximum 4 units of UAM can be interconnected for Master-Slave operation when multiple units are required to guard the hazardous area. The system can be controlled by connecting the input and output signals to Master unit only. Important Note: It is not possible to control the actuators via master-slave bus communication.

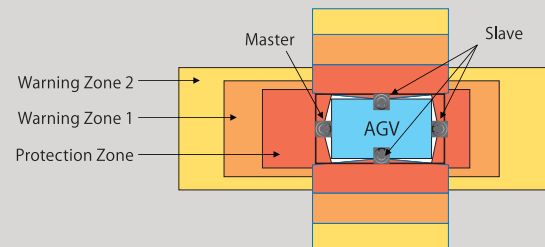

Encoder Input

In AGV applications, area is switched depending on the vehicle's speed. Speed and direction of travel provided via encoders are constantly monitored to switch the area and stop the AVG during abnormal travel.

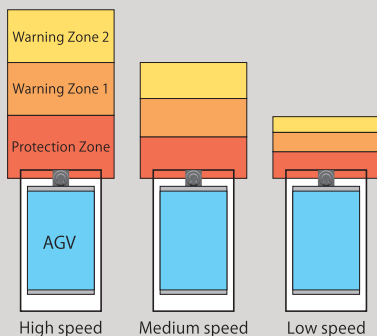

Dual Protection Mode

UAM can simultaneously protect two hazardous areas. Separate OSSD signals are triggered for the respective protection zones making it possible to guard two machines with a single UAM.

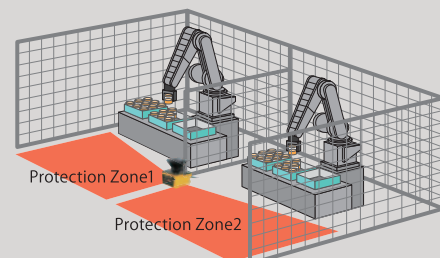

Easy Configuration of Complicated Zones

User Friendly Interface

Simple user interface to configure even a complicated zone by simultaneously viewing the measurement data. Zones can be configured with 3 different methods.

Before settings

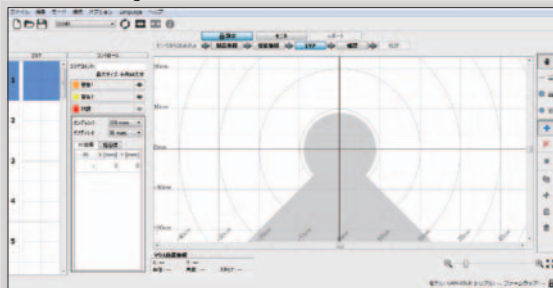

After settings

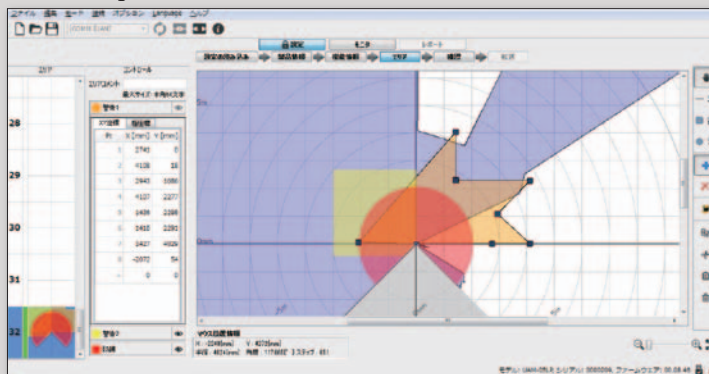

Category

Main unit

| Appearance | Model number | Product code | Notes |
|---|---------------|--------------|---|
|  | UAM-05LP-T301 | UUAM005 | CD-ROM consists of the configurator software and manual |

Extension cable (Option)

| Appearance | Specification | Model number | Product code | Notes |
|---|-------------------|--------------|--------------|-------------|
|  | Cable length: 10m | UAM-5C10 | UZ00066 | Bare cables |
| | Cable length: 20m | UAM-5C20 | UZ00067 | |





USB cable (Option)

| Appearance | Specification | Model number | Product code | Notes |
|---|-------------------------|--------------|--------------|-----------------------|
|  | Micro USB Length: 1m | UAM-MUSB | UZ00065 | For UAM configuration |

Ethernet cable (Option)

| Appearance | Specification | Model number | Product code | Notes |
|---|---------------|--------------|--------------|--|
|  | Length: 3m | UAM-ENET | UZ00062 | Ethernet cable is necessary for distance data output |

Brackets and optical window (Option)

| Appearance | Specification | Model number | Product code | Notes |
|---|-----------------------|--------------|--------------|---|
|  | Base mounting bracket | UAM-BK03 | UZ00059 | |
|  | Rear mounting bracket | UAM-BK04 | UZ00060 | |
|  | Cover bracket | UAM-BK05 | UZ00061 | To protect the optical window |
|  | Optical window | UAM-W002 | UZ00064 | For replacement when damaged and only to be fitted by approved personnel. |

UAM Configurator (Option)

| Appearance | Specification | Model number | Product code | Notes |
|---|---------------|--------------|--------------|---|
|  | CD-ROM | UAM-CD03 | UZ00063 | UAM Configurator for functions and zone configuration |

Specification

| Subject | | Specifications |
|--------------------------|---|--|
| Model | | UAM-05LP-T301 |
| Detection property | Protection Range | Max : 5m |
| | Warning Range | Max : 20m (Non-safety) *1 |
| | Distance Tolerance *2 | +100mm |
| | Detection Capability | From Black-Reflector Sheet (1.8%) to Retro-Reflector Sheet |
| | Detection Range | 270° |
| | Minimum Detectable Width | φ30mm (Max : 1.8m) φ50mm (Max : 3.0m) φ70mm (Max : 5.0m) |
| | Scan Frequency | 30ms (Rotational Speed 2000rpm) |
| | Area Pattern | Max 32 patterns |
| Optics | Response Time | OFF 60ms~510ms ON 270ms~510ms |
| | Element | Pulsed Laser Diode |
| | Wave Length | 905nm |
| | Safety Class | Laser Class 1 |
| Type | | Type 3 (IEC 61496-1, IEC 61496-3) |
| Functional Safety | | SIL 2 (Type B, HFT=1) (IEC61508) |
| PFH _d | | 7.8×10 ⁻⁸ (T1=20 year) : When master slave function is not in use. 1.6×10 ⁻⁷ (T1=20 year) : When master slave function is in use. |
| Housing | Size | 80.0mm (W), 80.0mm (D), 95.0mm (H) (without cable) |
| | Weight | 0.8kg |
| | Protection | IP65 |
| | Case Material | Body : Aluminum / Optical Window : Polycarbonate |
| | Connection Cable | Flying lead cable length : 3m |
| Power Supply | | DC 24V ±10% : when operation using converter power supply DC 24V -30%/+20% : when operation using battery |
| Supply Current | Normal (without load) | 6W |
| | Max. (with load) | 50W |
| Output | OSSD1/2 (Safety) | Output type (High side SW) Output current (Max : 500 mA) *3 Leak current (Max : 1mA) AWG 26 Load tolerance (L/R=25ms, C=1μF) |
| | OSSD3/4 (Safety) WARNING 1/2 (Non-Safety) | Output type (High side SW) Output current : (Max : 250mA) *3 Leak current (Max : 1mA) AWG 28 Load tolerance (L/R=25ms, C=1μF) |
| | RES_REQ 1 RES_REQ 2 MUT_OUT 1 MUT_OUT 2 | Output type (PNP Transistor) Output current : (Max : 200mA) *3 Leak current (Max : 1mA) AWG 28 |
| Input | Area pattern 32 (5 Inputs x 2 Channels) EDM1/EDM2 MUTING1/MUTING2 MUTING3/MUTING4 OVERRIDE1 OVERRIDE2 RESET1/RESET2 ENC_A1/ENC_A2 ENC_B1/ENC_B2 | Input Impedance 4.7 kΩ AWG 28 |
| Interface | Configuration | USB2.0 (USB micro type-B connector) |
| | Data output | Ethernet 100BASE-TX (Water proof connector) |
| Environmental Resistance | Temperature | -10°C to +50°C (No freezing) |
| | Storage Temperature | -25°C to +70°C (No freezing) |
| | Humidity | 95% RH with no condensation |
| | Storage Humidity | 95% RH with no condensation |
| | Surrounding Intensity *4 | Less than 1500lx |
| | Vibration | Frequency range : 10~55Hz Sweep rate : 1 octave/min Amplitude : 0.35mm ±0.05mm |
| Bump | | Acceleration : 98m/s ² (10G) Pulse duration : 16ms |
| Outdoor Operation | | Not permitted |
| Altitude | | Below 2000m |

*1. Distance when reflectance of the object is 90% or above.

*2. Additional distance of 200 mm is needed when the UAM is working under high reflective background.

*3. Total current supply of OSSD output and Warning output should be below 1.0A.

*4. When the light sources are located at ≥5° from the detection plane of UAM.

Wiring example

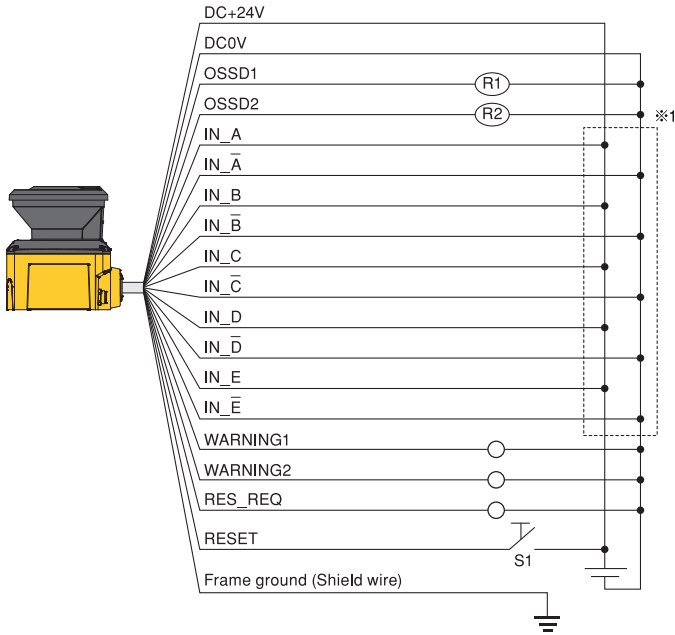

R1 and R2 : External equipment (Safety relay, Electromagnetic contactor)
S1: Interlock reset switch

*1: Refer to user's manual section 3.5 for details on area switching.

| Color | Signal | Function | Description | AWG |
|----------------|---------------------------|---------------|--|-----|
| Brown | +24V DC | Power | Power Supply : DC 24V | 22 |
| Blue | 0V DC | Power | Power Supply : DC 0V | 22 |
| Red | OSSD1 | Output | Protection area output 1 | 26 |
| Yellow | OSSD2 | Output | Protection area output 2 | 26 |
| Red/Black | OSSD3/ WARNING1 | Output | Protection area output 3/ Warning area output 1 | 28 |
| Yellow/Black | OSSD4/ WARNING2 | Output | Protection area output 4/ Warning area output 2 | 28 |
| Purple | IN_A | Input | Area Switching Input A | 28 |
| Gray | IN_B/ MUTING3 | Input | Area Switching Input B/ Muting input 3 | 28 |
| White | IN_C/OVERRIDE1/ ENC1_A | Input | Area Switching Input C/Override input 1/Encoder input 1_A | 28 |
| Pink | IN_D/MUTING1/ ENC1_B | Input | Area Switching Input D/Muting input 1/Encoder input 1_B | 28 |
| Green | IN_E/EDM1 | Input | Area Switching Input E/ External device monitoring 1 | 28 |
| Purple/Black | IN_A-bar | Input | Area Switching Input A invert | 28 |
| Gray/Black | IN_B/ MUTING4 | Input | Area Switching Input B invert/ Muting input 4 | 28 |
| White/Black | IN_C/OVERRIDE2/ ENC2_A | Input | Area Switching Input C invert/ Override input 2/Encoder input 2_A | 28 |
| Pink/Black | IN_D/MUTING2/ ENC2_B | Input | Area Switching Input D invert/ Muting input 2/Encoder input 2_B | 28 |
| Green/Black | IN_E/EDM2 | Input | Area Switching Input E invert External device monitoring 2 | 28 |
| Yellow/Green | RESET1 | Input | Reset input 1 | 28 |
| Yellow/Blue | RESET2 | Input | Reset input 2 | 28 |
| Orange | RES_REQ1/ MUT_OUT1 | Output | RES_REQ 1 : Request output 1 MUT_OUT 1 : Muting state output 1 | 28 |
| Orange/Black | RES_REQ2/ MUT_OUT2 | Output | RES_REQ 2 : Request output 2 MUT_OUT 2 : Muting state output 2 | 28 |
| White/Blue(TP) | RS485+ | Communication | Communication Protocol RS485 | 28 |
| White/Red(TP) | RS485- | Communication | Communication Protocol RS485 | 28 |
| Shield wire | FG | - | Frame ground | - |

Input/Output circuit

OSSD output circuit

OSSD/Warning output is output type.

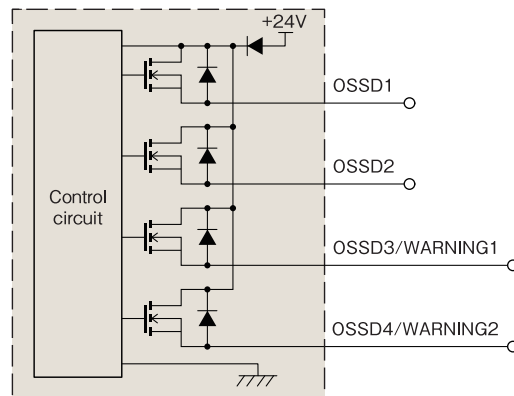

Other Output circuit

RES_REQ1, RES_REQ2, MUT_OUT1,
MUT_OUT2 output circuit.

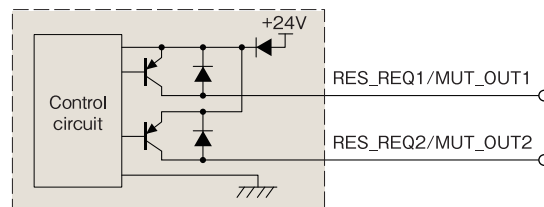

Input circuit

Area input, EDM1, EDM2, RESET1,
RESET2, MUTING1, MUTING2,
MUTING3, MUTING4, OVERRIDE1,
and OVERRIDE2

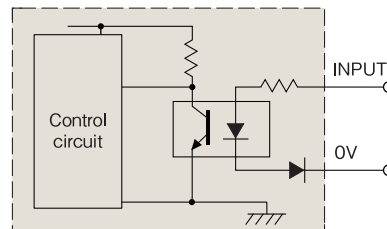

External Diagram

Sensor

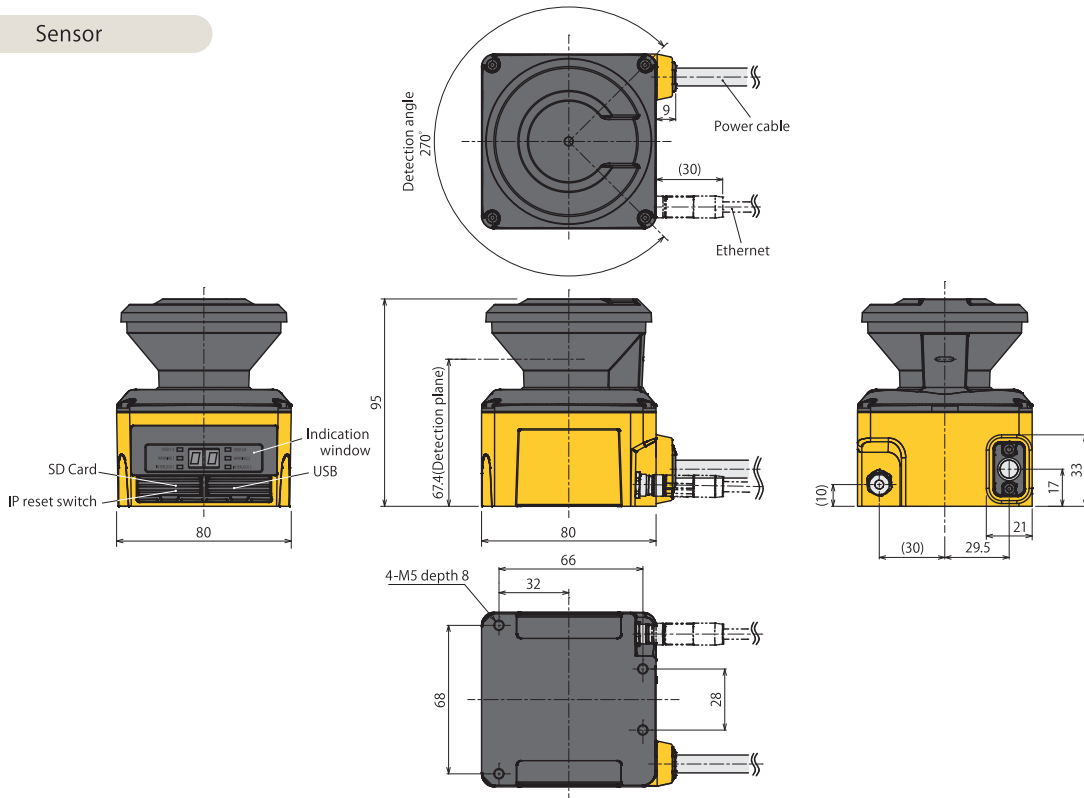

Fixed Condition of Rear mounting bracket with Cover bracket

Fixed Condition of Base mounting bracket with Cover bracket

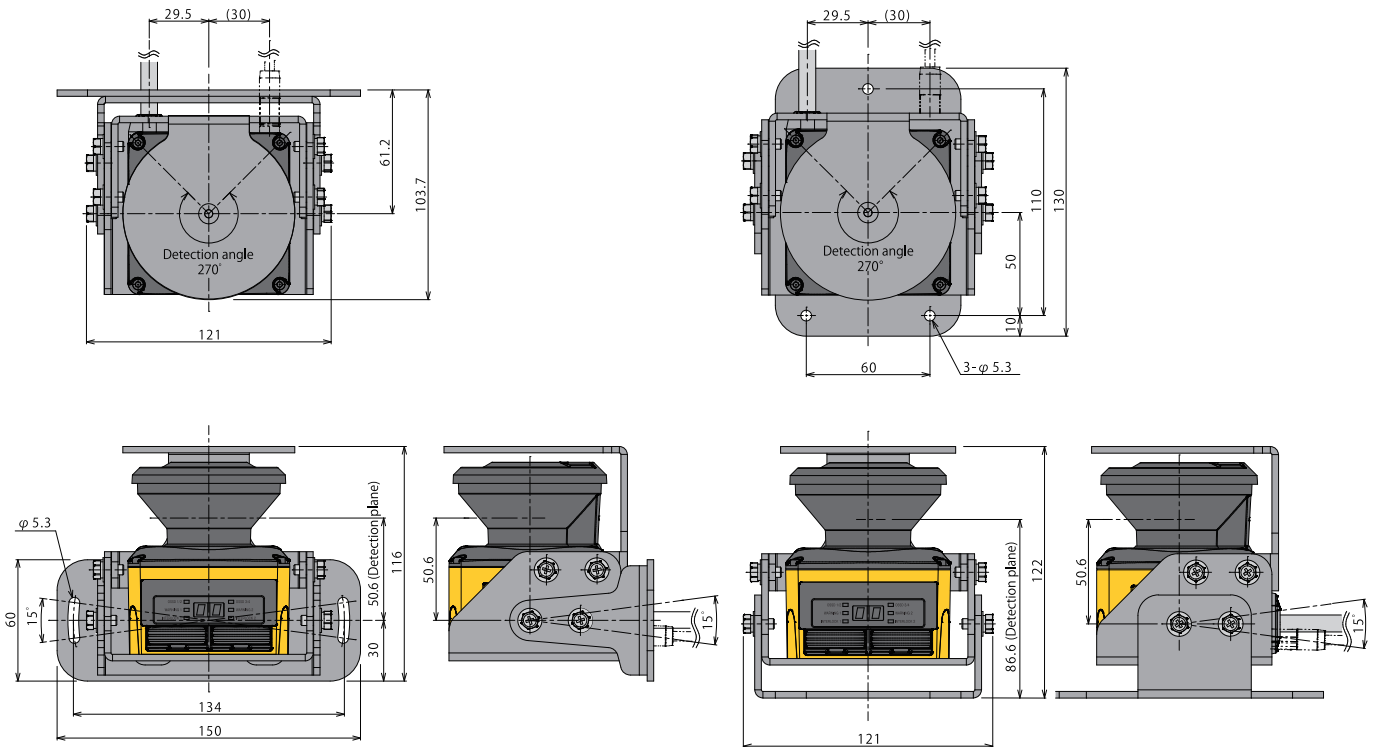

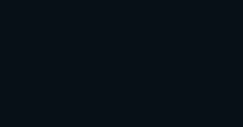

ISO14001 Certified
JQA-EM3873



ISO9001 Certified
JQA-1742



Caution for safety use

- Read instruction manual and brochure carefully before use.
- Products published in this brochure are intended to be used under certain conditions.
- For product related questions or technical issues, please contact our office.



HOKUYO AUTOMATIC CO.,LTD.

Osaka HU Building, 2-2-5 Tokiwamachi, Chuo-Ku,
Osaka, Japan. 540-0028

TEL: +81-6-6947-6333 FAX: +81-6-6947-6350

URL <http://www.hokuyo-aut.jp>

E-mail: info@hokuyo-aut.jp

- The contents of this catalog are based on material from October 2015. External dimensions and specifications may change without notice.